

Part number

CAPS 10.21



Surface mounting housing, EMC series, with 2 levers, Pg21 cable entry, size "57.27", high construction

Product description		Material properties	
Product type	Surface mounting housing	Other materials	Lever: Stainless steel, polyamide (PA) Gasket: Conductive elastomer
Series	EMC	RoHs conformity	Compliant
Closing type	With 2 levers	China RoHs - EFUP	E
Size	Size 57.27	REACH SVHC substances	No
Cable entry	With cable entry Pg21	Approvals / Standards	
Specification	High construction	Certifications	DNV, BV
Technical data		UL	ECBT2
IP degree of protection	IP65 / IP66 / IP69	cUL	ECBT8
Further technical details		General ordering information	
Weight	392,00 g	EAN13 code	8015747147453
Operating temperature range (min, max)	-40°C...+125°C	Packaging Information	
		Packaging length	475,00 mm
		Packaging height	200,00 mm
		Packaging width	150,00 mm
		Packaging weight	4,40 kg
		Packaging volume	14,25 dm ³
		Packaging description	Carton box
		Packaging quantity	10 Pcs
		Packaging EAN code	8015747248846
		Sub-packaging weight	2,20 kg
		Sub-packaging description	Plastic packaging
		Sub-packaging quantity	5 Pcs
		Sub-packaging EAN barcode	8015747248853

Part number

CAPS 10.21



Catalogue drawings

CHIS

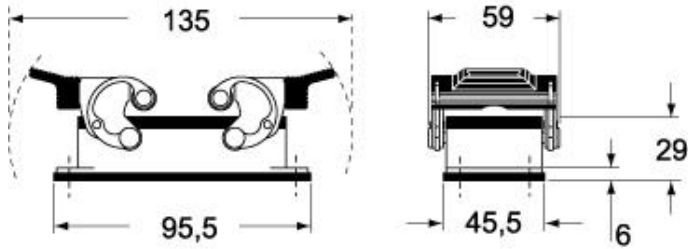

CAPS - MAPS

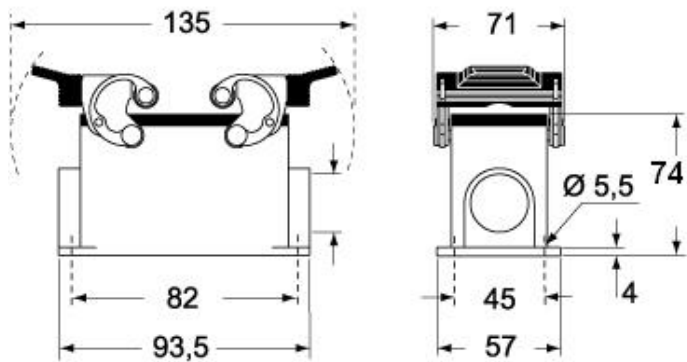

CHCS

