

# Connections for stage equipment LS-TYPE

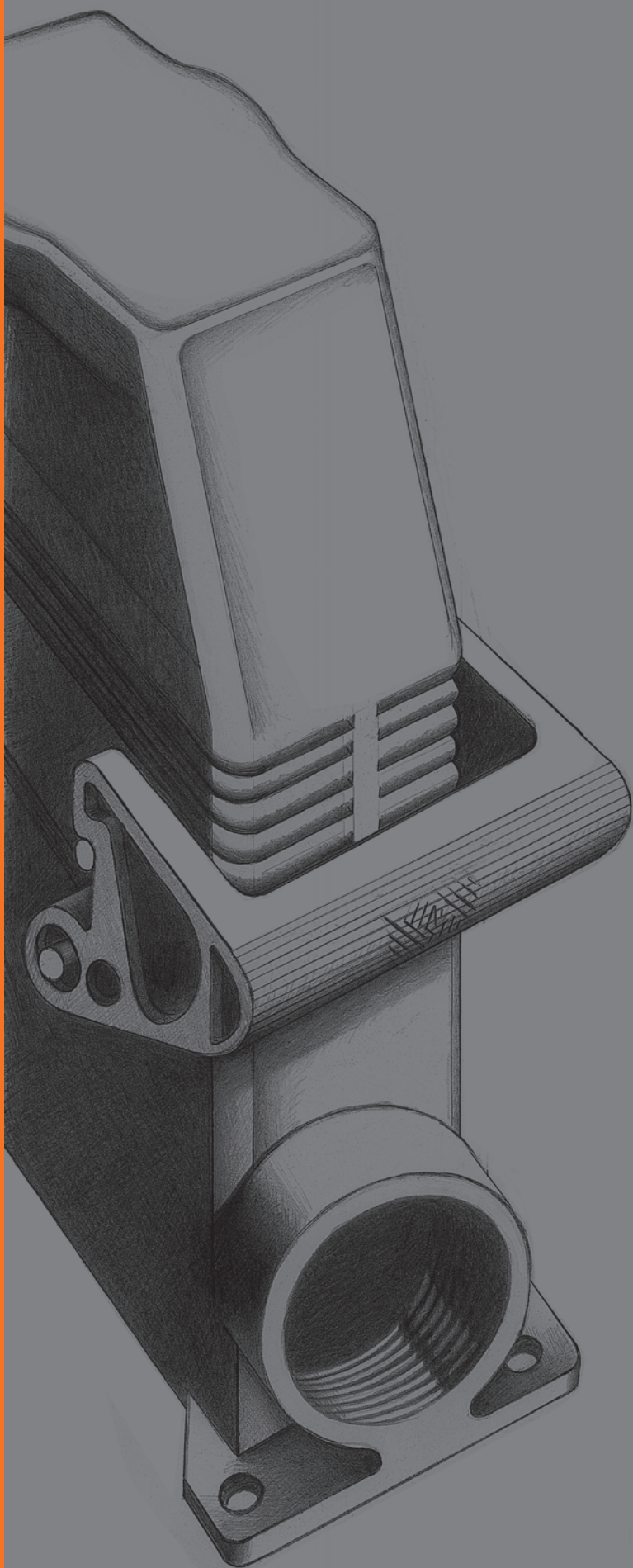

## The Company and the Product

**I.L.M.E. SpA - INDUSTRIA LOMBARDA MATERIALE ELETTRICO** - has been operating in Milan since 1938, in particular in the electrotechnical sector for the manufacturing of equipment for industrial installations.

ILME reflects the traditional **entrepreneurial spirit of Lombardy**, and has enjoyed continuous expansion for over half a century.

The company has carved an important role for itself in the main world markets, also operating directly in the countries that have assumed world leadership in the field of automation, including Germany and Japan.

In the **electrical connection** sector with applications in industrial automation, characterised by **top performance** and utmost **reliability needs**, ILME is today the acknowledged partner of many leading companies worldwide.

The company's fundamental values are:



**product innovation**, original solutions, excellent **price-quality ratio**, a customer-oriented **sense of service**, ethical behaviour and an environmentally-friendly approach.

To promote the continuing improvement of its **qualitative results**, ILME has always encouraged its collaborators to work with utmost **responsibility and participation**. The company focuses on a series of benefits to the user, including research into the most suitable materials, high quality and safe cabling, a rapid turnaround and readily available services.

## CE marking

As from 1 January 1997, in order to launch electrical products on the European market the manufacturer must ensure these bear the relevant CE marking, in line with the Low Voltage Directive 73/23/EEC \* (implemented in Italy as law 18-10-1977 no. 791) and its modification 93/68/EEC \* (implemented in Italy as L. D. 25-11-1996 no. 626/96, published in the supplement to the Gazzetta Ufficiale of 14-12-1996).

The CE marking must be placed on the product - or, if this is not possible, on the packaging, the instructions for use or the warranty certificate - and acts as a declaration by the manufacturer that the product complies with all relevant EU directives.

### ILME products bear the CE marking on the product or packaging.

Almost all ILME products fall within the scope of the Low Voltage Directive. A declaration of compliance is required before applying the CE marking. This document, to which the market is not directly entitled, must be made available to the control authorities (in Italy the Ministry for Industry, Commerce and Handicraft) at all times.

In it, the manufacturer declares the technical safety standard(s) followed to manufacture the product. These standards must be, in decreasing order of preference:

- a European standard (EN prefix)
- a European harmonisation document (HD prefix)
- an international IEC standard
- a national standard
- in the absence of reference standards, the manufacturer's internal specifications, guaranteeing compliance with the directive's basic safety requirements.

Compliance with harmonised technical standards (i.e. ratified by the CENELEC) constitutes presumed conformity to the directive's basic safety requirements.

The CE marking of ILME products results from said products' declaration of conformity to harmonised standards or international IEC standards.

Through the CE marking, ILME declares full compliance, not merely with the directive's basic safety requirements, but also with those

international or national EU standards on which voluntary safety certification markings are based (e.g. IMQ and VDE).

In this way, ILME intends to award the CE marking the value of self-certification in terms of safety, given the loss in legal value of voluntary certifications issued by third parties, ratified by directive 93/68/EEC \*.

Notwithstanding the above, practically all ILME products still bear voluntary conformity markings.

**The above mentioned EU declaration of conformity becomes null and void when the assembly of products includes one or more components not manufactured by ILME and without CE marking.**

### \* Note:

The next legal reference for the Low Voltage Directive was 2006/95/EC, as consolidation of the original Directive 73/23/EEC + Directive 93/68/EEC.

On 29<sup>th</sup> March 2014, the Official Journal of the European Union published the new Low Voltage directive 2014/35/EU dd. 26<sup>th</sup> February 2014, a recast version of directive 2006/95/EC, which is in force since on 20<sup>th</sup> April 2016.

The new **LS-TYPE** enclosures are the ideal solution for the entertainment industry (lighting system power supply and related mixer and dimmer panels), including theatre stages, film sets, radio and TV studios, discos, trade fair booths, concert halls and night public events, both indoors and outdoors, etc.

All parts are in elegant RAL 9005 black to make them suitable for situations and locations where they should not be visible in the dark.

## LS-TYPE connectors



## LS-TYPE Plugs & Sockets

The enclosures are available in the standard sizes 44.27, 57.27, 77.27 and 104.27.

They are designed to accommodate all types of connector inserts (crimp, screw, or spring connections as well as the innovative Squich connection).

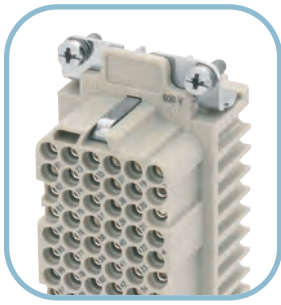

CRIMP

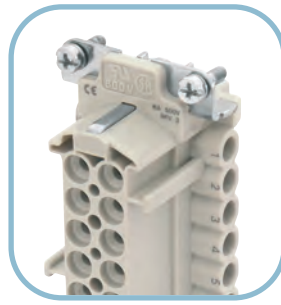

SCREW



SPRING



SQUICH

The metal enclosures maintains the same outstanding characteristics as the grey colour versions.

The overall dimensions and the fastening flanges are unchanged from the corresponding traditional versions. Therefore, the new enclosures can be used as an alternative to the classic version.

The levers are made of thermoplastic material and are easy to replace in case of breakdowns due to severe impacts during the set-up and break down of the stages, lighting systems etc.

### EASY LEVER REPLACEMENT



The suffix N identifies the new **LS-TYPE** series:

- CHIN bulkhead mounting housing with lever(s)
- MAPN surface mounting housing high construction with lever(s)
- MFVN hood with pegs top entry high construction
- MFON hood with pegs side entry high construction
- MFVN G hood with lever(s) and gasket top entry, high construction
- CHCN covers with pegs
- CHCN G covers with lever(s) and gasket

The enclosures provide IP65 degree of protection (in accordance with EN 60529) when coupled and locked through the locking levers. The range of operating ambient temperature is  $-40^{\circ}\text{C} \div +125^{\circ}\text{C}$ .

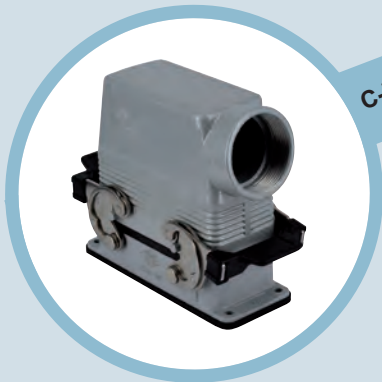

C-TYPE



LS-TYPE

**NEW**



V-TYPE  
IP67



CENTRAL  
LEVER

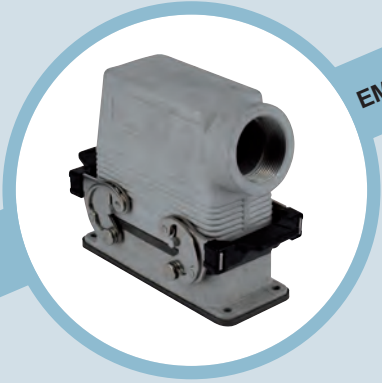

EMC



T-TYPE  
Insulating

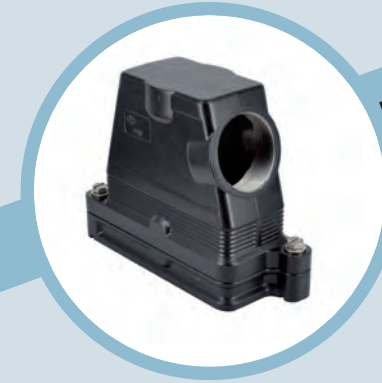

IP68

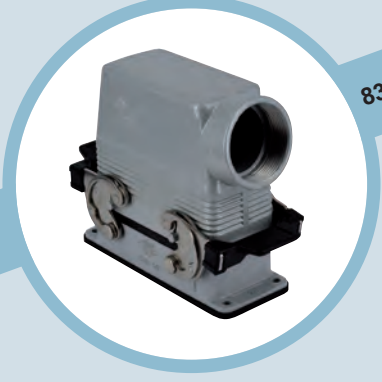

830V



JEI  
Economic



W-TYPE



180 °C

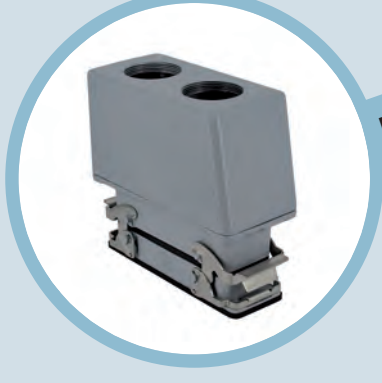

BIG

**SELECT YOUR CONNECTOR  
ENTER YOUR APPLICATION...  
...FIND OUR PROPOSED SOLUTION**

[www.ilme.com](http://www.ilme.com)



inserts:		page
CDD .....	24 poles + ⊕	59 *
CQE .....	10 poles + ⊕	80 *
CSH .....	6 poles + ⊕	88 *
CCE .....	6 poles + ⊕	94 *
CNE, CSE, JCNE, JCSE	6 poles + ⊕ 95 and 106*	
CSS .....	6 poles + ⊕	118 *
CTE, CTSE (**)	6 poles + ⊕	126 *
MIXO .....	2 modules	160+195 *

\*\*) only in the CHIN 06 L enclosure

insert centre distance: 44 x 27 mm

\* refer to catalogue page CN.12

housings with single lever



hoods with 2 pegs



description	part No.	entry M	part No.	entry M
bulkhead mounting housing, with lever	<b>CHIN 06 L</b>			
surface mounting housing, high construction, with lever	<b>MAPN 06 L32</b>	<b>32</b>		
with pegs, side entry			<b>MHON 06 L25</b>	<b>25</b>
with pegs, side entry, high construction			<b>MFON 06 L25</b>	<b>25</b>
with pegs, top entry			<b>MHVN 06 L25</b>	<b>25</b>
with pegs, top entry, high construction			<b>MFVN 06 L25</b>	<b>25</b>

panel cut-out for bulkhead mounting housing in mm

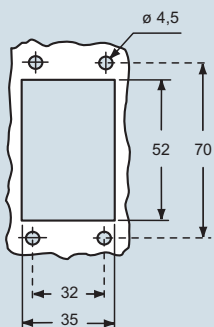

dimensions in mm

**CHIN 06 L**

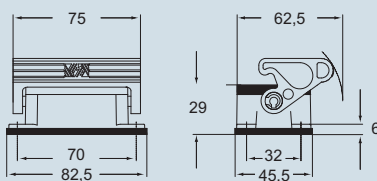

**MAPN 06 L32**

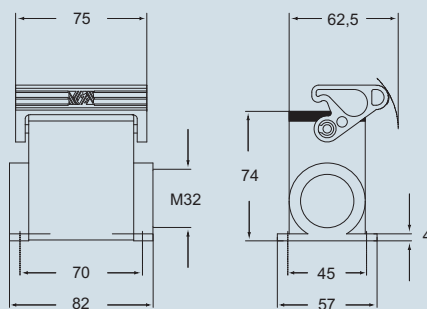

- kiln powder coating with RAL 9005 black epoxy polyester powder
- RAL 9005 black self-extinguishing thermoplastic locking lever (spare lever page 12)

dimensions in mm

**MFON 06 L25**

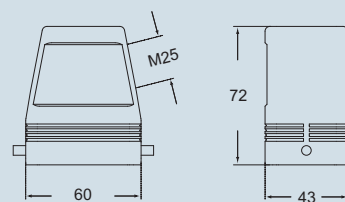

**MFVN 06 L25**

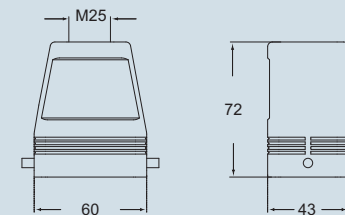

**MHON 06 L25**

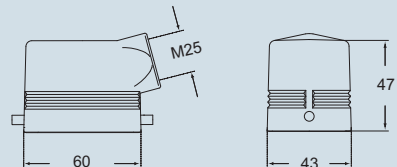

**MHVN 06 L25**

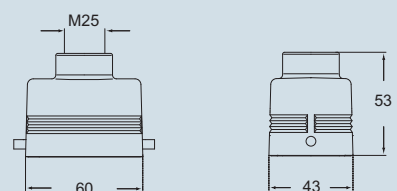

dimensions shown are not binding and may be changed without notice



inserts:	page
CDD ..... 24 poles + ⊕	59 *
CQE ..... 10 poles + ⊕	80 *
CSH ..... 6 poles + ⊕	88 *
CCE ..... 6 poles + ⊕	94 *
CNE, CSE, JCNE, JCSE	6 poles + ⊕ 95 and 106 *
CSS ..... 6 poles + ⊕	118 *
MIXO ..... 2 modules	160+195 *

insert centre distance: 44 x 27 mm

\* refer to catalogue page CN.12

hoods with 2 pegs



covers



description	part No.	entry M	part No.
with lever and gasket, top entry	MHVN 06 LG25	25	
with lever and gasket, top entry, high construction	MFVN 06 LG25	25	

covers with pegs	CHCN 06 L
covers with lever	CHCN 06 LG

- kiln powder coating with RAL 9005 black epoxy polyester powder
- RAL 9005 black self-extinguishing thermoplastic locking lever (spare lever page 12)

dimensions in mm

MHVN 06 LG25

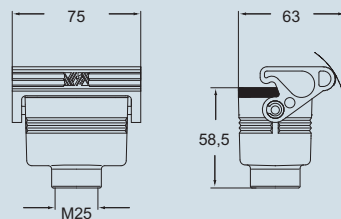

MFVN 06 LG25

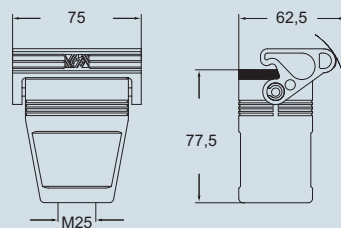

dimensions in mm

CHCN 06 L

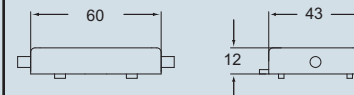

CHCN 06 LG

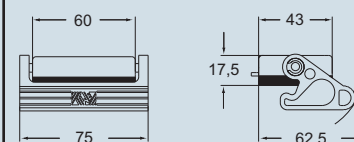

dimensions shown are not binding and may be changed without notice



inserts:		page
CDD .....	42 poles + ⊕	61 *
CQE .....	18 poles + ⊕	81 *
CSH .....	10 poles + ⊕	89 *
CCE .....	10 poles + ⊕	90 *
CNE, CSE, JCNE, JCSE	10 poles + ⊕ 97 and 107 *	107 *
CSS .....	10 poles + ⊕	119 *
CTE, CTSE **)	10 poles + ⊕	127 *
CMSE .....	3+2 (aux) poles + ⊕	135 *
CMCE .....	3+2 (aux) poles + ⊕	134 *
CX .....	8/24 poles + ⊕	151 *
MIXO .....	3 modules	160+195 *

\*\*) only in the CHIN 10 enclosure

insert centre distance: 57 x 27 mm

\* refer to catalogue page CN.12

housings with double lever



hoods with 4 pegs



description	part No.	entry M	part No.	entry M
bulkhead mounting housing, with 2 levers	<b>CHIN 10</b>			
surface mounting housing, high construction, with 2 levers	<b>MAPN 10.32</b>	<b>32</b>		
with pegs, side entry			<b>MHON 10.25</b>	<b>25</b>
with pegs, side entry, high construction			<b>MFON 10.32</b>	<b>32</b>
with pegs, top entry			<b>MHVN 10.25</b>	<b>25</b>
with pegs, top entry, high construction			<b>MFVN 10.32</b>	<b>32</b>

panel cut-out for bulkhead mounting housing in mm

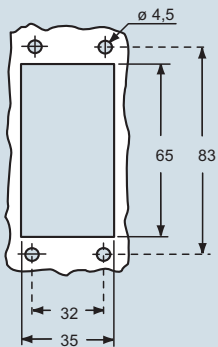

- kiln powder coating with RAL 9005 black epoxy polyester powder
- RAL 9005 black self-extinguishing thermoplastic locking lever (spare lever page 12)

dimensions in mm

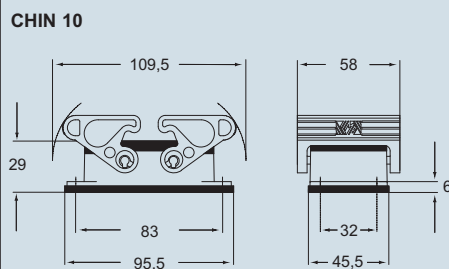

MAPN 10.32

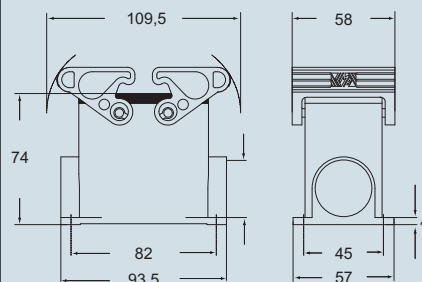

dimensions in mm

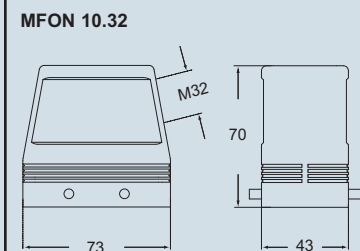

MFVN 10.32

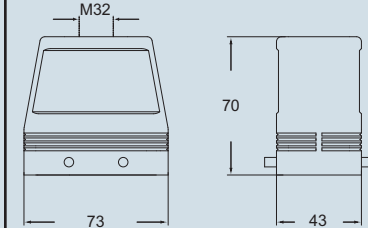

MHON 10.25

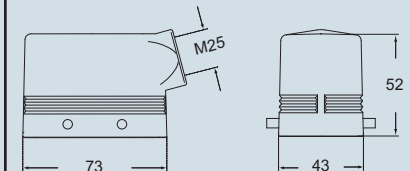

MHVN 10.25

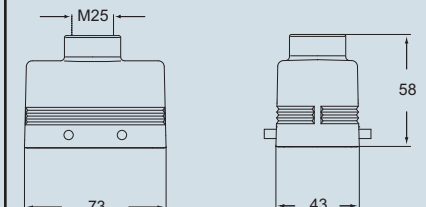

dimensions shown are not binding and may be changed without notice





inserts:	page
CDD ..... 42 poles + ⊕	61 *
CQE ..... 18 poles + ⊕	81 *
CSH ..... 10 poles + ⊕	89 *
CCE ..... 10 poles + ⊕	90 *
CNE, CSE, JCNE, JCSE	10 poles + ⊕ 97 and 107 *
CSS ..... 10 poles + ⊕	119 *
CMSE ..... 3+2 (aux) poles + ⊕	135 *
CMCE ..... 3+2 (aux) poles + ⊕	134 *
CX ..... 8/24 poles + ⊕	151 *
MIXO ..... 3 modules	160+195 *

insert centre distance: 57 x 27 mm

\* refer to catalogue page CN.12

hoods with 4 pegs



covers



description	part No.	entry M
with 2 levers and gasket, top entry	<b>MHVN 10 G25</b>	<b>25</b>
with 2 levers and gasket, top entry, high construction	<b>MFVN 10 G32</b>	<b>32</b>

part No.	entry M
<b>MHVN 10 G25</b>	<b>25</b>
<b>MFVN 10 G32</b>	<b>32</b>

part No.
<b>CHCN 10</b>
<b>CHCN 10 G</b>

covers with pegs  
covers with 2 levers

- kiln powder coating with RAL 9005 black epoxy polyester powder
- RAL 9005 black self-extinguishing thermoplastic locking lever (spare lever page 12)

dimensions in mm

**MHVN 10 G25**

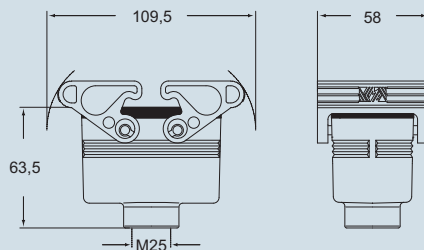

**MFVN 10 G32**

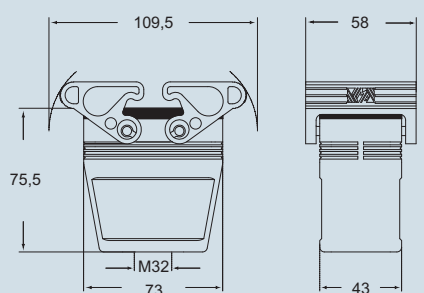

dimensions in mm

**CHCN 10**

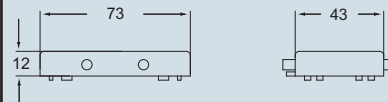

**CHCN 10 G**

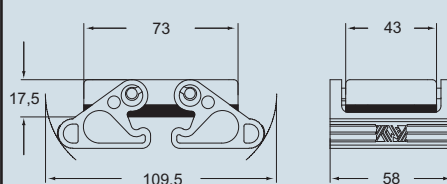

dimensions shown are not binding and may be changed without notice



inserts:	page
CD .....	40 poles + ⊕ 49+52 *
CT, CTS **).....	40 poles + ⊕ 56 *
CDD .....	72 poles + ⊕ 62+65 *
CQE .....	32 poles + ⊕ 82+84 *
CSH .....	16 poles + ⊕ 90+92 *
CCE .....	16 poles + ⊕ 98+102 *
CNE, CSE, JCNE, JCSE	16 poles + ⊕ 99 and 108 *
CSS .....	16 poles + ⊕ 120+122 *
CTE, CTSE **).....	16 poles + ⊕ 128 *
CMSE .....	6+2 (aux) poles + ⊕ 137 *
CMCE .....	6+2 (aux) poles + ⊕ 136 *
CP .....	6 poles + ⊕ 149+150 *
CX .....	6/36 e 12/2 poles + ⊕ 152+153 *
CX .....	4/0 e 4/2 poles + ⊕ 154 *
MIXO .....	4 modules 160+195 *

\*\*) only in the CHIN 16 enclosure

insert centre distance: 77,5 x 27 mm

\* refer to catalogue page CN.12

housings with double lever



hoods with 4 pegs



description	part No.	entry M	part No.	entry M
bulkhead mounting housing, with 2 levers	<b>CHIN 16</b>			
surface mounting housing, high construction, with 2 levers	<b>MAPN 16.32</b>	<b>32</b>		
with pegs, side entry			<b>MHON 16.32</b>	<b>32</b>
with pegs, side entry, high construction			<b>MFON 16.32</b>	<b>32</b>
with pegs, top entry			<b>MHVN 16.32</b>	<b>32</b>
with pegs, top entry, high construction			<b>MFVN 16.32</b>	<b>32</b>

panel cut-out for bulkhead mounting housing in mm

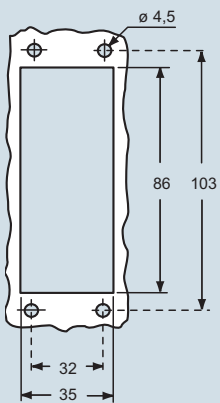

- kiln powder coating with RAL 9005 black epoxy polyester powder
- RAL 9005 black self-extinguishing thermoplastic locking lever (spare lever page 12)

dimensions in mm

CHIN 16

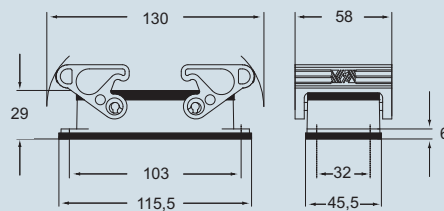

MAPN 16.32

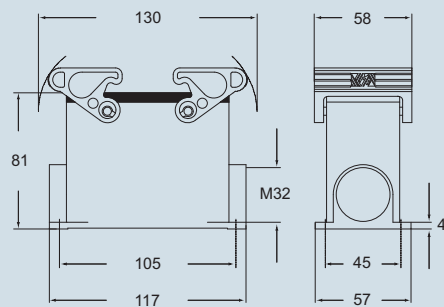

dimensions in mm

MFON 16.32

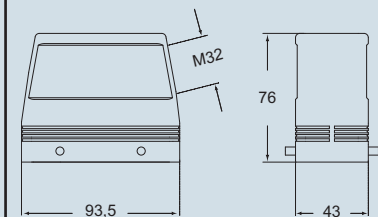

MFVN 16.32

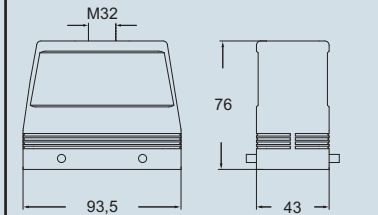

MHON 16.32

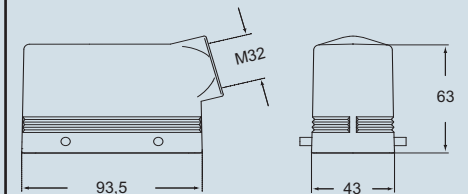

MHVN 16.32

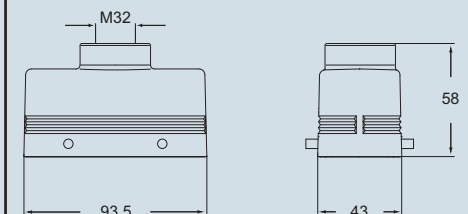

dimensions shown are not binding and may be changed without notice



inserts:	page
CD .....	40 poles + ⊕ 49+52 *
CDD .....	72 poles + ⊕ 62+65 *
CQE .....	32 poles + ⊕ 82+84 *
CSH .....	16 poles + ⊕ 90+92 *
CCE .....	16 poles + ⊕ 98+102 *
CNE, CSE, JCNE, JCSE	16 poles + ⊕ 99 and 108 *
CSS .....	16 poles + ⊕ 120+122 *
CMSE .....	6+2 (aux) poles + ⊕ 137 *
CMCE .....	6+2 (aux) poles + ⊕ 136 *
CP .....	6 poles + ⊕ 149+150 *
CX .....	6/36 e 12/2 poles + ⊕ 152+153 *
CX .....	4/0 e 4/2 poles + ⊕ 154 *
MIXO .....	4 modules 160+195 *

insert centre distance: 77,5 x 27 mm

\* refer to catalogue page CN.12

hoods with 4 pegs



covers



description	part No.	entry M	part No.
with 2 levers and gasket, top entry	<b>MHVN 16 G32</b>	<b>32</b>	
with 2 levers and gasket, top entry, high construction	<b>MFVN 16 G32</b>	<b>32</b>	

cover with pegs cover with 2 levers			<b>CHCN 16</b> <b>CHCN 16 G</b>
--	--	--	------------------------------------

- kiln powder coating with RAL 9005 black epoxy polyester powder
- RAL 9005 black self-extinguishing thermoplastic locking lever (spare lever page 12)

dimensions in mm

**MHVN 16 G32**

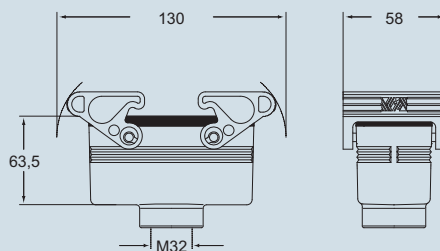

**MFVN 16 G32**

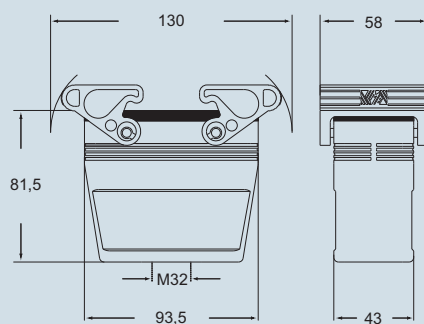

dimensions in mm

**CHCN 16**

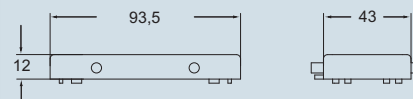

**CHCN 16 G**

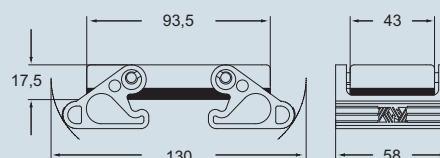

dimensions shown are not binding and may be changed without notice



inserts:		page
CD .....	64 poles + ⊕	51+53 *
CT, CTS **).....	64 poles + ⊕	57 *
CDD .....	108 poles + ⊕	64+66 *
CQE .....	46 poles + ⊕	83+85 *
CSH .....	24 poles + ⊕	91+93 *
CCE .....	24 poles + ⊕	100+104 *
CNE, CSE, JCNE, JCSE	24 poles + ⊕	101 and 109 *
CSS .....	24 poles + ⊕	122+123 *
CTE, CTSE **).....	24 poles + ⊕	129 *
CMSE .....	10+2 (aux) poles + ⊕	139 *
CMCE .....	10+2 (aux) poles + ⊕	138 *
CX .....	4/8 poles + ⊕	155 *
MIXO .....	6 modules	160+195 *

\*\*) only in the CHIN 24 enclosure

insert centre distance: 104 x 27 mm

\* refer to catalogue page CN.12

housings with double lever



hoods with 4 pegs



description	part No.	entry M
bulkhead mounting housing, with 2 levers	<b>CHIN 24</b>	
surface mounting housing, high construction, with 2 levers	<b>MAPN 24.32</b>	<b>32</b>
with pegs, side entry		
with pegs, side entry, high construction		
with pegs, side entry		
with pegs, side entry, high construction		

description	part No.	entry M
with pegs, side entry	<b>MHON 24.32</b>	<b>32</b>
with pegs, side entry, high construction	<b>MFON 24.32</b>	<b>32</b>
with pegs, side entry	<b>MHVN 24.32</b>	<b>32</b>
with pegs, side entry, high construction	<b>MFVN 24.32</b>	<b>32</b>

panel cut-out for bulkhead mounting housing in mm

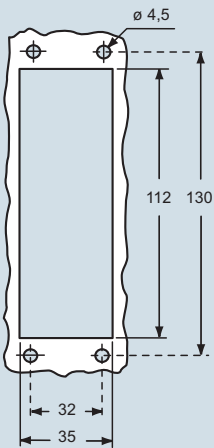

- kiln powder coating with RAL 9005 black epoxy polyester powder
- RAL 9005 black self-extinguishing thermoplastic locking lever (spare lever page 12)

dimensions in mm

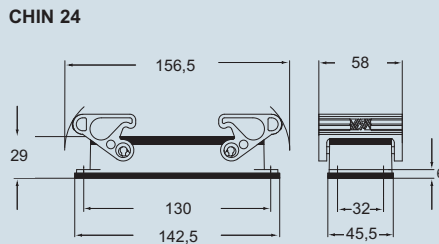

MAPN 24.32

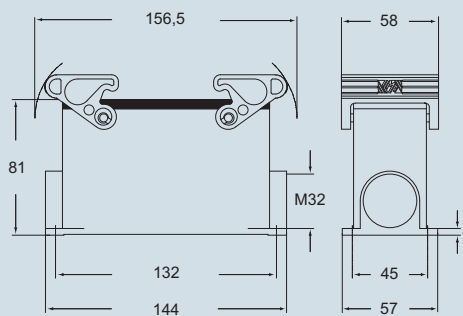

dimensions in mm

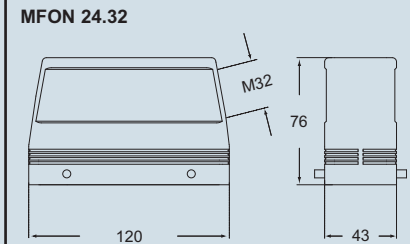

MFVN 24.32

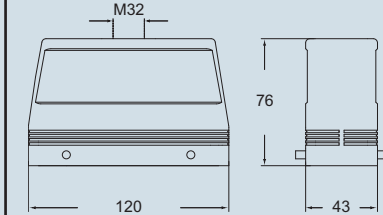

MHON 24.32

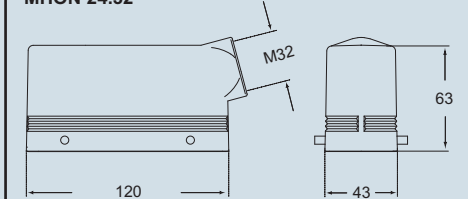

MHVN 24.32

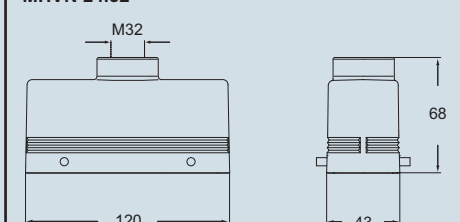

dimensions shown are not binding and may be changed without notice



inserts:	page
CD ..... 64 poles + ⊕	51+53 *
CDD ..... 108 poles + ⊕	64+66 *
CQE ..... 46 poles + ⊕	83+85 *
CSH ..... 24 poles + ⊕	91+93 *
CCE ..... 24 poles + ⊕	100+104 *
CNE, CSE, JCNE, JCSE 24 poles + ⊕	101 and 109 *
CSS ..... 24 poles + ⊕	121+123 *
CMSE ..... 10+2 (aux) poles + ⊕	139 *
CMCE ..... 10+2 (aux) poles + ⊕	138 *
CX ..... 4/8 poles + ⊕	155 *
MIXO ..... 6 modules	160+195 *

insert centre distance: 104 x 27 mm

\* refer to catalogue page CN.12

hoods with 4 pegs



covers



description	part No.	entry M
with 2 levers and gasket, top entry	<b>MHVN 24 G32</b>	<b>32</b>
with 2 levers and gasket, top entry, high construction	<b>MFVN 24 G32</b>	<b>32</b>

part No.	entry M
<b>CHCN 24</b>	
<b>CHCN 24 G</b>	

part No.
<b>CHCN 24</b>
<b>CHCN 24 G</b>

covers with pegs  
covers with 2 levers

dimensions in mm

dimensions in mm

- kiln powder coating with RAL 9005 black epoxy polyester powder
- RAL 9005 black self-extinguishing thermoplastic locking lever (spare lever page 12)

**MHVN 24 G32**

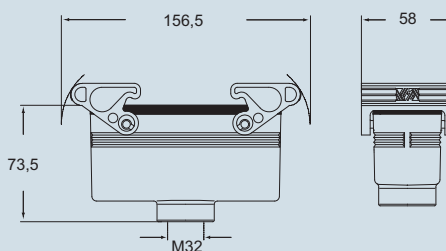

**CHCN 24**

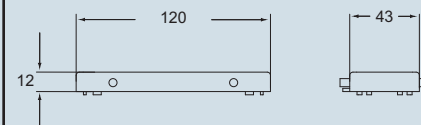

**MFVN 24 G32**

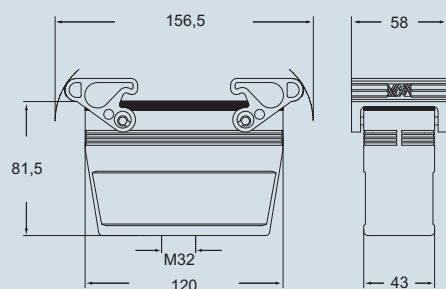

**CHCN 24 G**

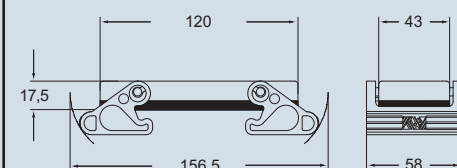

dimensions shown are not binding and may be changed without notice

spare part lever



spare part lever



description

part No.

part No.

for "44.27" enclosures with levers

**CR 06 LN**

for "57.27", "77.27", "104.27" enclosures with levers

**CR LN**

dimensions in mm

**CR 06 LN**

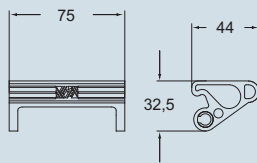

dimensions in mm

**CR LN**

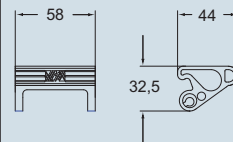

dimensions shown are not binding  
and may be changed without notice

**CK - CKS**  
 Screw terminal connection 10A - 250V  
 Spring connection 10A - 400V  
 ..... from page 40



**CD**  
 Crimp connection 10A - 250V  
 10A - 50V  
 ..... from page 44

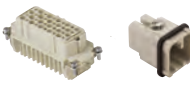

**CT - CTS**  
 Screw terminal connection 10A - 250V  
 Spring connection 10A - 250V  
 ..... from page 54



**CDD**  
 Crimp connection 10A - 250V  
 ..... from page 58



**CQ**  
 Crimp connection 10A/16A/40A  
 ..... from page 67



**CDA - CDC**  
 Screw terminal connection 16A - 250V  
 Crimp connection 16A - 250V  
 ..... from page 72



**CQE**  
 Crimp connection 16A - 500V  
 ..... from page 79



**CSH**  
 Spring connection without tools 16A - 500V  
 ..... from page 86



**CNE - CSE - CCE**  
 Screw terminal connection 16A - 500V  
 Spring connection 16A - 500V  
 Crimp connection 16A - 500V  
 ..... from page 94



**JCNE - JCSE**  
 Screw terminal connection 16A - 500V  
 Spring connection 16A - 500V  
 ..... from page 106



**CSS**  
 Spring connection dual terminal 16A - 500V  
 ..... from page 118



**CT - CTE - CTS**  
 Screw terminal connection 16A - 400V/500V  
 Spring connection  
 ..... from page 124



**C-TYPE** page 200  
 - metallic  
 - CLASS rotative lever  
 - IP65/IP66



**V-TYPE IP67** page 249  
 - metallic  
 - water tightness in a limited space  
 - lever in stainless steel  
 - IP66/IP67



**V-TYPE IP65/IP66** page 260  
 - metallic  
 - water tightness in a limited space  
 - lever in stainless steel  
 - IP65/IP66



**T-TYPE** page 277  
 - insulating  
 - robust  
 - resistant to chemical agents  
 - IP65



**JEI** page 287  
 - metallic  
 - lever in galvanised steel  
 - economic  
 - IP65/IP66



**BIG - HOOD** page 296  
 - large and modular  
 - multiple cable entries  
 - simple and easy cable inspection  
 - seat for electronic boards  
 - IP66



## CMCE - CME - CMSE

Crimp connection 16A - 830V  
Screw terminal connection 16A - 830V  
Spring connection 16A - 830V  
..... from page 134



## CP

Screw terminal connection 35A - 400/690V  
..... from page 149



## CX - MIXED INSERTS

Crimp connection 10A/16A/40A  
..... from page 151



## CX

Screw terminal connection 16A/80A  
..... from page 154



## MIXO

Crimp connection 200A/100A/70A  
40A/16A/10A/5A  
..... from page 160



## MIXO

Screw terminal connection 40A  
..... from page 165

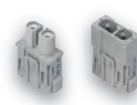

## MIXO

Spring connection 16A  
..... from page 172



## MIXO

Data RJ45-USB-POF  
BUS-COAX  
..... from page 183



## MIXO

Pneumatic  
..... from page 191

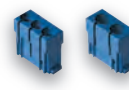

## DESINA

Crimp connection  
..... from page 449



## COB

- mounting inside control panel  
- inspectable  
..... page 408



## PANEL MOUNTING

..... page 427



## W-TYPE

page 322  
- metallic with chrome treatment  
- for aggressive environments  
- IP66



## EMC

page 335  
- for electromagnetic compatibility  
- with conductive gaskets  
- IP66



## 180 °C

page 352  
- metallic  
- for high temperature environments  
- IP65



## CENTRAL LEVER

page 359  
- for limited mounting spaces  
- reduces insert uncoupling stress  
- IP65



## IP68

page 369  
- watertight  
- mechanical robustness  
- resistant to chemical agents  
- screw or bayonet locking



## 830V

page 391  
- insulated for CME  
and CMCE 16p inserts  
- CLASS rotative lever  
- IP65/IP66





inserts:		page
CK	3 poles + ⊕	40 *
CK	4 poles + ⊕	40 *
CKS	3 poles + ⊕	41 *
CKS	4 poles + ⊕	41 *
CD	7 poles + ⊕	45 *
CD	8 poles	46 *
CQ	5 poles + ⊕	69 *
CQ	12 poles + ⊕	68 *

insert dimensions:  
21 x 21 mm

\* page references CN.12 catalogue

bulkhead mounting housings



angled bulkhead mounting housings



description	part no.	part no. (entry - Pg 11)	part no. (entry - M 20)
with lever	CK 03 IN (black)		
without cable gland entry, with lever		CK 03 IAN (black)	
with cable gland entry and lever		CK 03 IAPNS (black)	MK IAPN20 (black)
gasket and screw kit for IP66/IP67 <sup>1)</sup> for CK, CQ 05, CKS inserts	CKR 65	CKR 65	
gasket and screw kit for IP66/IP67 <sup>1)</sup> for CD 07/08 inserts	CKR 65 D	CKR 65 D	

1) To obtain the protection rating IP66/IP67 a kit is provided that includes a gasket to fit under the insert fixing screws supplied with the kit (see illustrative example)  
CQ 12 inserts are already supplied with a gasket and screw which ensure IP66/IP67 protection rating

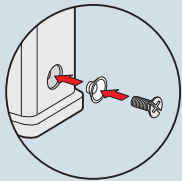

panel cut-out for enclosures, in mm

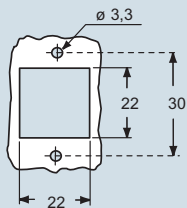

dimensions in mm

CK IN

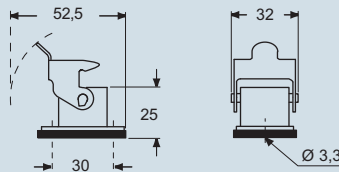

dimensions in mm

CK IAN

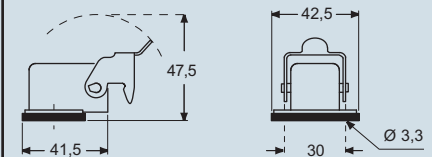

CK IAPNS and MK IAPN

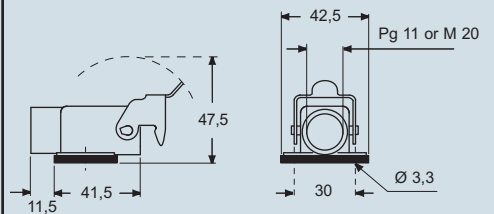

**CRUS**® Type 12  
Type 4/4X only  
with CKR 65 (D)



IP66/IP67 with CKR 65 (D) <sup>1)</sup>

dimensions shown are not binding  
and may be changed without notice

inserts:		page
CK .....	3 poles + ⊕	40 *
CK .....	4 poles + ⊕	40 *
CKS .....	3 poles + ⊕	41 *
CKS .....	4 poles + ⊕	41 *
CD .....	7 poles + ⊕	45 *
CD .....	8 poles	46 *
CQ .....	5 poles + ⊕	69 *
CQ .....	12 poles + ⊕	68 *

insert dimensions:  
21 x 21 mm

\* page references CN.12 catalogue

hoods



covers



description	part no. (entry - Pg 11)	part no. (entry - M 20)	part no.
with pegs, top entry	<b>CK 03 VNS</b> (black)	<b>MK VN20</b> (black)	
with pegs, top entry	<b>CK 03 VANS</b> (black)	<b>MK VAN20</b> (black)	
with lever, top entry	<b>CK 03 VGNS</b> (black)	<b>MK VGN20</b> (black)	
with pegs and gasket, for female inserts with pegs, for male inserts			<b>CK 03 CN</b> (black) <b>CK 03 CAN</b> (black)
with lever and gasket, for female inserts with lever, for male inserts			<b>CK 03 CXN</b> (black) <b>CK 03 CXAN</b> (black)
gasket and screw kit for IP66/IP67 <sup>1)</sup> for CK, CQ 05, CKS inserts	<b>CKR 65</b>		
gasket and screw kit for IP66/IP67 <sup>1)</sup> for CD 07/08 inserts	<b>CKR 65 D</b>		

1) To obtain the protection rating IP66/IP67 a kit is provided that includes a gasket to fit under the insert fixing screws supplied with the kit (see illustrative example)  
CQ 12 inserts are already supplied with a gasket and screw which ensure IP66/IP67 protection rating

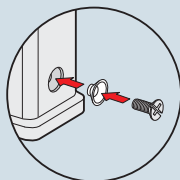

dimensions in mm

CK VNS and MK VN

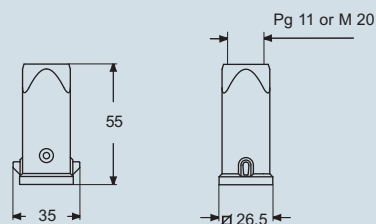

CK VANS and MK VAN

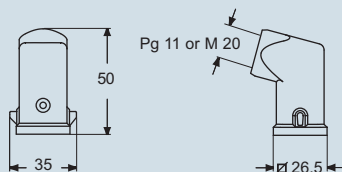

CK VGNS and MK VGN

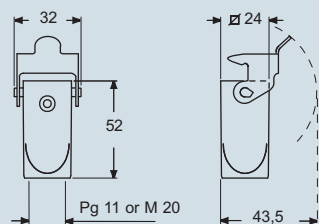

dimensions in mm

CK CN

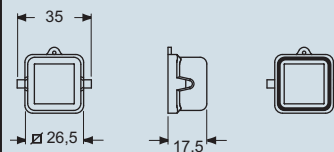

CK CAN

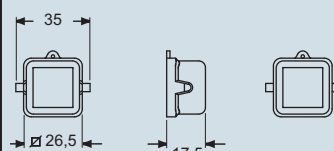

CK CXN

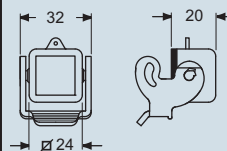

CK CXAN

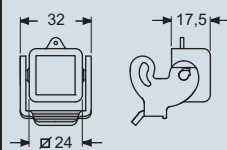

**CRUS**® Type 12  
Type 4/4X only  
with CKR 65 (D)



IP66/IP67 with CKR 65 (D) <sup>1)</sup>

dimensions shown are not binding  
and may be changed without notice

## **pluso-N** - Plugs and sockets for LS-TYPE version

**pluso**

These products are the ideal choice for the entertainment industry (to supply lighting equipment and mixer/dimmer assemblies) and are typically used on theatre stages, cinema sets, radio and television broadcasting studios, discos, fair stands, concert halls, public night events, both indoors and outdoors, and similar scenarios.

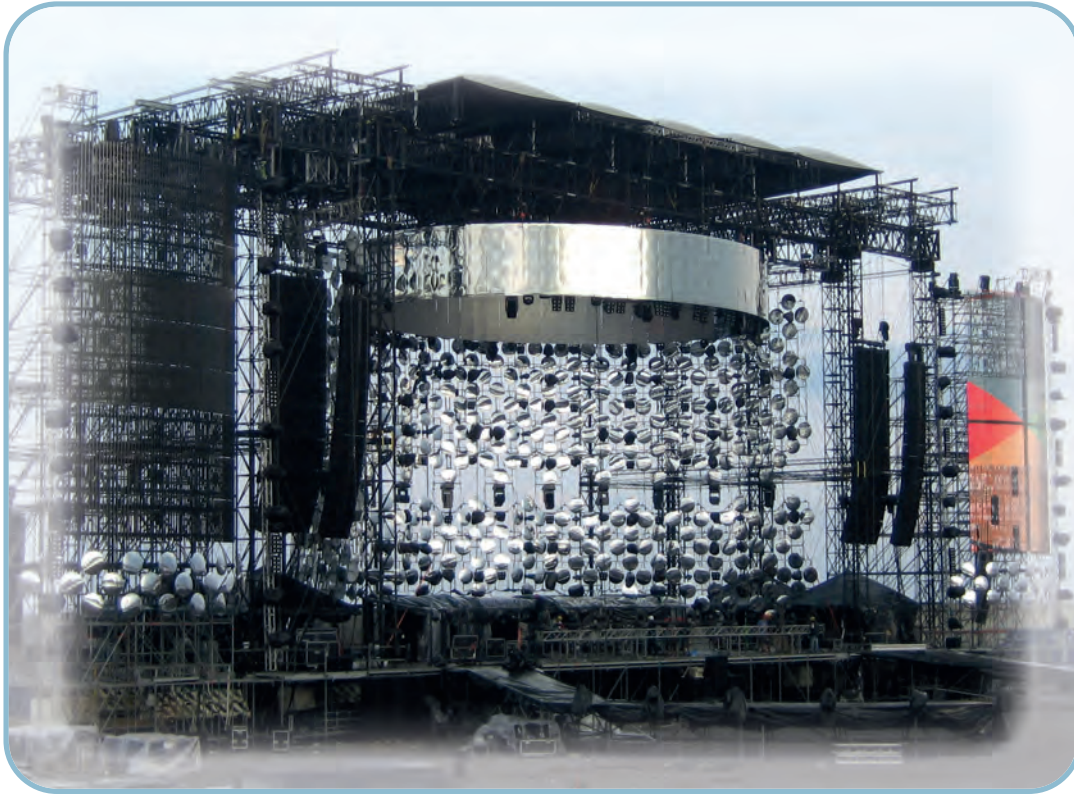

## pluso-N - Plugs and sockets for LS-TYPE version

pluso

All models share the extraordinary features of the equivalent versions in grey colour.

The elegant colour of all visible plastic parts and the labels in non reflecting grey, which are used only when the markings are not printed, add a touch of discretion and make these products particularly suitable for scenarios and areas where plugs, sockets and cables should be invisible in absence of light.

The range includes several models:

Couplers, flush-mounting, with IP44 protection degree or IP67 on request (couplers and sockets have an IP66/IP67 protection degree).

**NOTE** - Products are available with different voltage and/or frequency and current ratings on request.



# PN...SV coupler plugs - PN...PV coupler socket-outlets LS-TYPE



- PN...SV types 16A (IP44), entry with cable gland colour RAL 9005 black, enclosure colour RAL 9005 black
- PN...PV types 16A (IP44), enclosure and spring lid colour RAL 9005 black, entry with cable gland
- Compliant with EN 60309-1 and -2
- PN...SV types, enclosure and insert in insulating, thermoplastic, self-extinguishing material
- PN...PV types, enclosure, insert and spring lid in insulating, thermoplastic, self-extinguishing material
- Terminals with retained screws
- IP44 degree of protection (EN 60529)

**16A coupler plugs**  
**IP44 degree of protection**  
**low voltage:**  
**from over 50V up to 690V**



**NEW**

**16A coupler socket-outlets**  
**IP44 degree of protection**  
**low voltage:**  
**from over 50V up to 690V**



**NEW**

Number of poles	Frequency Hz	Voltage V	Earthing contact position h	Part No.	Part No.
<b>2P+⊕</b>	50 and 60	200 ÷ 250	6	<b>PN 1663 SV</b>	<b>PN 1663 PV</b>
<b>3P+⊕</b>	50 and 60	380 ÷ 415	6	<b>PN 1664 SV</b>	<b>PN 1664 PV</b>
<b>3P+N+⊕</b>	50 and 60	200/346 ÷ 240/415	6	<b>PN 1665 SV</b>	<b>PN 1665 PV</b>

dimensions in mm

(16A) PN ... SV

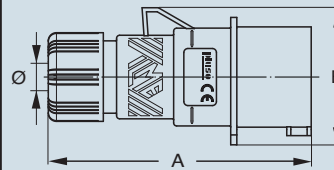

PN...SV	A	B	ø min	ø max
<b>16A 2P+⊕</b>	129	59.5	7	16
<b>3P+⊕</b>	129	67	7	16
<b>3P+N+⊕</b>	129	75	8	24

dimensions in mm

(16A) PN ... PV

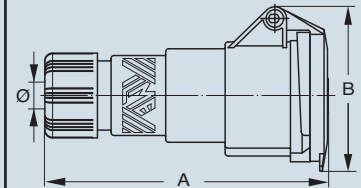

PN...PV	A	B	ø min	ø max
<b>16A 2P+⊕</b>	146	74.5	7	16
<b>3P+⊕</b>	146	84.5	7	16
<b>3P+N+⊕</b>	146	92.5	8	24

dimensions shown are not binding  
 and may be changed without notice

- Enclosure and spring lid colour RAL 9005 black
- Compliant with EN 60309-1 and -2
- Enclosure, insert and spring lid in insulating, thermoplastic, self-extinguishing material
- Flange with anti-ageing gasket
- PN...PI - PN...PQ types (IP44), spring lid
- Terminals with retained screws
- IP44 degree of protection (EN 60529)

**16A flush-mounting inclined socket-outlets**  
**IP44 degree of protection**  
**low voltage:**  
**from over 50V up to 690V**



**NEW**

**16A flush-mounting straight socket-outlets**  
**IP44 degree of protection**  
**low voltage:**  
**from over 50V up to 690V**



**NEW**

Number of poles	Frequency Hz	Voltage V	Earthing contact position h	Part No.	Part No.
<b>2P+⊕</b>	50 and 60	200 ÷ 250	6	<b>PN 1663 PI</b>	<b>PN 1663 PQ</b>
<b>3P+⊕</b>	50 and 60	380 ÷ 415	6	<b>PN 1664 PI</b>	<b>PN 1664 PQ</b>
<b>3P+N+⊕</b>	50 and 60	200/346 ÷ 240/415	6	<b>PN 1665 PI</b>	<b>PN 1665 PQ</b>

dimensions in mm

(16A) PN ... PI

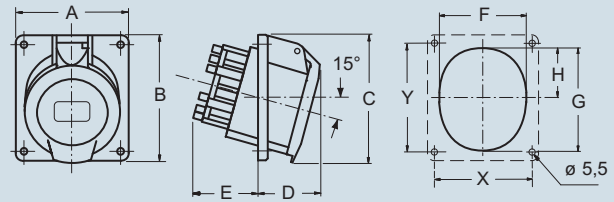

PN ... PI	A	B	C	D	E	F	G	H	X	Y
<b>16A 2P+⊕</b>	64	82	82	38	46	52	62	30	52	60
<b>3P+⊕</b>	64	82	82	42	47	57	65	28	52	60
<b>3P+N+⊕</b>	92	100	100	43	47	66	78	37.5	77	85

(16A) PN ... PQ

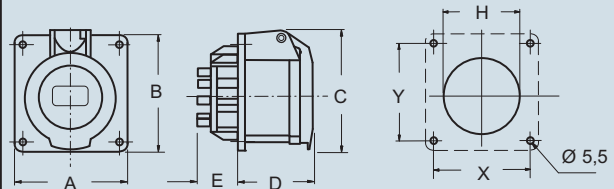

PN...PQ	A	B	C	D	E	H	X	Y
<b>16A 2P+⊕</b>	65	65	71	52	27	60	52	52
<b>3P+⊕</b>	65	65	75	53	27	61.5	52	52
<b>3P+N+⊕</b>	80	80	86	53	27	70	60	60

dimensions shown are not binding  
 and may be changed without notice



## Sales organization

---

### Headquarters

**ILME. S.p.A.**  
via Marco Antonio Colonna, 9  
20149 Milano - Italy  
T +39 02345605.22 - F +39 0233105813  
[www.ilme.com](http://www.ilme.com)

### France

**ILME FRANCE S.A.R.L.**  
Rue Roland Garros - BP 125  
Parc d'Activités de l'Aéroport  
42160 Andrézieux-Bouthéon  
T +33 (0) 4 77 36 23 36 - F +33 (0) 4 77 36 97 97  
[ilme-france@ilme.fr](mailto:ilme-france@ilme.fr)  
[www.ilme.fr](http://www.ilme.fr)

### Germany

**ILME GmbH**  
Max-Planck-Straße 12  
51674 Wiehl  
T +49 (0)2261 - 7955-0 - F +49 (0)2261 - 7955-5  
[technik@ilme.de](mailto:technik@ilme.de)  
[www.ilme.de](http://www.ilme.de)

### United Kingdom

**ILME UK LIMITED**  
50 Evans Road, Venture Point  
Speke, Merseyside L24 9PB  
T +44 (0) 151 3369321 - F +44 (0) 151 3369326  
[sales@ilmeuk.co.uk](mailto:sales@ilmeuk.co.uk)  
[www.ilmeuk.co.uk](http://www.ilmeuk.co.uk)

### Sweden and Nordic Countries

**ILME NORDIC AB**  
Transportvägen 18  
24642 Löddeköpinge  
T +46 46 18 28 00 - F +46 46 18 28 10  
[info@ilme.se](mailto:info@ilme.se)  
[www.ilme.se](http://www.ilme.se)

### Japan

**ILME JAPAN CO. LTD.**  
Kobe International Business Center - 650-0047, 5-2, 5 - Chome,  
Minatojima Minami-Machi - Chuo-Ku, Kobe  
T +81 7830 22005 - F +81 7830 22060  
[info@ilmejapan.co.jp](mailto:info@ilmejapan.co.jp)  
[www.ilme.jp](http://www.ilme.jp)

### China

**ILME CHINA CO. LTD.**  
Room 307, D area, No. 245,  
Xin Jun Huan Road, MinHang Dis  
201114 Shanghai  
T +86 21 6248 9961 - F +86 21 3478 8067  
[info@ilmechina.com](mailto:info@ilmechina.com)  
[www.ilmechina.com](http://www.ilmechina.com)

[www.ilme.com](http://www.ilme.com)

XDG LST 313



8 015747 1039567



catalogues