

APX Distribution boxes APV ATEX



The Company

INDUSTRIA LOMBARDA MATERIALE ELETTRICO SpA has been operating in Milan since 1945, in particular in the electrotechnical sector for the manufacturing of equipment for industrial installations.

ILME reflects the traditional **entrepreneurial spirit of Lombardy**, and has enjoyed continuous expansion for over half a century.

The company has carved an important role for itself in the main world markets, also operating directly in the countries that have assumed world leadership in the field of automation, including Germany and Japan.

In the **electrical connection** sector with applications in industrial automation, characterised by **top performance** and utmost **reliability needs**, ILME is today the acknowledged partner of many leading companies worldwide.

The company's fundamental values are: **product innovation**, original solutions, excellent **price-quality ratio**, a customer-oriented **sense of service**, ethical behaviour and an environmentally-friendly approach.

To promote the continuing improvement of its **qualitative results**, ILME has always encouraged its collaborators to work with utmost **responsibility and participation**.

The company focuses on a series of benefits to the user, including research into the most suitable materials, high quality and safe cabling, a rapid turnaround and readily available services.



CE marking

As from 1st January 1997, in order to make available electrical products on the European market, the manufacturer must ensure that these bear the relevant CE marking, in line with the Low Voltage Directive 73/23/EEC* (implemented in Italy as L. D. 18-10-1977 no. 791) and its modification 93/68/EEC* (implemented in Italy as L.D. 25-11-1996 no. 626/96, published in the supplement to the Gazzetta Ufficiale of 14-12-1996).

The CE marking must be visible on the product or, if this is not possible, on the packaging, the instructions for use or on the warranty certificate. It acts as a declaration by the manufacturer that the product complies with all relevant EU directives regarding its field of application.

ILME products bear the CE marking on the actual product or its packaging.

Almost all ILME products fall within the scope of the Low Voltage Directive. An EU declaration of conformity is required in order to be able to apply the CE marking. This declaration, to which the market is not directly entitled, must be made available to the controlling authorities (in Italy, the Ministry of Economic Development) at all times. In it, the manufacturer declares the technical safety standard(s) followed in the design and manufacture of the product. These standards must be, in decreasing order of preference:

- a European standard (EN prefix)
- a European harmonisation document (HD prefix)
- an international IEC standard
- a national standard
- in the absence of reference standards, the manufacturer's internal specifications guaranteeing compliance with the basic safety requirements of the directive.

Conformity with harmonised technical standards (i.e. ratified by CENELEC) also constitutes presumption of conformity with the basic safety requirements of the directives.

The CE marking of ILME products results from the declaration of conformity of the product to harmonised standards or international IEC standards.

Through the CE marking, ILME declares full compliance, not merely with the directive's basic safety requirements, but also with those international or national standards on which voluntary safety certification markings are based (e.g. IMQ and VDE). In this way, ILME intends to give the CE marking the value of self-certification in terms of safety, given the loss in legal value of voluntary certifications issued by third parties, ratified by directive 93/68/EEC*.

Notwithstanding the above, practically all ILME products still bear voluntary conformity markings.

The above mentioned EU declaration of conformity becomes null and void when the assembly of products includes one or more components not manufactured by ILME and without CE marking.

* **Note:** The next legal reference for the Low Voltage Directive was 2006/95/EC, as consolidation of the original Directive 73/23/EEC + Directive 93/68/EEC. On 29th March 2014, the Official Journal of the European Union published the new Low Voltage directive 2014/35/EU dd. 26th February 2014, a recast version of directive 2006/95/EC, which is in force since 20th April 2016.

All information contained in this catalogue is not binding and may be changed without notice.



UNI EN ISO 9001: 2015
Design, manufacture and distribution
of industrial electrical equipment (IAF 19)
Certificate No. 50 100 11133

APX ATEX distribution boxes

ILME has a long history of manufacturing die-cast aluminium alloy distribution boxes to meet the protection requirements of industrial environments.

AP series distribution boxes are also available in the **APX version**. APX distribution boxes are **Ex components** and therefore suitable for fixed installations in explosive atmospheres due to the presence of **gases** and/or **dust**, classified as **Zone 2** (gases) and/or **Zone 22** (dust) in ATEX Directive 2014/34/EU.

The range covers the 7 sizes that are now available in the ATEX version (APX) painted in RAL 7040 grey (like APV standard models).

The gasket, in EPDM for sizes 9, 11, 12, 14 and 19 and in silicone rubber foam for sizes 20 and 21, is fitted in the perimetral slot on the cover and is specifically designed to guarantee the IP66/IP67 degree of protection required for Ex protection types, even in presence of the maximum temperatures applicable to the marking.

APX boxes are supplied with an **external protective earthing and bonding terminal** complete with an M4 self-forming galvanized steel screw, a flat washer and a crimp ring lug in tinned copper for protection leads with a cross-sectional area up to 6 mm² in order to guarantee the external equipotential bonding indicated in ATEX standards.

All boxes are also supplied with an **instruction sheet** to provide installation, operation and maintenance information and with the **Attestation of Conformity for EX Components** in compliance with ATEX Directive 2014/34/EU and the EU Declaration of Conformity to the Low Voltage Directive 2014/35/EU.

The inside of the boxes contains supports for protective earthing and for the application of the bottom plates. All boxes have closed walls. The instruction sheet supplied with each product shows the points that can be drilled on each side (the cover must never be drilled).

The IP degree of protection marked on the product is guaranteed only if each opening is coupled with an entry device with an equivalent or higher IP degree of protection, which must be chosen in compliance with the requirements of the ATEX Directive and which must have a classification suitable for at least zones 2 and 22.

Classification

In accordance with ATEX Directive 2014/34/EU, APX boxes conform with the following standards: **EN IEC 60079-0:2018 + EN IEC 60079-0/AC:2020**, **EN 60079-15:2010** (gases, protection type "n"), and **EN 60079-31:2014** (combustive dust, protection type with "t" enclosures).

Boxes are also compliant with the Low Voltage Directive 2014/35/EU because they have been manufactured in accordance with **EN IEC 60670-1:2021 + EN IEC 60670-1/A11:2021** and **EN 60670-22:2006** (classification CEI 23-94) and - as far as applicable - to the current standard EN 60670-24:2013.

Classification:

Identification marking used for protection types:

Protection degree in accordance with EN 60529:

Max permitted surface temperature (dust):

Temperature class (Group II equipment, gases):

Electrical properties:

Group II components – Category 3 GD

Ex II 3 GD

Ex nA IIC T6 Gc UX

Ex tc IIIC -20 °C ≤ Ta ≤ 85 °C Dc IP66/IP67 UX

IP66/IP67

85 °C

T6

Guaranteed electrical continuity

Fields of application

Fixed installation in areas exposed to a potential risk of explosion, classified as Zone 2 (gases) and/or Zone 22 (dust).

NOTE

The classification of areas should respectively comply with the following standards:

- Standard EN 60079-10-1:2015 for gases

- Standard EN 60079-10-2:2015 for dust

The boxes have a very high resistance to weathering agents and are suitable to be installed outdoors.



Product features

Distribution boxes made of EN AB 46100 aluminium alloy (previously UNI 5076) in accordance with standards UNI EN 1676 and oven painted with RAL 7040 epoxy-polyester resins

Supplied with:

- Cover with pre-fastened gasket
- Galvanized steel screws to fix the cover in place
- O-ring in nitrile rubber to hold the cover screws in place (captive screws)
- 2 internal equipotential bonding kits (between the box and the cover), each consisting of: 1 M4x8 threaded brass insert, 1 M4x8 zinc-plated steel screw, 1 ring lug in tinned copper for a cross-sectional area up to 6 mm²
- 1 external equipotential bonding kit (1 M4x8 mm galvanized steel self-forming screw + 1 lug in tinned copper for a cross-sectional area up to 6 mm²)
- Installation, operation and maintenance instructions, **Attestation of Conformity for EX Components** in compliance with ATEX Directive 2014/34/EU and the EU Declaration of Conformity to the Low Voltage Directive 2014/35/EU

The inside of the boxes contains supports for protective earthing and bonding and for the application of the bottom plates, supports and other accessories. The hole on the outside can be used for the equipotential bonding connection.

Wall-mounting is possible thanks to the external brackets built into the base.

Every box is packaged individually.

Kits for internal fixings (bottom plates, DIN EN 60715 rails) are available on request (see the applicable catalogue page).

ATTENTION!

APX distribution boxes are sold empty. According to the ATEX Directive, they are regarded as electric material therefore classified as **Ex components**. They can be used in combination with other electrical equipment in which case the **end user must obtain a further ATEX certification** in addition to the one supplied by ILME S.p.A.

In addition to the markings required to certify compliance with product standards CEI EN 60670-1 and CEI EN 60670-22 (IP66/IP67 protection degree, trademark) and with the **CE marking that confirms compliance with the Low Voltage Directive 2014/35/EU**, each box has a nameplate on the cover that lists the markings required by the latest editions of applicable ATEX standards (CEI EN 60079-0, CEI EN 60079-15 and CEI EN 60079-31) that integrate those required by the ATEX Directive.

NOTE – The new edition of standard CEI EN 60079-0 groups all ATEX safety requirements concerning both gases and dust. Marking requirements have been further changed, so for a certain period of time different markings that are substantially equivalent may be found simultaneously on the market.

Example of marking and description of the symbols used on the nameplate

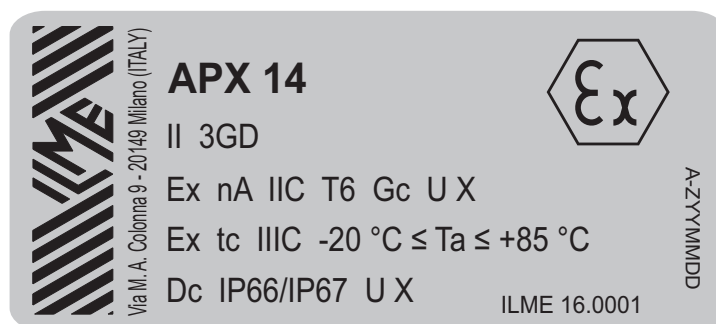

Symbol	Meaning
	Manufacturer's logo (ILME S.p.A.)
Via M. A. Colonna 9 20149 Milano (ITALY)	Manufacturer's address (mandatory for ATEX Directive 2014/34/EU)
	CE marking (that indicates conformity with the Low Voltage Directive 2014/35/EU) NOTE -as an Ex component, no CE marking is required by the ATEX Directive 2014/34/EU, nor by the RoHS 2 Directive 2011/65/EU + 2015/863/EU
APX 14	Type reference of product (product code)
	Ex symbol that indicates the specific marking related to the protection against the risk of explosion referred to in ATEX Directive 2014/34/EU
II	Group, indicates the type of intended use for which the product is suitable: Group II = Surface industries (Group I = Mining sites)
3GD	Category that identifies the equipment protection level: Category 3 = Ordinary risk of explosion (for Zones 2 and 22) G = Protection from gases D = Protection from dust
Ex nA	Ex protection mode for protection from gases: product designed to be used with non-sparking equipment "nA" (that does not produce electric arcs or sparks)
IIC	Group II of electrical equipment designed for explosive atmospheres, for type C gases (typically hydrogen)
T6	Temperature class (85 °C)
Gc	Protection level assigned for explosive atmospheres containing gases (G = Gas). EPL Gc Equipment protection level (EPL) equivalent to c ("increased")
U	Symbol that confirms that the product is classified as an Ex component (gases)
X	Symbol indicating that the Ex product must follow special instructions (those provided in this manual)
Ex tc	Protection type <u>against explosive dust</u> with enclosure "t", for protection level "tc" (= Equipment protection level EPL = "Dc", see below)
IIIC	Group III of electrical equipment designed for explosive atmospheres containing dust other than mining sites, for conductive dust
-20 °C ≤ Ta ≤ 85 °C	Assigned ambient temperature range
Dc	Protection level assigned for explosive atmospheres containing dust (D = Dust). EPL Dc Equipment protection level (EPL) equivalent to c ("increased")
IP66/IP67	IP protection degree against the penetration of dust (first characteristic digit) and liquids (second characteristic digit) in accordance with EN 60529: IP66 = Dust-tight and protected against powerful water jets IP67 = Dust-tight and protected against temporary immersion in water
U	Symbol that confirms that the product is classified as an Ex component (dust)
X	Symbol indicating that the Ex product must follow special instructions (those provided in this manual)
A-ZYYMMDD	Traceability code that identifies the production lot (A = Product revision, Z = Code for internal use, YYMMDD = Production date (YY = Year, MM = Month, DD = Day))
ILME 16.0001	Name of the subject that has issued the certificate of conformity to the applicable ATEX standards: self-certified ATEX component (ILME); 16 = Last two digits of the year in which the certificate has been issued; 0001 = Progressive number of the certificate issued in the specific year



Via M. A. Colonna 9 - 20149 Milano (ITALY)

APX 9

II 3GD



Ex nA IIC T6 Gc U X

Ex tc IIIC -20 °C ≤ Ta ≤ +85 °C

Dc IP66/IP67 U X

ILME 16.0001

A-ZYYMMDD

Via M. A. Colonna 9 - 20149 Milano (ITALY)

APX 11

II 3GD



Ex nA IIC T6 Gc U X

Ex tc IIIC -20 °C ≤ Ta ≤ +85 °C

Dc IP66/IP67 U X

ILME 16.0001

A-ZYYMMDD

Via M. A. Colonna 9 - 20149 Milano (ITALY)

APX 12

II 3GD



Ex nA IIC T6 Gc U X

Ex tc IIIC -20 °C ≤ Ta ≤ +85 °C

Dc IP66/IP67 U X

ILME 16.0001

A-ZYYMMDD

Via M. A. Colonna 9 - 20149 Milano (ITALY)

APX 14

II 3GD



Ex nA IIC T6 Gc U X

Ex tc IIIC -20 °C ≤ Ta ≤ +85 °C

Dc IP66/IP67 U X

ILME 16.0001

A-ZYYMMDD

Via M. A. Colonna 9 - 20149 Milano (ITALY)

APX 19

II 3GD



Ex nA IIC T6 Gc U X

Ex tc IIIC -20 °C ≤ Ta ≤ +85 °C

Dc IP66/IP67 U X

ILME 16.0001

A-ZYYMMDD

Via M. A. Colonna 9 - 20149 Milano (ITALY)

APX 20

II 3GD



Ex nA IIC T6 Gc U X

Ex tc IIIC -20 °C ≤ Ta ≤ +85 °C

Dc IP66/IP67 U X

ILME 16.0001

A-ZYYMMDD

Via M. A. Colonna 9 - 20149 Milano (ITALY)

APX 21

II 3GD

Ex nA IIC T6 Gc U X

Ex tc IIIC -20 °C ≤ Ta ≤ +85 °C

Dc IP66/IP67 U X

ILME 16.0001

A-ZYYMMDD



Background information on ATEX

The name ATEX, although unofficial, is today universally used to refer to European Directives **2014/34/EU** and **1999/92/EC**. This acronym derives from the French term **AT**mosphère **EX**plosible.

- **Directive 94/9/EC** later replaced by the currently edition in force **2014/34/EU**, is also known as the "Directive on ATEX products" or also called by insiders "**ATEX 95**" or alternatively "**ATEX 100a**", based on the articles of the Treaty that established the creation of the European Community (now European Union), which specifies that the Council may adopt, by means of directives, measures to support and regulate the internal market. This directive has been in force since 1-07-2003.

- **Directive 99/92/EC** is also known as the "social ATEX directive" or the "ATEX directive concerning workplaces" or referred to by insiders as "**ATEX 137**", based on the article of the Treaty that established the creation of the European Community, which specifies that the Council may adopt, by means of directives, minimum measures in order to promote the improvement of workplaces in particular so as to guarantee a higher level of safety and the health of workers. This directive has been in force since 1-07-2006.

The two ATEX directives define the safety rules that have to be implemented in workplaces exposed to the risks of explosion due to the presence of combusive gases/vapours/mists. They have been acknowledged by the EU member states and converted into national laws and/or decrees, with provisions concerning the various levels of **responsibilities**.

Responsibilities

Manufacturer of electrical equipment

Equipment designed to be used in explosive atmospheres must be designed and manufactured so that it does not generate ignition sources. In Europe, electrical equipment designed to be installed in explosive atmospheres falls within the scope of Directive 2014/34/EU (ATEX) and can be sold in Europe only if it complies with this directive. The manufacturer must classify the equipment according to the safety levels guaranteed by the design principles used during manufacturing in order to allow end users to select the equipment that best suits the area of installation.

Based on the declared category, the manufacturer must verify that the equipment complies with the "main safety requirements" (*EHSR Essential Health and Safety Requirements*) of the directive, prepare the technical file, define the safety instructions and apply the CE marking in compliance with Directive 2014/34/EU.

Products must be introduced in the market with the correct marking, and supplied with the necessary safety instructions and the EC declaration of conformity.

Employer

According to the provisions of Directive 99/92/EC, the employer must assess the risks to which workers may be exposed in explosive atmospheres.

In particular, the directive establishes that the employer must:

- Divide the working areas into zones (Zone 0, 1, 2, 20, 21, 22)
- Implement the minimum safety requirements (the main safety requirements indicated in the directive) in hazardous areas
- Implement organisational provisions and protective measures against explosions (including reference information on the choice of electric and non electrical equipment, as per Directive 2014/34/EU)
- Inspect the electric equipment installed in Zones 0, 1, 20, and 21 every 2 years, in accordance with Italy Presidential Decree 462/2001 (*)

The employer must also choose the correct type of electrical equipment on the basis of the type of hazardous area and prepare a document with information on the protection against explosions.

(*) Note: The legislation reported here is valid in Italy. Similar legislation is in force in different countries.

Designer

A project is always required for electrical equipment in zones at risk of explosion. The electrical installation designer, who must have specific experience in the design of electrical equipment and must be a regular member of a professional register, prepares the project on the employer's request.

The designer must design the electrical installation in accordance with the best working practices, that is in compliance with all applicable European harmonised standards. For electrical installations designed to be installed in explosive atmospheres, the best working practices are represented by the installation standards in force at the time of design phase. It is important to remember that the classification of working areas into zones (Zone 0, 1, 2, 20, 21 and 22) must be supplied by the employer, who is responsible by law for the same.

Installer

The installer must install the electrical plants in compliance with design technical specifications and the best working practices (installation standards in force at the time of installation), and observe the safety instructions provided by the manufacturer for equipment compliant with ATEX Directive 2014/34/EU. Failure to follow these instructions may compromise the protection type of the equipment, resulting in the invalidity of conformity with the directive, without any responsibility on the manufacturer's side. At the end of the work, the installer must issue a declaration of conformity according the law requirements applicable in the country of installation (in Italy the reference law is Ministerial Decree 37/08).

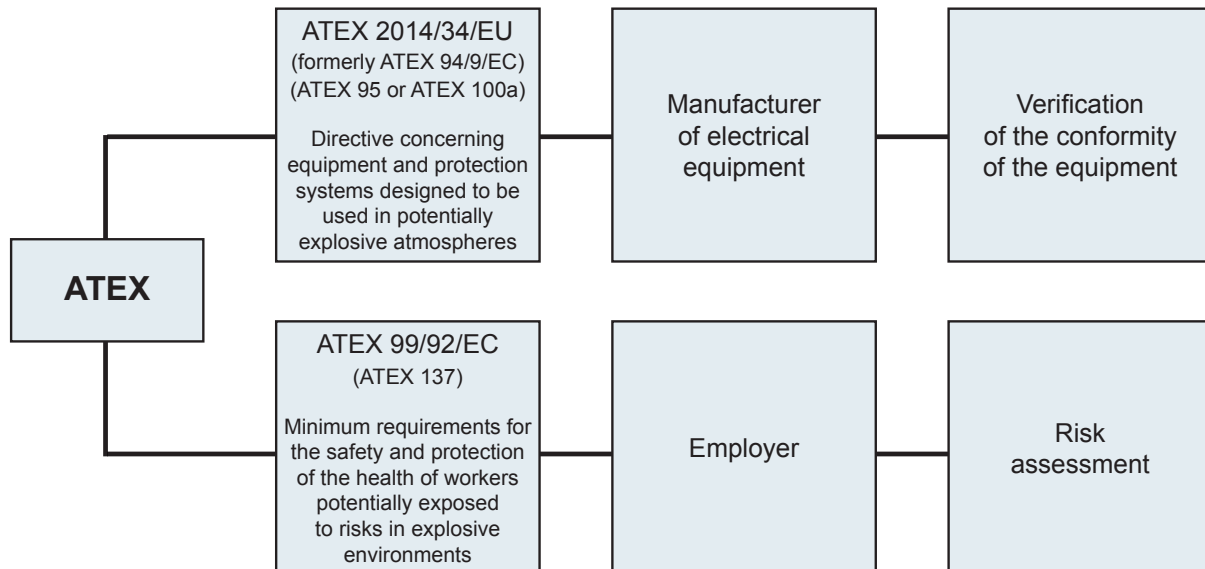

Declaration of conformity - Warnings

Every product that complies with Directive 2014/34/EU must be supplied with either an EU declaration of conformity if end product (not the case of APX distribution boxes) or with an Attestation of Conformity for Ex components (APX) that must contain at least the following information:

- Name or trademark and address of the manufacturer
- Description of the equipment
- Provisions to which the equipment complies
- Name, identification number and address of the notified body
- "EU Type" certificate number (for EU declaration of conformity)
- Identification data of the signee binding the manufacturer or the EU representative
- Reference to (if applicable): harmonised standards, technical specifications used and other EU directives applied (for EU declaration of conformity)

If the conformity procedures stated in the directive do not require the participation of a notified body (Group II, category 3 equipment), in the EC declaration of conformity there will be no reference to a notified body or to the "EC type" certificate.

Instructions for use are very important because their correct application is a necessary condition to ensure the observance of the essential health and safety requirements (EHSR).

Therefore, the instructions for use must detail the operations that must be carried for a safe execution of the following: correct use (zone, environmental conditions, reference to safety signs, etc.); correct operation (forbidden, specific or limited conditions of use, if applicable); correct installation and/or adjustment; commissioning; correct maintenance; installation and/or replacement of components.

Classification of potentially explosive areas in accordance with standards EN 60079-10-1 and EN 60079-10-2

Classification of areas		Description
Gas	Dust	
ZONE 0	ZONE 20	Area in which the explosive atmosphere is permanent, present for long periods of time or frequent
ZONE 1	ZONE 21	Area in which the explosive atmosphere is occasionally present during the ordinary use of equipment
ZONE 2	ZONE 22	Area in which the explosive atmosphere is unlikely to form during the ordinary use of equipment and, if present, persist for a short period of time only

Zones 2 and 22 are defined as follows in Directive 99/92/EC:

Zone 2 - Area in which during ordinary activities an explosive atmosphere consisting in a mixture of air and flammable substances in the form of gas, vapour or mist, is unlikely to form and, when this does, it is for a short period of time only.

Zone 22 - Area in which during ordinary activities an explosive atmosphere consisting in a cloud of combustible dust is unlikely to form and, when it does, it is for a short period of time only.

Zones, groups and product categories are divided as follows:

Flammable material	Zone (Directive 99/92/EC)	Group (Directive 99/92/EC)	Category (Directive 99/92/EC)
Methane, dust	Mining industry	I	M1
	Mining industry	I	M2 or M1
Gases, vapours	Zone 0: permanent, long-term or frequent explosive atmosphere	II	1G
	Zone 1: occasionally explosive atmosphere	II	2G or 1G
	Zone 2: explosive atmosphere that is unlikely to form or that persists for short periods of time	II	3G or 2G or 1G
Dust	Zone 20: permanent, long-term or frequent explosive atmosphere	II	1D
	Zone 21: occasionally explosive atmosphere	II	2D or 1D
	Zone 22: explosive atmosphere that is unlikely to form or that persists for short periods of time	II	3D or 2D or 1D

In Zones 0, 1, 20 and 21 only electrical equipment with an EX certification issued by third parties can be used. In Zone 0, it is however only possible to use equipment that has been specifically approved for use in this zone.

In Zones 2 and 22, it is possible to use electrical equipments that comply with the main safety requirements of ATEX Directive 2014/34/EU and for which the manufacturer has issued a certificate of conformity.

For more detailed information, refer to the integral text of the two directives and to the Implementation Guidelines of the directives available on the European Union website, in addition to the law provisions in force in the member states, which may differ in terms of applicable sanctions.

For technical information concerning the design and manufacture of equipment, refer to the harmonised standard in force, which is continuously being amended and updated. The following section provides general information on the classification of ATEX areas where combustible dust is present.

Classification of ATEX areas where combustible dust is present

The classification of these areas is based on the same approach used for explosive atmospheres where gases are present. However, the assessment of these areas is more direct because of the relatively consistent behaviour of the different types of dust, which is less varied as compared to the behaviour of flammable gases, vapours and mists.

An explosion of dust produces a rapid combustion, which releases energy in the form of heat and overpressure.

The conditions that may lead to the formation of a potentially explosive atmosphere can be summarised as follows:

- Dust must be combustible
- Dust must be dispersed in air
- The granulometry of dust must permit the propagation of flames
- The concentration of dust must fall within the so-called flammability limit
- An ignition source with sufficient energy must be present
- A sufficient amount of combustible agent (oxygen) must be present to enable combustion

To determine if these conditions may occur, it is necessary to follow the procedure described below.

Analysis of emissions

- Assessment of the substances used and identification of combustible dusts
- Acquisition of all data on the chemical-physical properties of the combustible dusts involved and as required for assessment purposes
- Identification of the emission sources, intended as points or parts of a processing plant from which combustible dust may leak causing the formation of a potentially explosive atmosphere
Note: a layer of dust may represent a source of emission because it could cause the dispersion of a cloud in the presence of air flows. The dust may also act as ignition source in existing explosive atmospheres.
- Assessment of the emission degree for each emission source

As for gases, the emission degrees of dust can be classified as follows:

- Continuous: if the emission is continuous or can occur for long periods of time during the ordinary use of processing equipment (inside storage equipment, silos, hoppers)
- First: if the emission can occur periodically or occasionally during the ordinary use of the processing equipment (samplings, areas where loading and discharge operations are carried out)
- Second: if the emission is unlikely to occur during the ordinary use of processing equipment, but can occur occasionally and only for short periods of time, for example due to a fault (flanges, bag discharge units)

Classification of areas

The current reference standard for the classification of areas where dangers may occur in presence of flammable gases, vapours or mists is **EN 60079-10-1**. The probability of the formation of an explosive atmosphere due to the presence of gases, that is the classification of the type of zone, is essentially related to the emission degree and ventilation. Zones are classified as Zone 0, Zone 1, Zone 2 and safe areas.

Zones can be defined as follows:

- **Zone 0** Area around a continuous degree emission
- **Zone 1** Area around a first degree emission
- **Zone 2** Area around a second degree emission

For combustive dust, there is a rather direct transition between the degree of the emission source and the type of dangerous zone that forms:

- **Zone 20** Area around continuous degree emissions
- **Zone 21** Area around first degree emissions
- **Zone 22** Area around second degree emissions

The presence of a suction system is extremely important to maintain the areas clean. If the suction system is adequate and guaranteed, it is possible to reduce the classification of zones because this type of equipment prevents the formation of layers, thus reducing the emission sources and the extent of the dangerous area.

After determining the type of dangerous zone, it is necessary to determine its extension in accordance with the requirements of the standard. At present the reference standard is **EN 60079-10-2**.

Table 1 – Categories of ATEX products and application zone

Category	Protection level	Presence and duration of the explosive atmosphere	ZONE (gases)	ZONE (dust)
1	- Very high - Two protection barriers - Safety guaranteed even with two faults	- Permanent, frequent or for long periods of time during the ordinary use of equipment	Zone 0	Zone 20
2	- High - One protection barrier - Safety guaranteed even with one fault	- Occasionally, probable during the ordinary use of equipment	Zone 1	Zone 21
3	- Normal - Safety guaranteed during the use of the equipment normal	- Unlikely during the ordinary use of the equipment - For short periods only	Zone 2	Zone 22

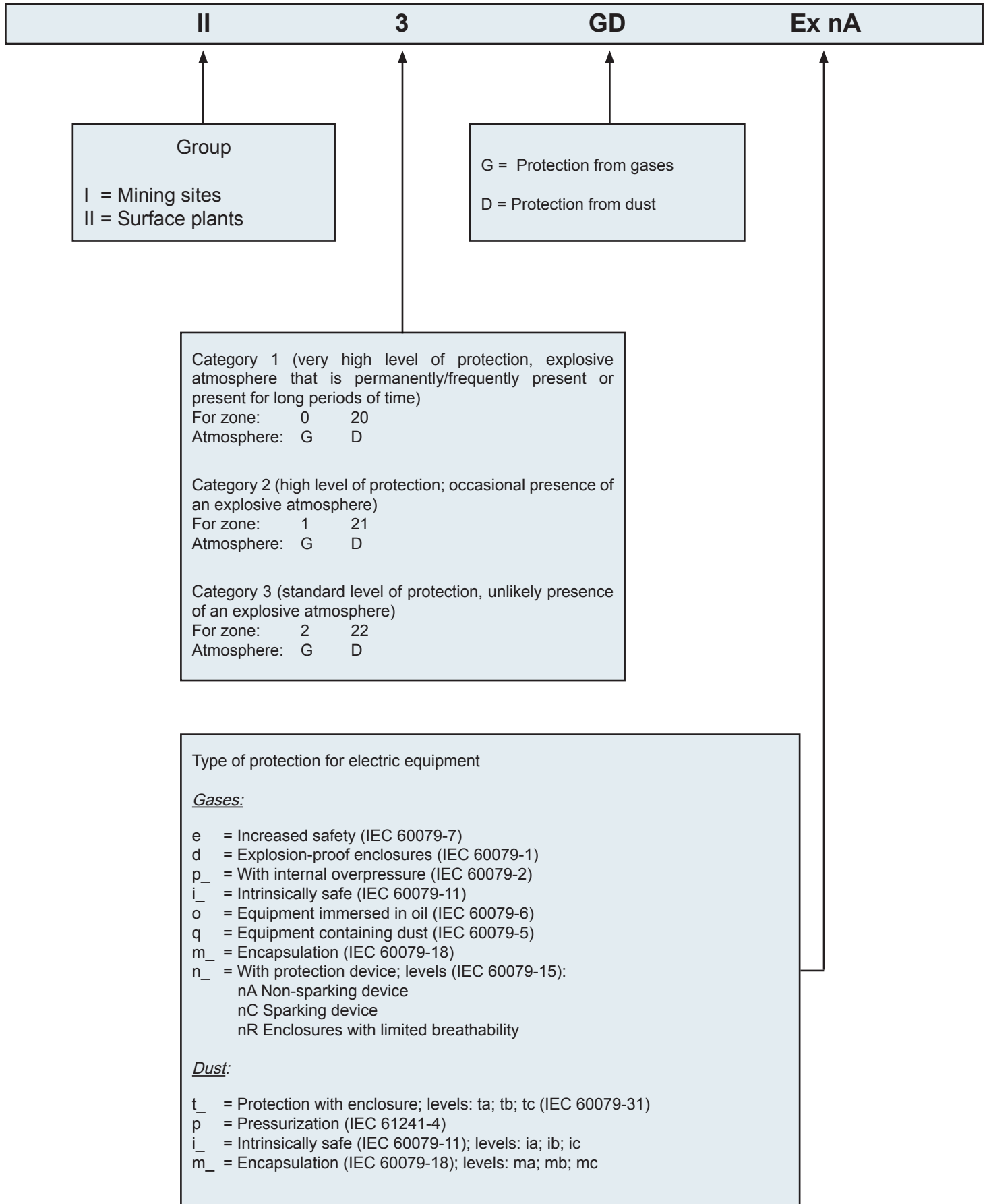

Example of equipment classification:

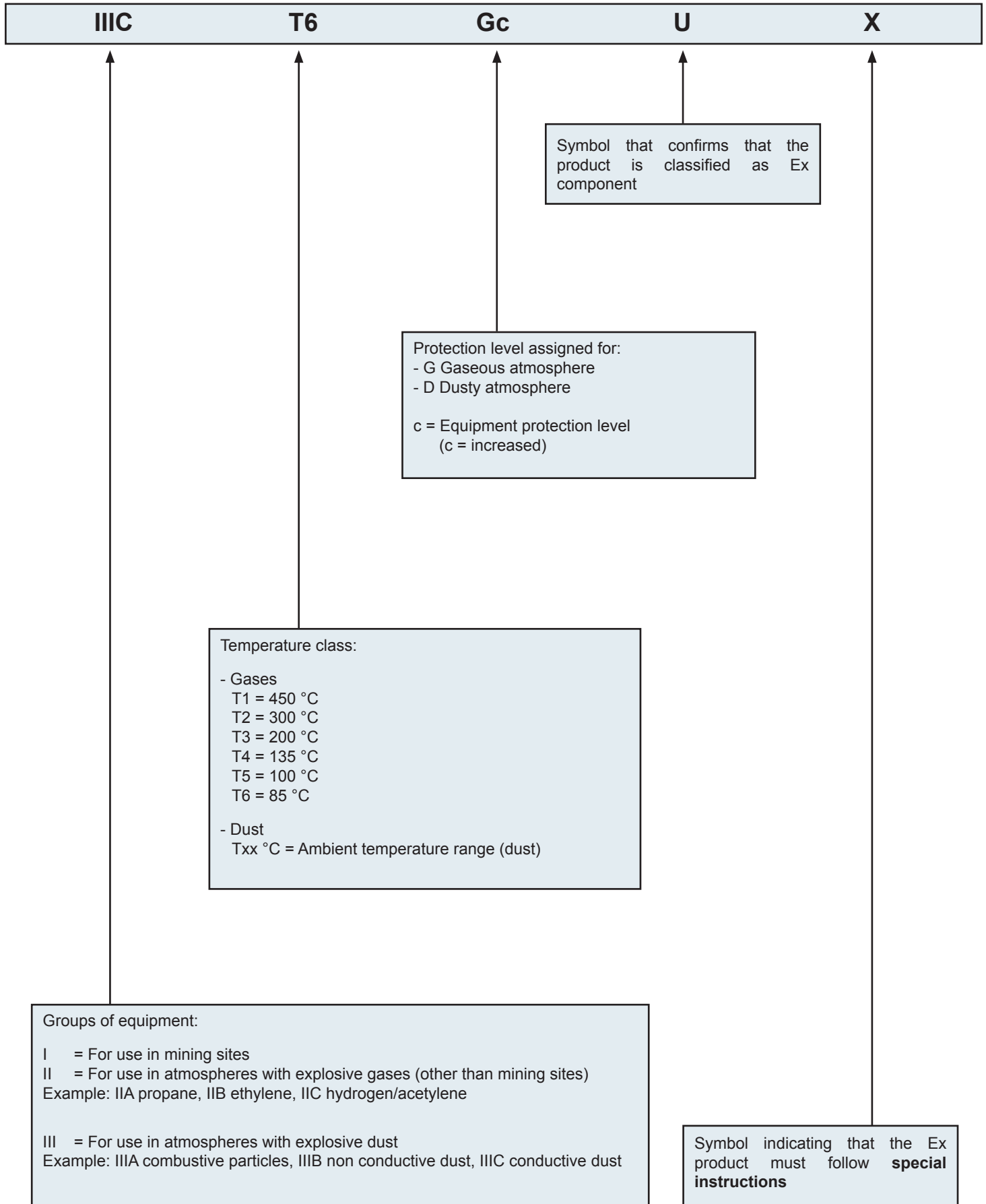

APX ATEX distribution boxes with cover



- Usable with non-sparking parts
- Boxes and covers in die-cast aluminium alloy
- Galvanized steel screws for fixing cover
- Pre-applied anti-ageing gaskets
- IP66/IP67 degree of protection (compliant with EN 60529)
- Temperature range: -20 °C ÷ +85 °C
- Oven painted with RAL 7040 grey epoxy-polyester powder
- For information on the accessories for boxes, refer to page 11
- Supplied with 2 brass inserts, 2 screws, 2 lugs and 2 washers for 6 mm² earth terminals
- Supplied with M4 galvanized steel self-forming screw, lug and washer for 6 mm² external earth terminals
- The cover must always be grounded
- O-rings to make the cover screws captive, included

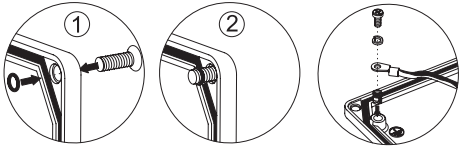

description
External dimensions 100 x 100 x 59
External dimensions 115 x 140 x 61
External dimensions 141 x 166 x 64
External dimensions 168 x 192 x 80
External dimensions 217 x 253 x 93
External dimensions 264 x 314 x 122
External dimensions 315 x 410 x 150

Fixing centre distance in mm, **APX 9**

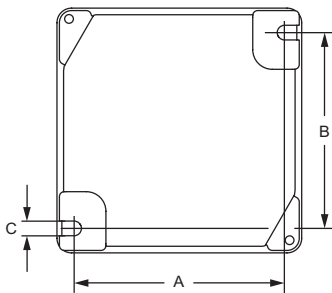

Fixing centre line in mm, **APX 11/12/14/19/20/21**

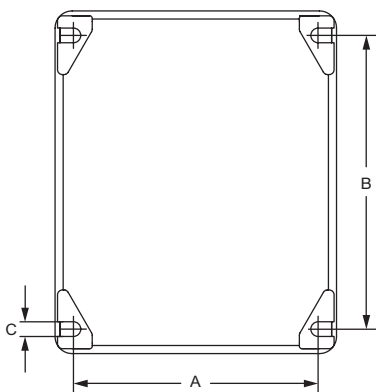

part No.	A	B	C
APX 9	90	80	6
APX 11	105	120	6
APX 12	125	144	6.5
APX 14	149	168	6.5
APX 19	196	226	9
APX 20	236	275	9
APX 21	283	367	9

We reserve the right to change the technical information, drawings and products referenced in this document. Dimensions are indicative only and may be changed without notice.

APX painted distribution boxes



part No.
APX 9

dimensions in mm

APX 9

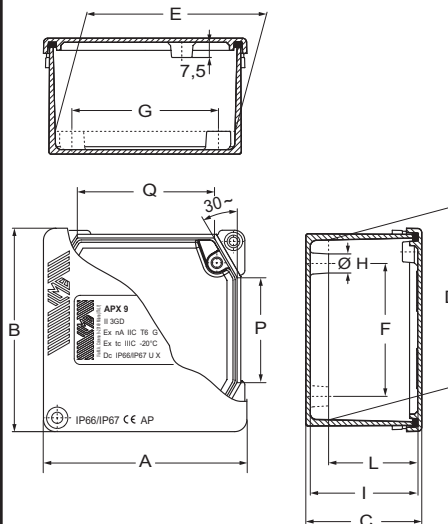

APX painted distribution boxes



part No.
APX 11
APX 12
APX 14
APX 19
APX 20
APX 21

dimensions in mm

APX 11/12/14/19/20/21

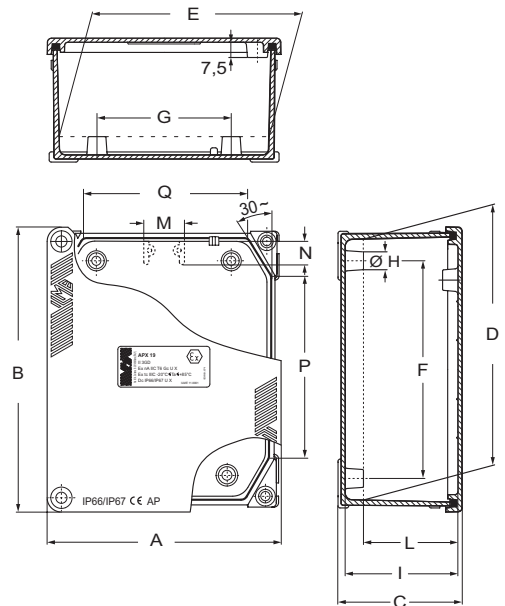

part No.	A	B	C	D(*)	E(*)	F	G	øH	I	L	M	N	P	Q
APX 9	100	100	59	88	88	66	70.5	10	53	44	-	-	48	65
APX 11	115	140	61	128	103	107	66	10	55	46	-	-	90	81
APX 12	141	166	64	153	128	121	99	12.5	58	49	-	-	104	100
APX 14	168	192	80	176	152	153	113	10	74	65	-	-	128	125
APX 19	217	253	93	236	201	188	153	12.5	85	75	38	21	169	162
APX 20	264	314	122	292	243	238	198	12.5	114	104	49	24	203	192
APX 21	315	410	150	386	291	333	248	12.5	141	126	61	31	295	240

(*) Minimal internal dimensions measured on the plane of the supporting bars for the bottom plate

ATTENTION!

APX distribution boxes are sold empty. According to Directive ATEX, they are regarded electric material and therefore classified as **Ex components**.

They can be used in combination with other electrical equipment in which case **the user must obtain a further ATEX certification** in addition to the one supplied by ILME S.p.A.

- Usable with non-sparking parts

Zinc-plated steel mounting plates



DIN rail M4x8 brass insert Fastening wire on box

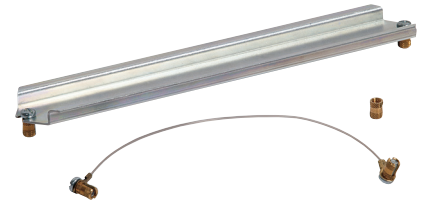

description

part No.

part No.

Mounting plates with two earth terminals, inserts and fixing screws on the bottom of the box

- For APX 11 boxes
- For APX 12 boxes
- For APX 14 boxes
- For APX 19 boxes
- For APX 20 boxes
- For APX 21 boxes

- APF 11**
- APF 12**
- APF 14**
- APF 19**
- APF 20**
- APF 21**

DIN rail with fixing screws and inserts

- For APX 9 boxes
- For APX 11 boxes
- For APX 12 boxes
- For APX 14 boxes
- For APX 19 boxes
- For APX 20 boxes
- For APX 21 boxes

- APD 9**
- APD 11**
- APD 12**
- APD 14**
- APD 19**
- APD 20**
- APD 21**

- M4x8 thread brass insert to simplify the fitting of equipment and PCBs on the bottom of the box
- Cover fastening wire to anchor the cover to the box (temperature range: -40 °C ÷ +110 °C)

APR 04

APR F

dimensions in mm

dimensions in mm

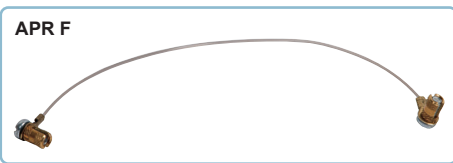
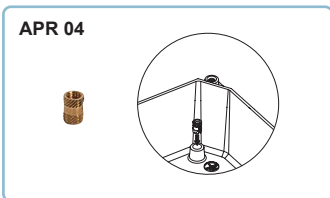

APF

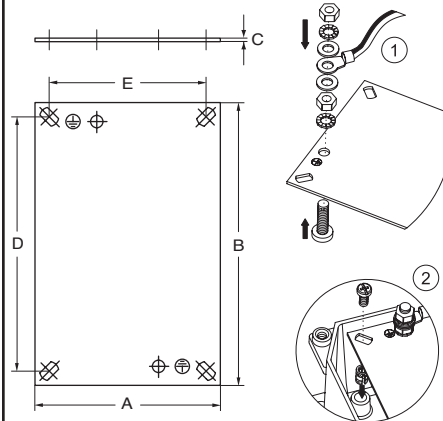

APD

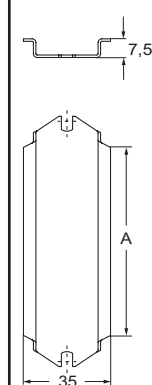

part No.	A	B	C	D	E
APF 11	78	119	1.5	107	66
APF 12	111	133	1.5	121	99
APF 14	125	165	1.5	153	113
APF 19	165	200	1.5	188	153
APF 20	210	250	1.5	238	198
APF 21	260	345	1.5	333	248

part No.	A
APD 9	74
APD 11	103
APD 12	134
APF 19	165
APF 20	210
APF 21	260
APD 21	393

We reserve the right to change the technical information, drawings and products referenced in this document. Dimensions are indicative only and may be changed without notice.



APX series DISTRIBUTION BOXES

Installation, operation and maintenance instructions

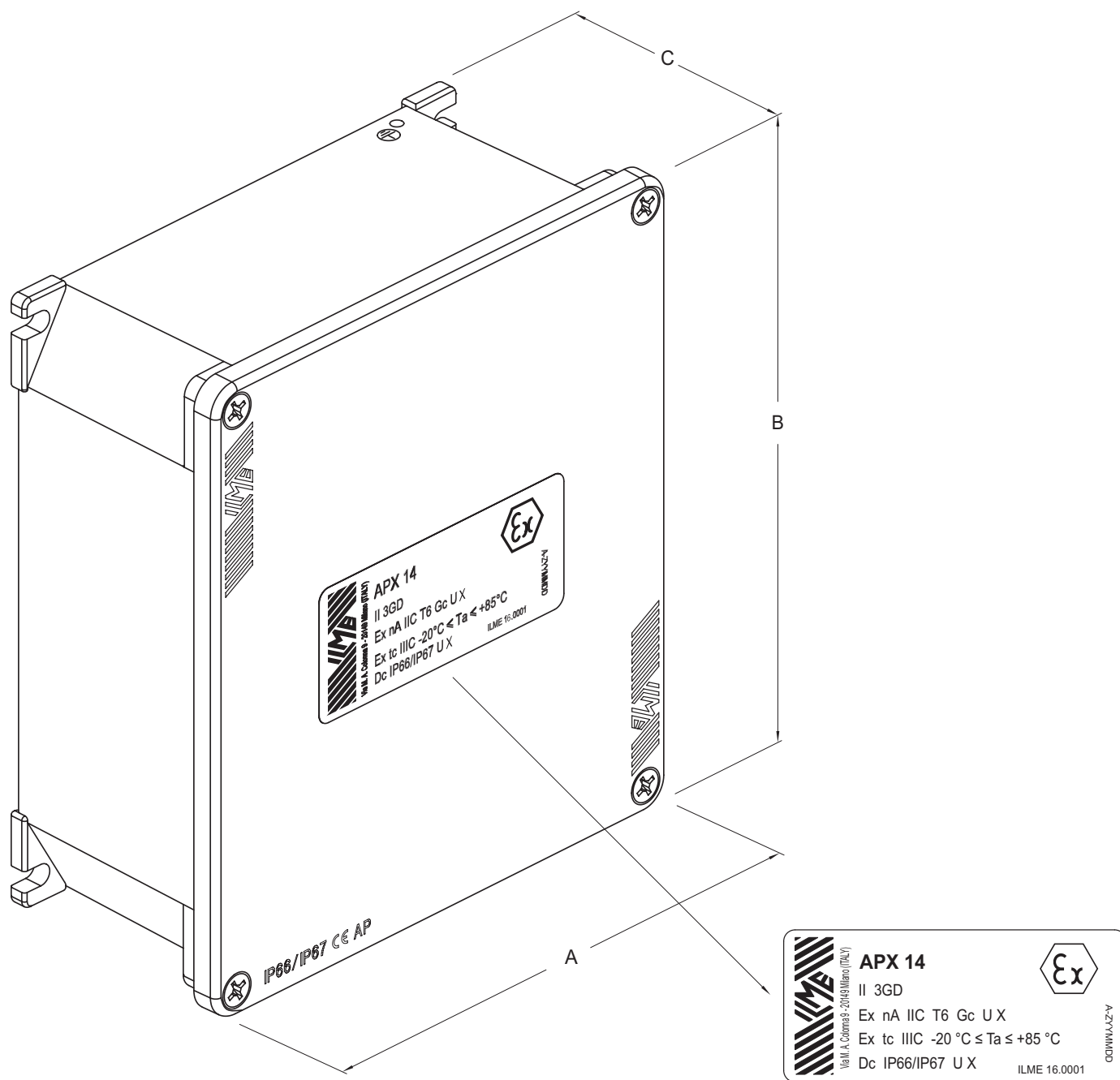

Figure 1 - Perspective view showing the details of a sample nameplate

TABLE 1

Code	A	B	C	Cover fixing screws	Screw driver slot	Tightening torque [Nm]
APX 9	100	100	59	2x M5x16	Ph2	2.0
APX 11	115	140	61	4x M5x16	Ph2	2.0
APX 12	141	166	64	4x M5x16	Ph2	2.0
APX 14	168	192	80	4x M5x16	Ph2	2.0
APX 19	217	253	93	4x M6x20	Ph2	2.5
APX 20	264	314	122	4x M6x20	Ph2	2.5
APX 21	315	410	150	4x M6x20	Ph2	2.5

Ex classification of products



II 3 GD

Ex nA IIC T6 Gc U X

Ex tc IIIC $-20\text{ °C} \leq T_a \leq 85\text{ °C}$ Dc IP66/IP67 U X

For a description of all the symbols present on the nameplate, refer to **ATTACHMENT 1** in this document.

Technical data

<i>Ex protection type</i>	Ex nA IIC T6 Gc U X Ex tc IIIC $-20\text{ °C} \leq T_a \leq 85\text{ °C}$ Dc IP66/IP67 U X
<i>Protection degree (IP code)</i>	IP66/IP67
<i>Protection degree against mechanical impacts (IK code)</i>	IK08
<i>Enclosure material</i>	Die-cast aluminium. Oven painted with epoxy-polyester resins; suitable for outdoor applications
<i>Gasket material</i>	Thermosetting elastomer
<i>Ambient temperature range (T_a)</i>	$-20\text{ °C} \dots +85\text{ °C}$
<i>Max permitted surface temperature</i>	+85 °C

GENERAL WARNINGS

ATTENTION!



APX distribution boxes are supplied as empty enclosures. They are classified as electrical equipment according to the Low Voltage Directive (LVD) 2014/35/EU, but as **Ex components** (symbol **U** on the nameplate) according to the ATEX Directive 2014/34/EU, and also as **electrical components** according to the RoHS Directive 2011/65/EU + 2015/863/EU.

Thus, the **CE** marking covers only the conformity to the LVD.

Based on the assigned Ex protection modes, they can be used only in combination with **non-sparking equipment**, for example with suitable terminal blocks. **The resulting assembly requires a further ATEX certification, by the manufacturer of the assembly, in addition to the Attestation of Conformity issued by ILME S.p.A. if nonsparking equipment (like junction terminal blocks) is installed inside the box.**



APX distribution boxes are only suitable for installation in areas classified as **Zone 2** (gases) and/or **Zone 22** (dust) in accordance with standard CEI EN 60079-0:2012-08. Use these boxes for approved applications only, within their ordinary operating limits, and always maintain them clean and in good working order.

The customer/plant designer is responsible for **classifying the areas** where potentially explosive atmospheres are present in order to select the most suitable product.



Always observe design standards, choose and install electrical equipment suitable for explosive atmospheres (EN 60079-14:2014-03), and follow national accident prevention regulations and the safety instructions contained in this manual when performing any work on the enclosure.

Products must be installed according to the best working practices, used and periodically inspected following the installation, operation and maintenance instructions contained in this document.

Always attach these instructions to the complete equipment.



No modifications, replacements or operations other than those described in this manual are permitted and will result in the invalidity of the ATEX conformity certificate. The protection degree cannot be guaranteed if the components have not been assembled correctly.

Use only **original spare parts** supplied by ILME.

Observe all regulations concerning the inspection and maintenance of electrical plants situated in dangerous areas (EN 60079-17:2014-03). During periodical maintenance, it is particularly important to always inspect the components that guarantee the IP protection degree.

Resistance to chemical agents

Saline solution	Acids		Bases		Solvents				Mineral oil	UV rays
	Concentrated	Diluted	Concentrated	Diluted	Hexane	Benzene	Acetone	Alcohol		
Resistant	Limited resistance	Resistant	Limited resistance	Resistant	Limited resistance	Limited resistance	Limited resistance	Resistant	Resistant	Resistant

INSTALLATION WARNINGS

This product has been designed to be used as an **enclosure for non-sparking components** compliant with ATEX Directive 2014/34/EU, with characteristics compatible with the enclosure and the type of Ex protection. Equipment can be installed both on a DIN-rail EN 60715 and on the bottom plates listed in Table 2 below.

Table 2 - Accessories

Distribution box	DIN-rail EN 60715	Bottom plate
APX 9	APD 9	//
 APX 11	APD 11	APF 11
APX 12	APD 12	APF 12
APX 14	APD 14	APF 14
APX 19	APD 19	APF 19
APX 20	APD 20	APF 20
APX 21	APD 21	APF 21

APX series distribution boxes guarantee resistance to the impacts that may occur in the presence of a low mechanical risk, as stated in the standards.

The enclosure may only be installed if it is intact and free of damage.

Accessories and additional non-sparking components, if present, must be fitted in the enclosure before its installation. Use only original accessories approved by ILME.

Table 3 (on page 4) indicates the location of the drilling “windows” and the size of cable glands, and is intended to provide guidance on the choice of the most suitable cable entry devices.

These devices must comply with the requirements of the ATEX directive, have a category of at least 3GD, an adequate Ex protection type, an IP degree of protection that meets the minimum requirements of the application and a suitable operating temperature range. If the IP degree of protection of the cable entry devices is lower than the one of the box, the protection degree of the whole enclosure is automatically downgraded to the protection value of the cable entry devices.

Always verify that the selected cable glands are suitable for the cables to prevent them from coming loose and ensure that they permanently protect the box from the entrance of humidity and dirt.

Verify the electric continuity between the metal cable glands and the enclosure. Close unused cable entries with suitable ATEX certified plugs.

Mounting holes for cable entry devices must be located within the drillable area defined for each wall, must be drilled in accordance to best working practices and must be free from burrs.

Compared to what is indicated in **Table 3**, remaining within the drilling window, it is possible to reduce the size of the cable entry device or even change its type (e.g.: GAS type), as well as the number of holes, providing - at your own care and responsibility - to:

- check that the dimensions of the operating wrench (with the respective size of the installation tool) and of the diagonal of the selected cable entry devices allow correct mutual installation;
- identify the position of the drilling centres, so that the alternative combination is correct in terms of operational accessibility.

NOTE - These checks are obvious in case of lower number of cable glands for the same dimensions or for smaller cable glands with the same total number.

Table 3 legend



Space occupied by the cable gland

The hexagonal areas shown in the drawings represent the maximum overall dimensions for the cable entry devices of the indicated dimensions (M or Pg).



Drilling window

Represents the area within which the user can drill one or more holes (depending on the indications of Table 3) with the diameters listed in Table 3 in order to fit a cable gland.

Table 3 - Areas that can be drilled for ATEX cable entry devices

Code	Long side					Short side					APX perimeter
	Hole Ø mm	M max	PG max	N° of holes	Drilling window (mm)	Hole Ø mm	M max	PG max	N° of holes	Drilling window (mm)	N° of holes
APX 9	20,2	20		2		20,2	20		1		6
	22,8		16			22,8		16			
APX 11	25,2	25		2		25,2	25		2		8
	28,6		21			28,6		21			
APX 12	25,2	25		2		25,2	25		2		8
	28,6		21			28,6		21			
APX 14	32,2	32		2		32,2	32		2		8
	37,4		29			37,4		29			
APX 19	40,2	40		2		40,2	40		2		8
	47,5		36			47,5		36			
APX 20	63,2	63		2		63,2	63		2		8
	59,8		48			59,8		48			
APX 21	63,2	63		3		63,2	63		2		10
	59,8		48			59,8		48			

When other Ex certified components are fitted in the enclosure, it is essential to take into account all applicable limitations indicated on the respective certificates.

When installing the components, observe the **minimum insulation distances** (surface and air) prescribed for the target application.



Ensure that the **maximum operating temperature** (sum of the ambient temperature and the potential heat generated by non-sparking equipment in the box) is equivalent to $T \leq 85 \text{ }^\circ\text{C}$.

For wall-mounting, use the slots on the external surface of the product only (see **Figure 2**).

The hole to be used to connect the enclosure to the earth conductor is on one of the external walls: use the screw with washer and the lug supplied, as shown in **Figure 2**.

The recommended tightening torque is 1,8 Nm. Perform the equipotential connection between the bottom of the box and the cover using the screws and inserts supplied. The tightening torque is 2 Nm.

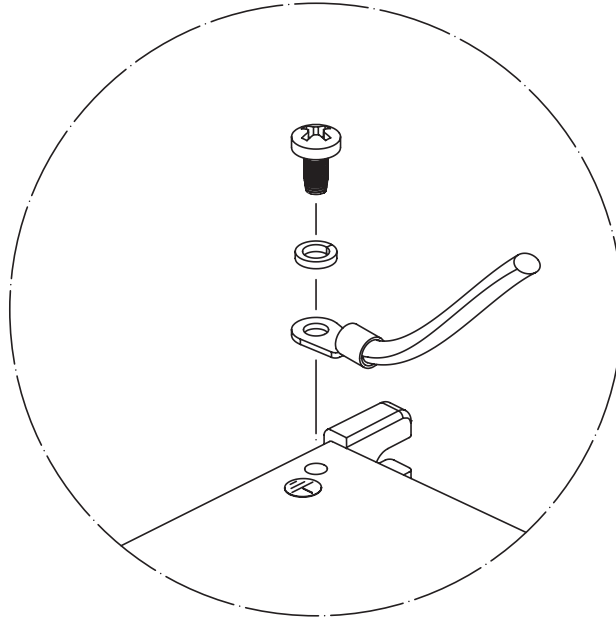

Figure 2 - Detail of the installation of the external equipotential protective earthing and bonding connection

OPERATION AND PERIODICAL MAINTENANCE

Periodical maintenance is essential to ensure that the enclosure is in good working order and able to provide the required protection degree.



Do not open the enclosure (that is, do not loosen the cover screw) **in the presence of explosive atmospheres:** the components inside the enclosure may be very hot!

In this case, it is necessary to allow the enclosure to cool down for a sufficient amount of time and, in the presence of explosive atmospheres, always disconnect the installation upstream before loosening the cover screws.



Potential risk of accumulation of electrostatic charges

In areas where combustible dust is present, it is essential to clean the surface of the upper wall of the enclosure on a weekly basis with a damp cloth only, to prevent the deposited dust from reaching a thickness above 5 mm.

Always check the conditions of the gasket **when opening the enclosure**.

Verify that the closing **screws** are correctly positioned and tightened when closing the enclosure.

Once a year, verify that the wall-mounting screws/bolts are correctly tightened and free from corrosion.

Once a year, **check the tightness of the cable glands** (condition of the gaskets).

Once a year, verify that there are no visible **damages on the enclosure**.

If the parts are damaged or no longer able to guarantee an Ex protection degree, replace the faulty part with a new one (for example the cable gland or the whole box).

DISPOSAL

The product must be disposed of in accordance with national laws and regulations concerning the disposal and recycling of industrial waste. Products are compliant with Directive RoHS 2002/95/EC and subsequent amendments with exemptions 6(b) and 6(c).

CE MARKING

The CE marking on the box cover indicates that the product complies with the Low Voltage Directive 2014/35/EU.

Attachment 1 - Classification legend

Symbol	Meaning
	Manufacturer's logo (ILME S.p.A.)
Via M. A. Colonna 9 20149 Milano (ITALY)	Manufacturer's address (mandatory for ATEX Directive 2014/34/EU)
CE	CE marking that indicates conformity with the Low Voltage Directive 2014/35/EU NOTE -as an Ex component, no CE marking is required by the ATEX Directive 2014/34/EU, nor by the RoHS 2 Directive 2011/65/EU + 2015/863/EU
APX 14	Reference to type of product (product code)
	Ex symbol that indicates the specific marking related to the protection against the risk of explosion referred to in ATEX Directive 2014/34/EU
II	Group, indicates the type of intended use for which the product is suitable: Group II = Surface industries (Group I = Mining sites)
3GD	Category that identifies the equipment protection level: Category 3 = Ordinary risk of explosion (for Zones 2 and 22) G = Protection from gases D = Protection from dust
Ex nA	Ex protection type <u>for protection from gases</u> : product designed to be used with non-sparking equipment "nA" (that does not produce electric arcs or sparks)
IIC	Group II of electrical equipment designed for explosive atmospheres, for type C gases (typically hydrogen)
T6	Temperature class (85 °C)
Gc	Protection level assigned for explosive atmospheres containing gases (G = Gas). EPL Gc Equipment protection level (EPL) equivalent to c ("increased")
U	Symbol that confirms that the product is classified as an Ex component (gases)
X	Symbol indicating that the Ex product must follow special instructions (those provided in this manual)
Ex tc	Protection type <u>against explosive dust</u> with enclosure "t", for protection level "tc" (= Equipment protection level EPL = "Dc", see below)
IIIC	Group III of electrical equipment designed for explosive atmospheres containing dust other than mining sites, for conductive dust
-20 °C ≤ Ta ≤ 85 °C	Assigned ambient temperature range
Dc	Protection level assigned for explosive atmospheres containing dust (D = Dust). EPL Dc Equipment protection level (EPL) equivalent to c ("increased")
IP66/IP67	IP protection degree against the penetration of dust (first characteristic digit) and liquids (second characteristic digit) in accordance with CEI EN 60529: IP66 = Dust-tight and protected against powerful water jets IP67 = Dust-tight and protected against temporary immersion in water
U	Symbol that confirms that the product is classified as an Ex component (dust)
X	Symbol indicating that the Ex product must follow special instructions (those provided in this manual)
A-ZYYMMDD	Traceability code that identifies the production lot (A = Product revision, Z = Code for internal use, YYMMDD = Production date (YY = Year, MM = Month, DD = Day))
ILME 16.0001	Name of the subject that has issued the certificate of conformity to the applicable ATEX standards: self-certified ATEX component (ILME); 16 = Last two digits of the year in which the certificate has been issued; 0001 = Progressive number of the certificate issued in the specific year



Milano, 20/12/2021

Our ref.: ATEX/AC_01G/2021

Your ref.:

Subject: **Attestation of conformity for Ex components
ATEX Directive 2014/34/EU**

ATTESTATION OF CONFORMITY FOR EX COMPONENTS

No.	01/2021
Manufacturer's name	I.L.M.E. S.p.A.
Address	via Marco Antonio Colonna, 9 – 20149 Milan – Italy
Subject of the Attestation	Distribution box – series APX ATEX
	Cat. no.
	APX 9
	APX 11
	APX 12
	APX 14
	APX 19
	APX 20
APX 21	

We hereby declare under our own responsibility that the products referenced above are compliant with the requirements of the following standards:

Standard	Title
EN IEC 60670-1:2021 EN IEC 60670-1:2021/A11:2021	Boxes and enclosures for electrical accessories for household and similar fixed electrical installations — Part 1: General requirements
EN 60670-22:2006	Boxes and enclosures for electrical accessories for household and similar fixed electrical installations — Part 22: Particular requirements for connecting boxes and enclosures
EN IEC 60079-0:2018 EN IEC 60079-0/AC:2020	Explosive atmospheres — Part 0: Equipment — General requirements
EN 60079-15:2010	Explosive atmospheres — Part 15: Equipment protection by type of protection “n”
EN 60079-31:2014	Explosive atmospheres — Part 31: Equipment dust ignition protection by enclosure ‘t’

ADDITIONAL INFORMATION

Products are classified as **Group II components** (surface industries), **category 3GD** (gas and dust) in accordance with the requirements of the ATEX Directive 2014/34/EU and are therefore suitable to be used in all areas classified as **zone 2** for gas and **zone 22** for dust.

For the conditions of use, refer to the installation, operation and maintenance instructions of which this Attestation forms an integral part.

I.L.M.E. S.p.A.
President and CEO

ILME S.p.A. Industria Lombarda Materiale Elettrico

Via Marco Antonio Colonna, 9
20149 Milano (MI), Italia

Ufficio Italia Ufficio Export
T +39 02 3456051 T +39 02 3456052
F +39 02 316330 F +39 02 33105813

C.F. / P.IVA / n. iscr. Reg. Imprese 00886300151
VAT n. IT 00886300151
Codice Destinatario SDI: P43TKPP
R.E.A. MI - 338129
Cap. Soc. € 5.400.000 i.v.

www.ilme.com
info@ilme.com

ISO 9001:2015
Certificato n. 50 100 11133





Milano, 20/12/2021

Our ref.: PB/pb/CE-29/21 rev. A

Your ref.:

Subject: **EU Declaration of conformity
Low Voltage Directive 2014/35/EU**

We declare under our own responsibility that the products **junction boxes** and relevant accessories

series APX

cat. nos. **APX 9/ 11/ 12/ 14/ 19/ 20/ 21**
cat. nos. **APF 11/ 12/ 14/ 19/ 20/ 21**

comply with the European Standards **EN IEC 60670-1:2021 + EN IEC 60670-1/A11:2021** (Italian Standard **CEI 23-48**) and **EN 60670-22:2006** (Italian standard **CEI 23-94**), therefore they comply with the essential safety requirements of the Low Voltage Directive **2014/35/UE**.

12
(last two digits of the year of first CE marking)

I.L.M.E. S.p.A.
President and CEO

ILME S.p.A. Industria Lombarda Materiale Elettrico

Via Marco Antonio Colonna, 9
20149 Milano (MI), Italia

Ufficio Italia Ufficio Export
T +39 02 3456051 T +39 02 34560522
F +39 02 316330 F +39 02 33105813

C.F. / P.IVA / n. iscr. Reg. Imprese 00886300151
VAT n. IT 00886300151
Codice Destinatario SDI: P43TKPP
R.E.A. MI - 338129
Cap. Soc. € 5.400.000 i.v.

www.ilme.com
info@ilme.com

ISO 9001:2015
Certificato n. 50 100 11133



**Distribution boxes APV / APS / APW series
Boxes for control devices and signals AC series**

APV

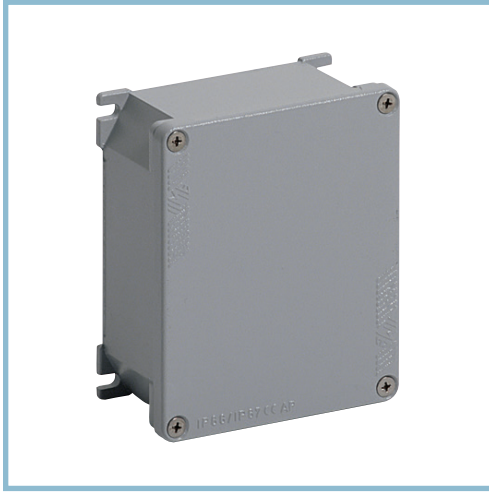

APS

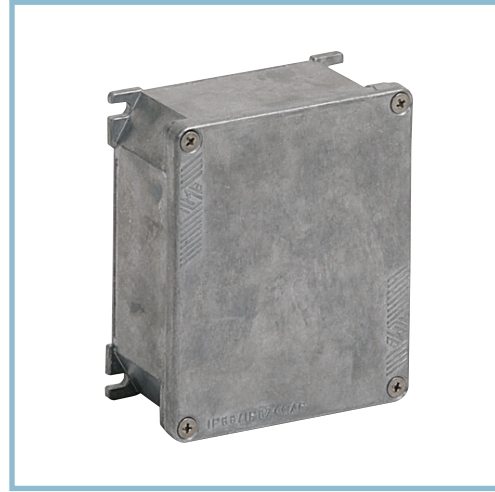

APW

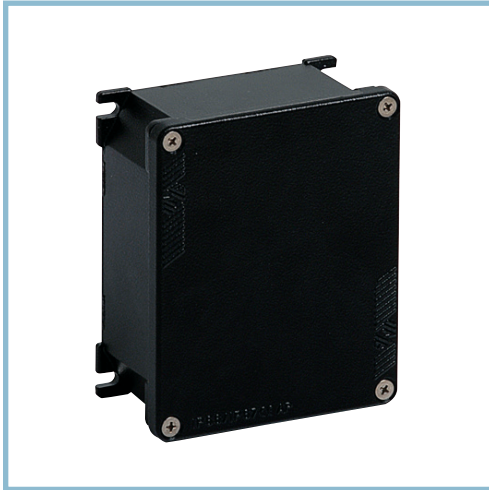

AC

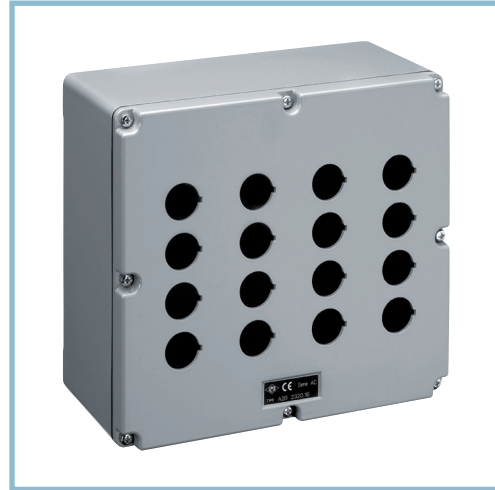

TM ATEX socket-outlets with mechanical interlock



For further information
please contact **ILME S.p.A.**



Worldwide Sales Organization

Headquarters

ILME S.p.A.
Via M.A. Colonna, 9
20149 Milano, Italia
T +39 0234560522
info@ilme.com

France

ILME FRANCE S.A.R.L.
431 rue Roland Garros
Parc d'Activités de l'Aéroport
42160 Andrézieux-Bouthéon
T +33 04 7736 2336
ilme-france@ilme.fr

Germany

ILME GmbH
Max-Planck-Straße 12
51674 Wiehl
T +49 (0)2261 7955 0
technik@ilme.de

Sweden

and Nordic Countries

ILME NORDIC AB
Transportvägen 18
246 42 Löddeköpinge
T +46 4618 2800
info@ilme.se

United Kingdom

ILME UK LIMITED
50 Evans Road, Venture Point
Speke, Liverpool L24 9PB
T +44 0151 336 9321
sales@ilmeuk.co.uk

Czech Republic

Representative Office

ILME S.p.A.
Business Center Rokytká
Sokolovská 270/201
Vysocany, Praha 9, 190 00
info@ilme.cz

China

ILME CHINA CO. LTD.
Room 101, Building 3
188 Xinjunhuan Road, Minhang
Shanghai 201114
T +86 21 6248 9961
info@ilmechina.com

Japan

ILME JAPAN CO. LTD.
K.I.B.C. Bldg 5-2
Minatojima Minamimachi 5-Chome
Chuo-Ku, Kobe 650-0047
T +81 78 302 2005
info@ilmejapan.co.jp

South Korea

ILME KOREA CO.
714, DaeRyung Technotown 20th
5 Gasan Digital 1-Ro, GeumCheon-Gu
Seoul 08594
T +82-2-2225-8432
sales@ilme.kr

www.ilme.com

www.ilme.com

XDG APX 1221



catalogues