

Multipole connectors JEI® series

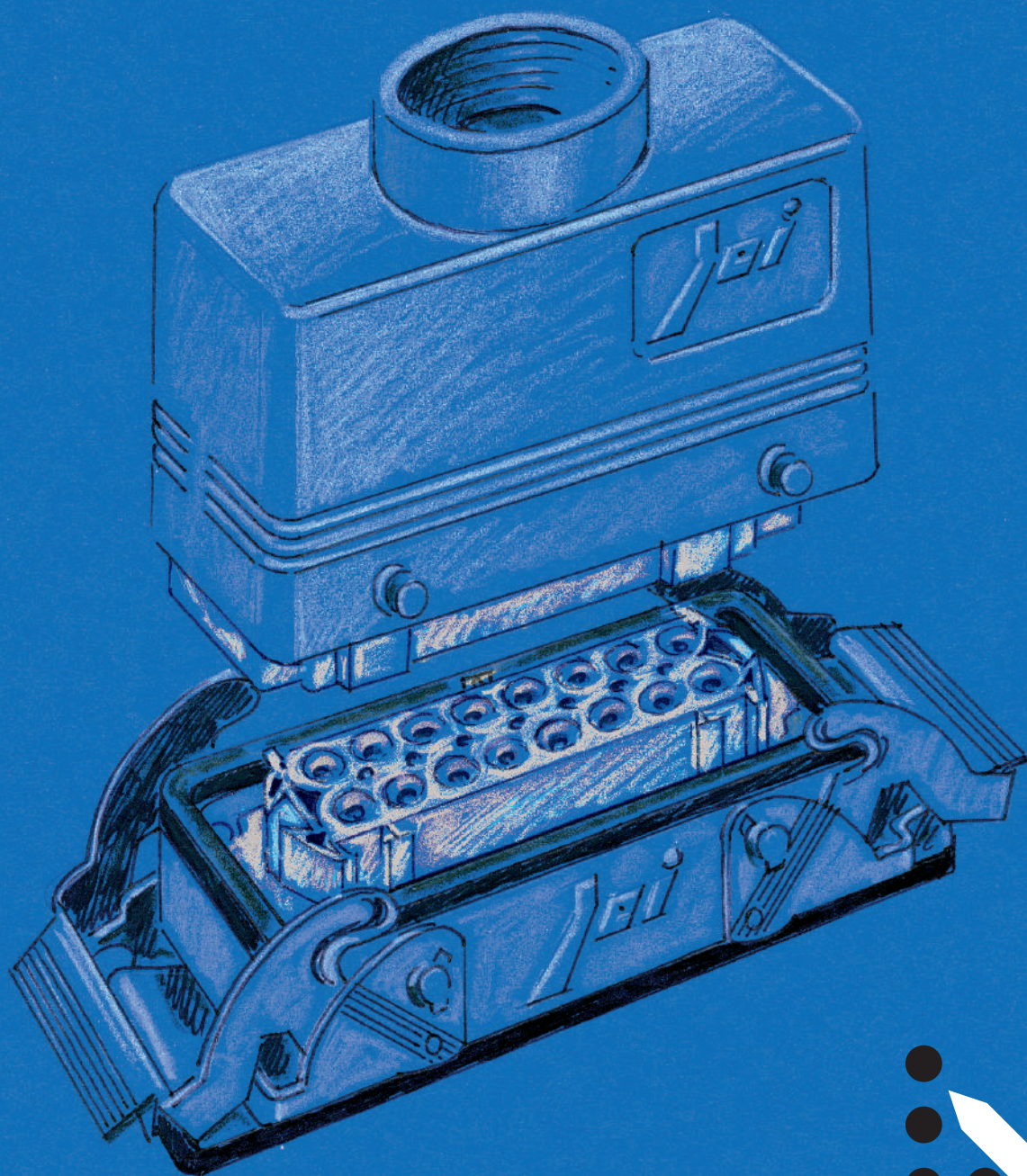

The Company and the Product

INDUSTRIA LOMBARDA MATERIALE ELETTRICO SpA has been operating in Milan since 1938, in particular in the electrotechnical sector for the manufacturing of equipment for industrial installations.

ILME reflects the traditional **entrepreneurial spirit of Lombardy**, and has enjoyed continuous expansion for over half a century.

The company has carved an important role for itself in the main world markets, also operating directly in the countries that have assumed world leadership in the field of automation, including Germany and Japan.

In the **electrical connection** sector with applications in industrial automation, characterised by **top performance** and utmost **reliability needs**, ILME is today the acknowledged partner of many leading companies worldwide.

The company's fundamental values are:



product innovation, original solutions, excellent **price-quality ratio**, a customer-oriented **sense of service**, ethical behaviour and an environmentally-friendly approach.

To promote the continuing improvement of its **qualitative results**, ILME has always encouraged its collaborators to work with utmost **responsibility and participation**.

The company focuses on a series of benefits to the user, including research into the most suitable materials, high quality and safe cabling, a rapid turnaround and readily available services.

CE marking

As from 1 January 1997, in order to launch electrical products on the European market the manufacturer must ensure these bear the relevant CE marking, in line with the Low Voltage Directive 73/23/EEC * (implemented in Italy as law 18-10-1977 no. 791) and its modification 93/68/EEC * (implemented in Italy as L. D. 25-11-1996 no. 626/96, published in the supplement to the Gazzetta Ufficiale of 14-12-1996).

Said marking must be placed on the product - or, if this is not possible, on the packaging, the instructions for use or the warranty certificate - and acts as a declaration by the manufacturer that the product complies with all relevant EU directives.

ILME products bear the CE marking on the product or packaging.

Almost all ILME products fall under the Low Voltage Directive. A declaration of compliance is required before applying the CE marking. This document, to which the market is not directly entitled, must be made available to the control authorities (in Italy the Ministry for Industry, Commerce and Handicraft) at all times.

In it, the manufacturer declares the technical safety standard(s) followed to manufacture the product. These standards must be, in decreasing order of preference:

- a European standard (EN prefix)
- a European harmonisation document (HD prefix)
- an international IEC standard
- a national standard
- in the absence of reference standards, the manufacturer's internal specifications, guaranteeing compliance with the directive's basic safety requirements.

Compliance with harmonised technical standards (i.e. ratified by the CENELEC) constitutes presumed conformity to the directive's basic safety requirements.

The CE marking of ILME products results from said products' declaration of conformity to harmonised standards or international IEC standards.

Through the CE marking, ILME declares full compliance, not merely with the directive's basic safety requirements, but also with those international or national EU standards on which voluntary safety certification markings are based (e.g. IMQ and VDE).

In this way, ILME intends to award the CE marking the value of self-certification in terms of safety, given the loss in legal value of voluntary certifications issued by third parties, ratified by directive 93/68/EEC *.

Notwithstanding the above, practically all ILME products still bear voluntary conformity markings.

This EC declaration of conformity becomes null and void when the assembly of products includes one or more components not manufactured by us and without EC approval.

* Note:

new legal reference for the Low Voltage Directive is 2006/95/EC which is the consolidated edition of Directive 73/23/EEC + Directive 93/68/EEC.

On March 29, 2014, the new Low Voltage directive 2014/35/EU has been published on the Official Journal of the European Union, as a recast of the previous directive 2006/95/EC. It will enter into force on April 20, 2016.

All information contained in this catalogue is not binding and may be changed without notice

Inserts

JK
Screw terminal connection
10A - 230/400V

page 27



JKS
Spring terminal connection
10A - 400V

from page 28



CD
Crimp connection
10A - 250V
10A - 50V

from page 30

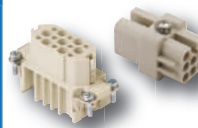

CDD
Crimp connection
10A - 250V

from page 39



JDA
Screw terminal connection
16A - 250V

from page 48



JDS
Spring terminal connection
10A - 400V

from page 50



JSH
SQUICH® connection
16A - 500V

from page 60

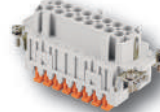

JNE
Screw terminal connection
16A - 500V

from page 68



JSE
Spring terminal connection
16A - 500V

from page 68



CCE
Crimp connection
16A - 500V

from page 74



CQE
Crimp connection
16A - 500V

from page 80



Enclosures

JEI®-P from page 88

- Metallic
- Thermoplastic lever
- IP65



JEI®-V from page 102

- Metallic
- Galvanised steel lever
- IP66



CK - CKA from page 123

- Standard insulating version
- Standard metallic version



T-TYPE from page 128

- Insulating
- Robust
- Chemical resistant
- IP65



Complements and accessories

COB

- Mounting inside control panel
- Inspectable

from page 142



Accessories

from page 146



Dust protection cover

- For versions
JEI®-P
JEI®-V

page 149



Manual crimping tool

CCPZ TP

page 153



Choose JEI® for standard applications

JEI® connectors are used for the electrical and electronic connection of machines, control units, electric panels, control equipment and where a safe sectionable connection is required.

They can be used in non-aggressive industrial environments (for example, automatic assembly machines for working wood or plastic) and wherever there is a need for connections with an optimum quality/price ratio.

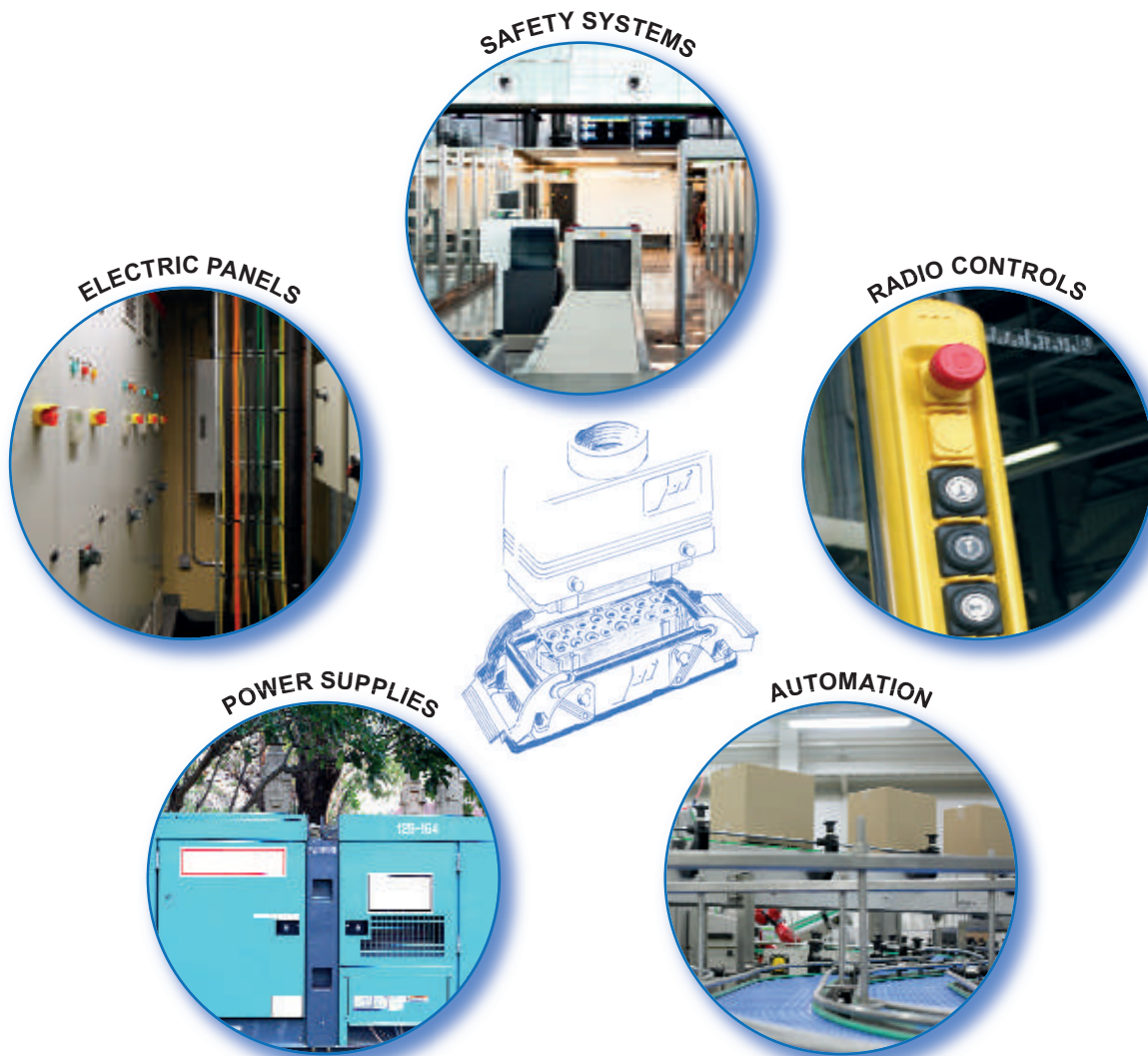

The JEI® series consists of inserts manufactured in UL 94 V-0 type-approved thermoplastic resin and contacts with a galvanic tin coating.

Coupling with metallic enclosures, complete with locking levers in reinforced thermoplastic or galvanised steel, makes the connection effective and robust.

The wide range of inserts available with different termination methods (screw, crimp or spring) guarantees flexibility of use.

JEI® inserts for standard connections

Reliable and precise tin-plated contacts

Brass contacts with tin plating which guarantee up to 200 mating cycles.

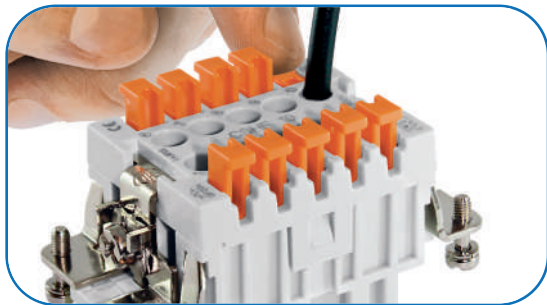
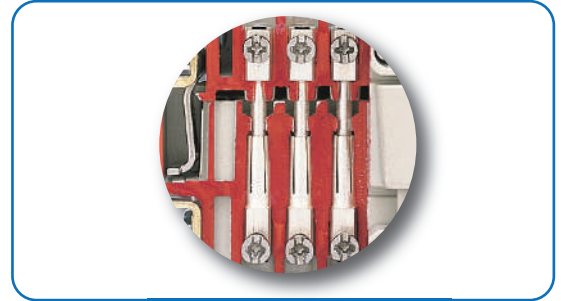

JSH inserts: “SQUICH®” quick connection

The innovative solution that eliminates the need for tools in the wiring stage.

The connections are made by simply pressing a pushbutton.

The result? A reduction in cabling time of 50% compared to screw-type connections and 20% compared to conventional spring-type connections.

JDS inserts: Greater pole density in the same standard space

The inserts that can offer up to 84 poles in the same space as a standard 48-pole connector, thanks to its compact spring termination method which has allowed for the number of poles to be increased without changing the overall dimensions.”

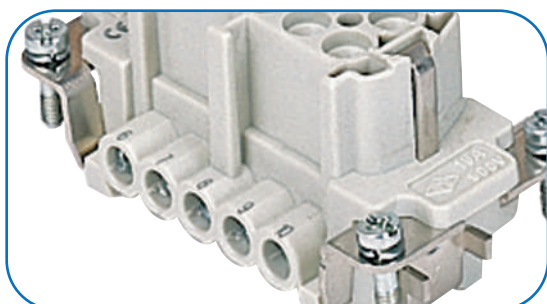

JNE - JDA inserts: connection of conductors up to 4 mm²

These screw termination inserts can house conductors up to 4 mm². The mixed head screw lets you use a flat or Phillips head screw.

The JEI® enclosures make all the difference

Select the levering system that best suits your needs

Two types of lever to create the best connection:

- JEI®-V galvanized steel levers with vertical closure
- JEI®-P with levers in thermoplastic material.



Closing covers in thermoplastic material

The enclosures with JEI®-V series levers, in galvanized steel, may be provided with hinged thermoplastic covers. Sizes available: 44.27, 57.27, 77.27, 104.27, 77.62, 104.62.

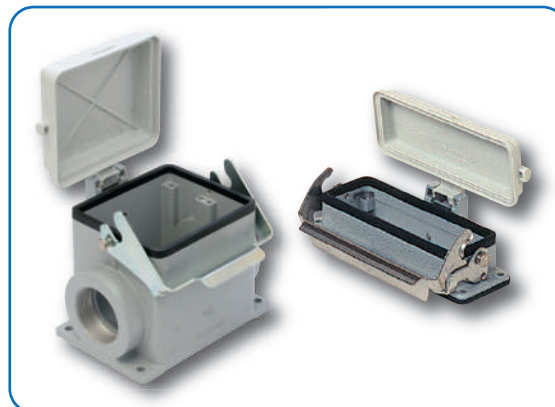

The JEI® series comes complete with:

The only enclosure with vertical closure

The exclusive V-TYPE lever system, with vertical opening and closure, guarantees IP66 protection rating and minimises mobile enclosure pin friction and wear even with frequent coupling.

The V-TYPE levers are available in sizes 44.27, 57.27, 77.27 and 104.27.

OPEN

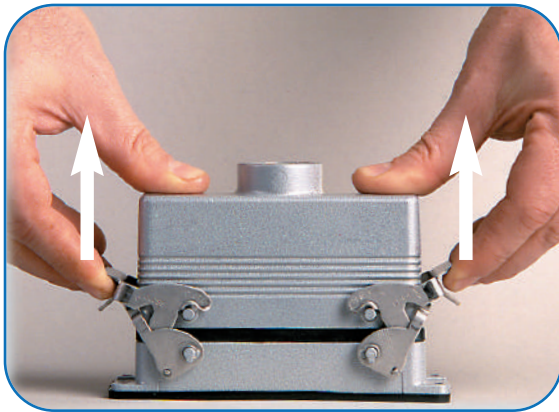

CLOSE

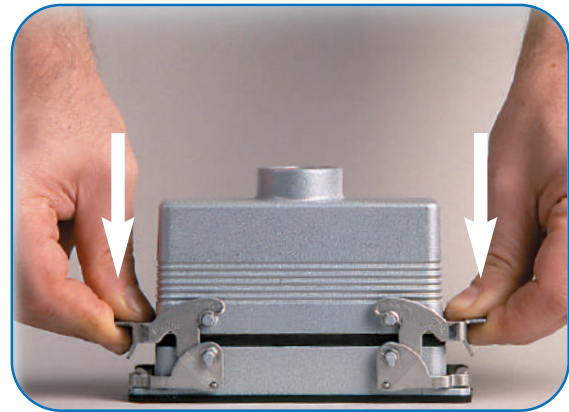

T-TYPE enclosures: resistant and cost effective

Made entirely of highly thick thermoplastic material, they guarantee considerable structural solidity and mechanical durability, combined with significant resistance to the main aggressive agents in industrial environments.

Ideal for environments where paint is discouraged.



ILME designs and manufactures complete solutions for Heavy Duty electrical power connections.

The connector (although offered to the user as a variety of elements, usually inserts and enclosures, to allow the selection of the ideal combination) has been **designed as complete connector** and tested to be compliant with the essential safety requirements of the EU Low Voltage Directive 2006/95/EC and in particular the EN 61984 standard.

The design of this "whole" system guarantees that every allowed combination of inserts, enclosures and accessories cannot result as improper.

The products in this catalogue alone cannot guarantee the best functionality upon installation, as this depends also on their correct **"installation into service"** which must be performed in compliance with the applicable system safety standards and according to the "rule of the art". Therefore the effectiveness of the installation of the connector depends on the choices of the end user who must also take into account the following safety requirements.

Connectors must **not be connected or disconnected when live or under load**.

After wiring the inserts it is necessary to **verify the continuity of the protective earth connections**.

The correct coupling of the inserts is guaranteed only if they are installed (with the four fixing screws supplied) inside the corresponding enclosures or onto compatible accessories in this catalogue. I.L.M.E. SpA is not responsible for any different application.

Wiring of **screw-type terminal connections** must be carried out applying the correct tightening torque in order to avoid false contacts or damage to the conductor, the screw or the terminal.

Crimping tools and contacts used should preferably be supplied by the same manufacturer to avoid difficulties with the insertion and retention of the contacts themselves.

Correct wiring of spring-clamp connection inserts is guaranteed only when the correct screwdriver indicated in the specific catalogue, or possibly on the insert, is used.

Avoid forcing the contacts during **connection and disconnection**.

Connectors must be coupled and uncoupled in the axial direction with respect to the contacts, without bending and pulling the attached conductor bundles or cables.

Installation of two **inserts side by side**, in enclosures with two bays, must respect the polarity drawing marked on the insert (or the contact side view, as shown in this catalogue) to avoid inverted coupling.

The installation of two or more identical connectors side by side is recommended only with the use of coding pins in order to avoid mismatched couplings.

In order to keep the declared degree of protection (IP code), enclosures must be completed with cable glands and/or other accessories with at least an equal protection rating.

Moreover, the IP protection rating (according to EN 60529) is guaranteed when the enclosures, complete with inserts, are coupled and locked with their locking levers (or devices).

Finally, Please note:

- ILME cannot be held responsible for individual components in uses other than those described in this catalogue.
- ILME cannot be held responsible for incorrect connector selection in relation to the environmental conditions of the application (e.g.: influence of ambient temperature, moisture, environmental pollution, etc.).

Connector inserts and their enclosures are generally compatible with similar/equivalent products from other manufacturers, according to the last samples tested.

Full compatibility cannot be guaranteed in the event of technical changes made by other manufacturers. In particular, maximum performance of IP68 enclosures (Series CG) cannot be guaranteed when coupled with other manufacturers' products.

I.L.M.E. SpA takes no responsibility in verifying whether the components herein contained comply with any specific regulations of fields of application.

Inserts

The JEI® inserts are made of UL 94 V-0 self-extinguishing thermoplastic resin and can be used in environments with temperatures up to 125 °C. Different termination methods are available: screw, crimp or spring connections.

Inserts are numbered on both sides by laser printing or moulding.

Choose the insert that best suits your needs based on the rated voltage (from 50 to 500V), the rated current (from 10A to 16A max), the number of poles and the termination method:

- JK 3-4 poles + ⊕ with screw terminal connection
- JKS 3-4 poles + ⊕ with spring terminal connection
- JDS 9, 18, 27, 42, (54), (84) poles + ⊕ with spring terminal connection
- JDA 10,16 (32) poles + ⊕ with screw terminal connection
- JNE 6, 10, 16, 24, (32), (48) poles + ⊕ with screw terminal connection
- JSE 6, 10, 16, 24, (32), (48) poles + ⊕ with spring terminal connection
- JSH 6, 10, 16, 24, (32), (48) poles + ⊕ with SQUICH® quick connection.

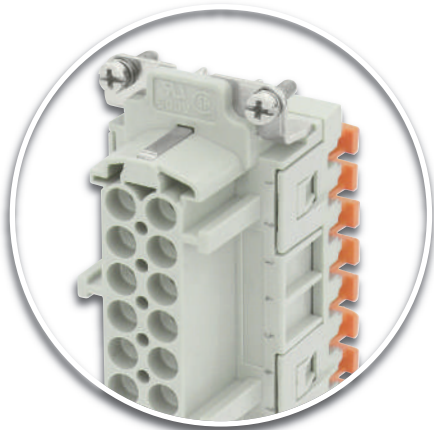

SQUICH®
connections
without tools



SPRING terminal
connection
HIGH DENSITY

**TIN PLATED
CONTACTS**



SCREW terminal
connection



SPRING terminal
connection

inserts	No. of poles ¹⁾	auxiliary contacts	rated current ³⁾	EN 61984 (2001-11) pollution degree 3			EN 61984 (2001-11) pollution degree 2			UL/CSA ²⁾ certification	certifications ²⁾
				rated voltage	rated impulse withstand voltage	pollution degree	rated voltage	rated impulse withstand voltage	pollution degree		
series	main contacts + ⊕										
JK	3, 4	---	10A	230/400V	4kV	3				600V	UL, EAC
JKS	3, 4	---	10A	400V	4kV	3				600V	cUL, EAC
JDS	9, 18, 27, 42, (54), (84)	---	10A	400V	6kV	3	400/690V	6kV	2	600V	UL, EAC
JDA	10, 16	---	16A	250V	4kV	3	230/400V	4kV	2	600V	cUL, EAC
JNE	6, 10, (12), 16, 24, (32), (48)	---	16A	500V	6kV	3	400/690V	6kV	2	600V	UL, EAC
JSE	6, 10, (12), 16, 24, (32), (48)	---	16A	500V	6kV	3	400/690V	6kV	2	600V	UL, EAC
JSH	6, 10, (12), 16, 24, (32), (48)	---	16A	500V	6kV	3	400/690V	6kV	2	600V	UL, EAC

Crimp inserts that may be used with JEI® series tin-plated/gold-plated crimp contacts

inserts	No. of poles ¹⁾	auxiliary contacts	rated current ³⁾	EN 61984 (2001-11) pollution degree 3			EN 61984 (2001-11) pollution degree 2			UL/CSA ²⁾ certification	certifications ²⁾
				rated voltage	rated impulse withstand voltage	pollution degree	rated voltage	rated impulse withstand voltage	pollution degree		
series	main contacts + ⊕										
CD	8 (without ⊕)	---	10A	50V	0,8kV	3				50V	UL, CSA, CCC, GL, EAC
CD	7, 15, 25, 40, (50), 64, (80), (128)	---	10A	250V ⁴⁾	4kV	3	230/400V ⁴⁾	4kV	2	600V	UL, CSA, CCC, GL, EAC
CDD	24, 38, 42, 72, (76), 108, (144), (216)	---	10A				250V	4kV	2	600V	UL, CSA, CCC, GL, EAC
CCE	6, 10, (12), 16, 24, (32), (48)	---	16A	500V	6kV	3	400/690V	6kV	2	600V	UL, CSA, CCC, EAC
CQE	10, 18, (20), 32, 46, (64), (92)	---	16A	500V ⁴⁾	6kV	3	830V ⁴⁾	8kV	2	600V	UL, CSA, CCC, EAC

N.B.: all inserts have a mechanical life equal to or higher than 500 coupling cycles (200 cycles for tin-plated crimp contacts)

- 1) Polarities shown in brackets may be achieved by using two inserts.
- 2) The certifications shown in brackets are pending.
- 3) Please check the insert load curves to establish the actual maximum operating current according to the ambient temperature.
- 4) Contacts partially fitted inside an insert allow inserts to be used for applications requiring rated voltages higher than those shown. See tables on page 30 (CD inserts), page 39 (CDD inserts) and page 80 (CQE inserts).

- cUL - UL for USA and Canada
- UL - with protocol E 115072
- CSA - with protocol LR 82270
- CCC - China Quality Certification
- GL - Germanischer Lloyd - 3356706 HH
- EAC - Eur Asian Certification

inserts	contact resistance	insulation resistance	ambient temperature limit (°C)		degree of protection		conductor connection		page No.
			min	max	without enclosures	with enclosures	screw	spring	
series	≤	≥							
JK	≤ 1 mΩ	≥ 10 GΩ	-40	+100	IP20	IP44, IP66/IP67	✓		27
JKS	≤ 3 mΩ	≥ 10 GΩ	-40	+125	IP20	IP44, IP66/IP67		✓	28 ÷ 29
JDS	≤ 3 mΩ	≥ 10 GΩ	-40	+125	IP20	IP65, IP66		✓	50 ÷ 59
JDA	≤ 1 mΩ	≥ 10 GΩ	-40	+125	IP20	IP65	✓		48 ÷ 49
JNE	≤ 1 mΩ	≥ 10 GΩ	-40	+125	IP20	IP65, IP66	✓		68 ÷ 73
JSE	≤ 3 mΩ	≥ 10 GΩ	-40	+125	IP20	IP65, IP66		✓	68 ÷ 73
JSH	≤ 3 mΩ	≥ 10 GΩ	-40	+125	IP20	IP65, IP66		✓	60 ÷ 67

inserts	contact resistance	insulation resistance	ambient temperature limit (°C)		degree of protection		conductor connection		page No.
			min	max	without enclosures		crimp		
series	≤	≥							
CD	≤ 3 mΩ	≥ 10 GΩ	-40	+125	IP20		✓		32
CD	≤ 3 mΩ	≥ 10 GΩ	-40	+125	IP20		✓		31 ÷ 38
CDD	≤ 3 mΩ	≥ 10 GΩ	-40	+125	IP20		✓		40 ÷ 46
CCE	≤ 1 mΩ	≥ 10 GΩ	-40	+125	IP20		✓		74 ÷ 79
CQE	≤ 1 mΩ	≥ 10 GΩ	-40	+125	IP20		✓		81 ÷ 86

Several versions of enclosures are available, made in either a die cast aluminium alloy with an epoxy-polyester powder coating or in self-extinguishing thermoplastic material. They are resistant to impact and strong mechanical stress. The coupling stability and protection against accidental opening are assured by single or double closing devices comprising levers, springs and pegs in galvanised steel or entirely in plastic. Sealing is assured by special gaskets that protect the contact groups inside the enclosures against dust and aggressive agents. In general, the coupled enclosures with the appropriate user-selected connections guarantee IP44, IP65, IP66 and IP67 (IEC EN 60529) protection rating.

The die cast aluminium alloy enclosures are made in the following versions:

- JEI®-P with 1 and 2 levers in thermoplastic material
- JEI®-V with 1 lever in galvanized steel
- JEI®-V with 1 lever in galvanized steel and plastic cover
- JEI®-V with 2 levers in galvanized steel



It is also possible to use the JEI® inserts in combination with the **T-TYPE** enclosures: the series of enclosures made entirely of self-extinguishing thermoplastic material.

The combination of JEI® inserts and **T-TYPE** enclosures extends the field of application of this series to environments where powder paint is discouraged.



Most of the enclosure versions have been certified by UL as Recognized Components for the USA and Canada (cUL mark) and hence are suitable accessories for our set of UL and CSA certified connector inserts (file UL E115072, file CSA 082270_0_000).

The certification has been achieved by successfully completing several tests carried out in compliance with standard ANSI/UL 50 (Enclosures for Electrical Equipment) which is equivalent to the North American voluntary standard NEMA 250 (NEMA = National Electrical Manufacturers Association) and to the equivalent Canadian standard CSA C22.2 No.94 (Special Purpose Enclosures) for the protection ratings used in North America and required by the local installation codes (e.g.: NFPA 70 National Electrical Code in the US, CSA system standards for Canada); more specifically:

- Type 12 (= NEMA 12): for internal use, similar to IP54 protection rating according to IEC/EN 60529;
- Type 4 (= NEMA 4): for internal and external use, similar to IP66;
- Type 4X (= NEMA 4X): for internal and external use, as Type 4 + corrosion resistance, similar to IP66 protection rating.

The **new RoHS directive II 2011/65/EU** of 8 June 2011, as amended, is in effect as of 3 January 2013 with the revocation of the old RoHS directive 2002/95/EC and subsequent amendment 2008/35/EC.

This directive had introduced a ban on the use of some hazardous substances in new Electrical and Electronic Equipment (EEE) introduced on the market as of 1 July 2006.

The exceptions for some applications were listed in the Directive Annex and in a certain number of subsequent EU Commission Decisions ²⁾.

The new RoHS II directive confirms the banned and/or restricted substances: **Lead, Mercury, Cadmium, Hexavalent Chromium, Poly-Brominated By-Phenyls** and **Poly-Brominated Dy-Phenyl Ethers** (PBB and PBDE respectively, fire retardant substances for thermoplastic materials).

The single components and finished product parts are excluded from the field of application.

Multi-polar connector inserts, the relevant removable crimp contacts and the connector enclosures are excluded from the field of application of the new RoHS II Directive. Each of these "components" still meets the RoHS II directive, in their capacity as possible finished product components that already are or will be included in the field of application at the end of the transitory period (22 July 2019), when the scope of the RoHS II directive will open to include any electric and electronic equipment (EEE).

CE markings for finished products, one of the biggest new features in the new directive, is not required for components, as with the EU Declaration of Conformity.

All ILME products in this catalogue do not contain any of the limited substances in concentrations over and above those admitted by the directive and are thus compliant with the **new directive 2011/65/EU (RoHS II) issued by the European Parliament and Council on 8 June 2011 on the restricted use of some hazardous substances in electric and electronic equipment** and subsequent amendments ¹⁾ within the terms of its field of application and the transitory periods established therein for each EEE electric and electronic equipment category.

Specifically, **multi-polar connector products for industrial use, removable crimp contacts, multi-polar electric connector enclosures**, and all the relevant accessories are compliant, although not within its field of application.

PLEASE NOTE – This is not an EU Declaration of Conformity and CE markings, which could be found in accordance with other applicable EU Directives, do not refer to the RoHS II Directive.

1) At the time of publication of this Catalogue: Directives delegated of the Commission 2012/50/EU and 2012/51/EU of 10 October 2012.

2) At the date of replacement of the old RoHS Directive (3 January 2013) the following Decisions of the Commission were in force: **M1** 2005/618/EC of 18 August 2005, **M2** 2005/717/EC of 13 October 2005, **M3** 2005/747/EC of 21 October 2005, **M4** 2006/310/EC of 21 April 2006, **M5** 2006/690/EC, **M6** 2006/691/EC and **M7** 2006/692/EC of 12 October 2006, **M9** 2008/385/EC of 24 January 2008, **M10** 2009/428/EC of 4 June 2009, **M11** 2009/443/EC of 10 June 2009, **M12** 2010/122/EU of 25 February 2010, **M13** 2010/571/EU of 24 September 2010, **M14** 2011/534/EC of 8 September 2011.

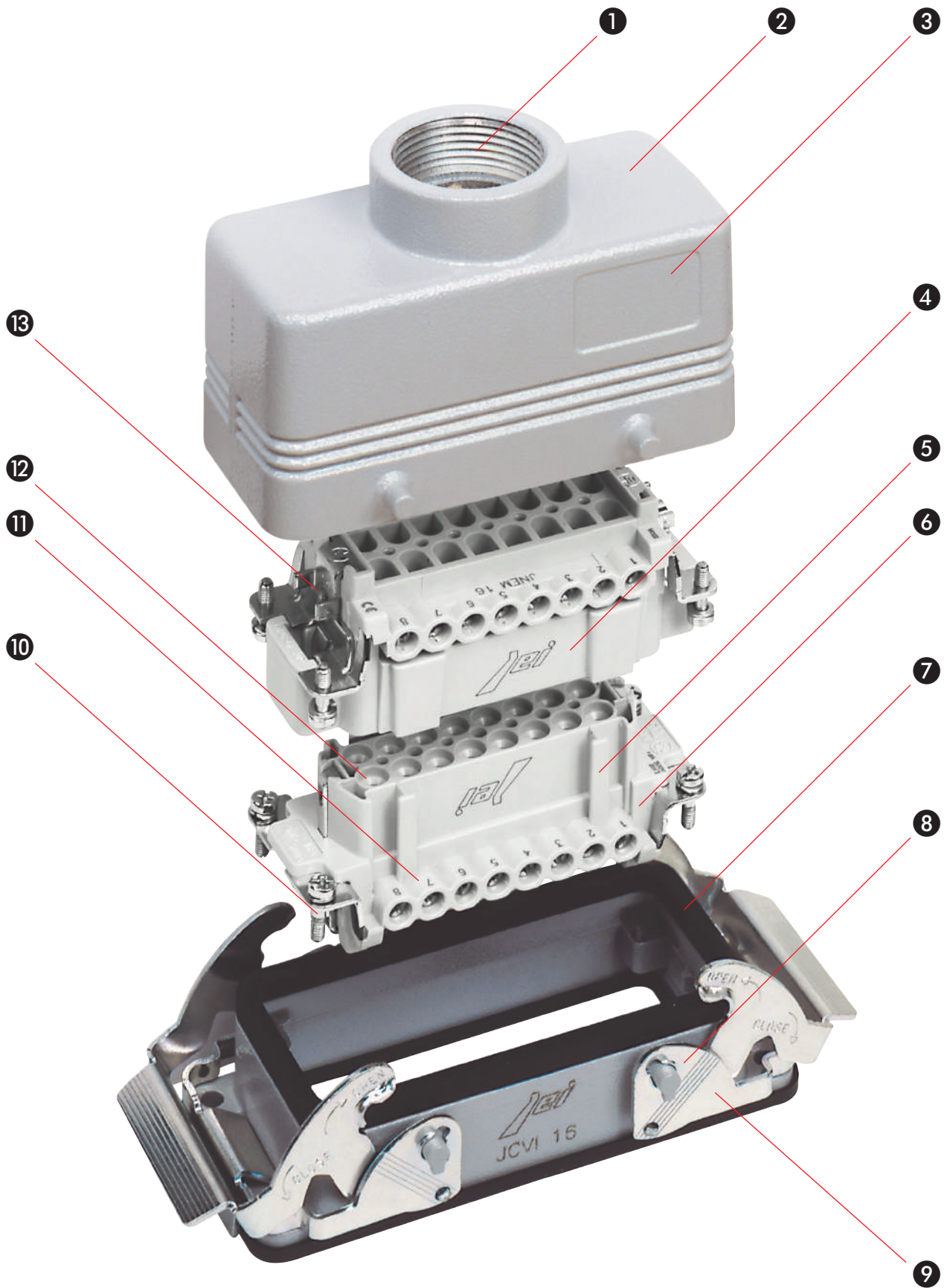

- ❶ Threaded cable passage in various Pg diameters (types with pre-code "C") or metric passage (types with pre-code "M") in accordance with EN 60423, for cable entry devices in accordance with EN 50262 (NPT threading on request), may be located vertically, horizontally or frontally.
- ❷ Rugged die-cast aluminum alloy or self-extinguishing thermoplastic enclosures (types CK, MK, **T-TYPE**). Surface-mounting bulkhead and hood versions are available, with or without fixed covers or with mobile protection covers.
- ❸ Metallic enclosures with a coated finish of epoxy-polyester with high resistance to mechanical stress and external agents. Most of the enclosures reported by using laser marking:
 - the article code
 - the size of the thread of cable entry.
- ❹ Inserts are made of UL certified self-extinguishing fibreglass reinforced thermoplastics, and feature an operating temperature range between -40 °C and +125 °C.
- ❺ Insert profiles polarised with asymmetrical guides to avoid incorrect matings. Inserts have a mechanical life equal to or higher than 200 mating cycles.
- ❻ Inserts are manufactured in compliance with European standard EN 61984 (DIN VDE 0627).
- ❼ Special seal gaskets in vinyl nitrile elastomer, in anti-aging, oil-resistant, fuel-resistant, together with the cable entry devices (not supplied) provide an IP65/IP66 degree of protection for coupled connectors.
- ❽ Levers in galvanized steel or thermoplastic material, guarantee a perfect closure and sealing.
- ❾ Locking device available in two versions, simple (with one lever), or double (with two levers). In metallic enclosures, ILME offers two different types of levers: vertical (JEI®-V) or rotative in thermoplastic material (JEI®-P).
- ❿ Captive insert fastening screws, with anti-slackening spring washer or under-head knurling.
- ⓫ Contact position identified with numbers or codes on both sides of each insert and printed with a laser system or from a die.
- ⓬ Tin plated brass contacts connected to the wires by means of captive screws supplied already slackened, or with spring terminal.
- ⓭ Protective earth terminal with a wide contact surface.

JEI®-P
Thermoplastic
Levers



JEI®-V
Vertical
Closing



T-TYPE
Insulating
Enclosures



JEI®
Rigid
Lever



Dimensioning of clearances and creepage distances

European standard EN 61984 (2009-06) was recently published for safety prescriptions for multipole connectors for industrial uses and for the relevant tests which incorporates without modification the corresponding international standard IEC 61984 Ed EN 2.0 (2008-10).

It is applicable to connectors with rated voltage values of over 50V, and up to 1000V, and rated currents values of up to 125A per pole, for which no dedicated standard exists, or to which the particular specifications or the manufacturer refer as regards the safety aspects. It can be used as a guide for connectors with rated voltage exceeding 125A per pole and those with a rated voltage less than 50V (the latter excluded from the scope of the Low Voltage Directive 2006/95/EC).

The new edition of the EN 61984 standard also introduces the definition of **connector without breaking capacity (COC)** to better distinguish this category of products from **connectors with breaking capacity (CBC)**.

For terminal security and performance requirements, according to the connection technique adopted, the standard now integrally refers to the corresponding standards (IEC/EN 60999 series and IEC/EN 60352 series). For determining the minimum through-air and surface insulation distances, i.e. creepage distances, for connectors, this standard now refers, without any modifications to standard IEC 60664-1 Ed. 2.0 (2007-04)¹⁾.

The following illustrates the method of standard EN 61984, with reference to standard IEC 60664-1, for determining the minimum insulation in connectors. The rated characteristics for each ILME connector family are provided on pages 14 and 15. As in the first edition, the following are now obsolete: the insulation group concept and the distinction of rated voltage values into d.c. and a.c. voltage values 220V and 380V were adapted to standardised values 230V and 400V according to IEC 60038 ⁽²⁾ and some concepts were taken from the regulations for LV electrical systems of the IEC 60364 ⁽³⁾ series, such as:

- the overvoltage categories (I, II, III, IV), according to the use of the equipment ⁽⁴⁾: these are correlated with the transient overvoltages taken as a basis for determining the rated impulse withstand voltage;
- the degrees of pollution
- the classification of insulating materials according to their resistance to tracking
- the conditions of the electrical field (homogenous or npn-homogenous).

Overvoltage categories (or impulse withstand)

The overvoltage categories of a circuit or of an electrical system are identified by a conventional number (from I to IV) based on the limit or the control of the assumed transient overvoltage values obtained on a circuit or electrical system and depends on the means used to reduce the overvoltages.

TABLE 1

The rated impulse withstand voltage for equipment powered directly from the low-voltage mains (IEC 60664-1 Ed. 2.0 2008-10)

Rated supply voltage according to IEC 60038 (CENELEC HD 472 S1, CEI 8-6)		Voltage line to neutral derived from nominal voltages a.c. or d.c.	Rated impulse withstand voltage b)			
V _{Three-phase a)}	V _{Single phase}		Overvoltage category			
		≤ V	I	II	III	IV
		50	330	500	800	1500
		100	500	800	1500	2500
230/400 } 277/480 }	120-240	150	800	1500	2500	4000
		300	1500	2500	4000	6000
400 / 690		600	2500	4000	6000	8000
1000		1000	4000	6000	8000	12000

a) The “/” symbol indicates a four-wire three phase distribution system (star distribution). The lower value is the voltage between phase and neutral (phase voltage), whereas the higher value is the voltage between the phases (mains voltage). Where only one value is indicated, it refers to three-wire, three-phase systems (delta distribution) and specifies the line-to-line value.

b) Equipment with these rated impulse withstand values can be used in installations in accordance with standard IEC 60364-4-443 (Italian standard CEI 64-8/4 Section 443, German DIN VDE 0100-443).

Table 1 supplies the rated impulse withstand voltage for equipment energised directly from the low voltage mains in function of the rated voltage of the power supply system, the relative voltage line-to-neutral and the overvoltage category.

Industrial machinery and installations with fixed connection to the low voltage supply system and consequently the relative components including multipole connectors, constitute an example of the equipment

that belongs to the overvoltage category III.

Examples of general equipment that comes under overvoltage category II are electrical household appliances, portable tools and other household equipment or similar.

For distribution networks with rated voltage of **230/400V** (star distribution with earthed neutral), and over-voltage category III (category III: impulse withstanding), the demanded rated impulse withstanding voltage is **4kV**.

For distribution networks with rated voltage of **400 or 500V** (star distribution without neutral or with insulated neutral, or delta distribution, insulated or corner-earthed), and over-voltage category III (category III: impulse withstanding), the demanded rated impulse withstanding voltage is **6kV**.

Pollution degree

Pollution indicates the presence of any kind of foreign matter, whether solid, liquid or gaseous (ionised gas) that can have a negative influence on the dielectric strength or on the surface resistivity of the insulating material.

The standard establishes four degrees of pollution. The categories are identified by conventional numbers based on the quantity of polluting agents or on the frequency of the phenomenon which determines the reduction of the dielectric strength and/or of the surface resistivity.

Pollution degree 1

No pollution or only dry, non-conductive pollution.

The pollution has no influence.

Pollution degree 2

Only non-conductive pollution except that occasionally a temporary conductivity caused by condensation may occur.

Pollution degree 3

Conductive pollution or dry, non-conductive pollution which becomes conductive due to condensation which may occur.

Pollution degree 4

The pollution generates persistent conductivity caused by conductive dust or by rain or snow.

Pollution degree 3 is typical of an industrial environment or similar, while pollution degree 2 is typical of a household environment or similar.

Standard EN 61984 permits the sizing of surface insulation distances of connectors installed in enclosures in protection class \geq IP54 for the degree of pollution immediately below that of the application environment (e.g.: 2 instead of 3).

Extract from standard EN 61984

6.19.2.2 For a connector in protection rating IP54 or higher, according to Publication IEC 60529, the insulating parts inside the enclosure may be sized for a lower degree of pollution.

This applies also to coupled connectors, closure of which is ensured by the connector enclosure, and which may be uncoupled for test and maintenance purposes only.

One may therefore use connectors installed in enclosures or containers in protection rating \geq IP54, at the rated data referring to degree pollution 2 in industrial applications with degree of pollution 3, if, in compliance with the standard, the coupling of the connectors is opened only occasionally for tests or maintenance. In the event of temporary or limited duration in uncoupled state, a closing cover is, however, necessary, guaranteeing at least protection class IP54. However, this does not apply to connectors which remain uncoupled and exposed to an industrial atmosphere for an indefinite period. It should be noted, however, that pollution could penetrate inside coupled connectors, also when it comes from remote parts of the electrical system (e.g. through conduits providing cable entry to the connectors enclosure). Moreover, connector enclosures are usually supplied without cable entry devices, with the installer fitting such devices according to need. The degree of protection marked on the enclosures is guaranteed only for connectors coupled through the use of cable entry devices in equal or higher IP protection rating and expertly installed.

Examples of application for the selection of degree of pollution 2 for a connector

- connector on an electric motor controller, which is uncoupled only to replace a faulty motor, also in cases where degree of pollution 3 is instead specified for the system;
- connector on a module-constructed machine, which is opened only for transport purposes and which is used only for faster installation and for safer putting into service. One must make sure that the connector has not been polluted during transport. To ensure this has not occurred, protective covers or adequate packing must be used;
- connector inside a panel in protection rating \geq IP54. In this case one may even renounce equipping the connector with an IP54 enclosure.

(1) Assimilated with modifications as European standard EN 60664-1:2007 and published by CENELEC member countries as a national standard: Italian standard CEI EN 60664-1 (class. CEI 109-1) (2008-04), German standard DIN EN 60664-1:2008-01 (VDE 0110-1).

(2) Harmonisation Document CENELEC IEC 60364-4-443 S1, Italian standard CEI 8-6 (1989) + CEI 8-6;V1 (1997), German standard DIN IEC 60038:2002-11.

(3) Italian standard CEI 64-8, German standard DIN VDE 0100.

(4) EN 60664-1 modifies the definition to “impulse withstanding category”.

Insulating material group

Insulating material influences the determination of the minimum creepage distance. It is characterised according to the damage it suffers from the concentrated release of energy during scintillations when a surface leakage current is interrupted due to the drying of the contaminated surface.

The CTI (comparative tracking index, index of resistance to surface currents) is assumed as index of the resistance to creep currents of the insulating materials in the presence of atmospheric contaminating agents (standard IEC/EN 60112).

The CTI constitutes the numeric value of the maximum voltage at which a material can resist against 50 drops of an electrolytic test solution without tracking, i.e. without a progressive formation of conductive paths on the surface of the solid insulating material (and permanent electric arc between the electrodes of the test equipment) due to the combined effect of electrical stress and electrolytic contamination.

Solid insulating materials are classified into four groups:

- group I** 600 ≤ CTI
- group II** 400 ≤ CTI < 600
- group IIIa** 175 ≤ CTI < 400
- group IIIb** 100 ≤ CTI < 175

The values for groups IIIa/IIIb (Tab. F.2, IEC 60664-1) are identical for the purpose of determining the creepage distance values.

The insulating materials used to manufacture the ILME multipole connectors belong to groups IIIa / IIIb.

Electric field conditions

The insulation clearance is determined in Table 2 of IEC 60664-1, bearing in mind the following influencing factors:

- rated impulse withstand voltage
- electric field conditions
- altitude: the values specified in Table 2 are valid up to 2.000 m; for higher altitudes, the corrective factors specified in Table F.8 of IEC 60664-1;
- the micro-environment.

The shape and arrangement of the conductive parts influence the homogeneity of the electric field and consequently the clearance needed to withstand a given voltage.

The clearances in Case A (non-homogeneous field) have the required impulse withstand voltage under all conditions: clearances not less than those specified in **Table F.2 - Case A** can be used irrespective of the shape and arrangement of the conductive parts and without verification by an impulse withstand test.

Determination of clearances

In accordance with standard IEC 60664-1, the following must be identified to determine it:

- a) The rated voltage of the power supply (usually 230/400V and therefore a conventional voltage line-to-neutral of **300V**, in star distribution networks with earthed neutral, or 400V for star networks without neutral, or with insulated neutral, or in networks with the distribution transformer's secondary winding delta connected, insulated or corner-earthed and, therefore, with conventional phase voltage of 600V);
- b) The overvoltage category (usually **III**);
- c) The rated impulse withstand voltage determined from Table 1 of IEC 60664-1 (usually **4 kV** or **6 kV**);
- d) The type of electric field to which the parts through which the current flows shall be subjected (worse case = **inhomogenous field**) and the degree of pollution (usually **3**).

The standard **EN 61984** requires that the **creepage distance** be dimensioned according to IEC 60664-1. For distances up to 2 mm of insulation, typically to connectors for printed circuits, the reference can be, alternatively, standard IEC 60664-5, to be read in conjunction with IEC 60664-1. The minimum through-air insulation distance is therefore given by Table F.2 of IEC 60664-1, according to the rated impulse derived from **Table B.1** of the same standard which is part of Attachment B (informative) Rated voltages of power supply networks for different modes of overvoltage control.

This table is attributable in particular to devices that do not provide any upstream voltage discharge and represents, therefore the "worst case" and replaces **Table 5** of the previous edition of EN 61984.

The rated impulse withstand voltage must be chosen based on the nominal supply voltage and overvoltage category.

The assignment of connectors to a particular overvoltage category (usually **III**) is effected according to the rules of IEC 60664-1.





Rated voltage

Voltage value assigned by the manufacturer to the connector refer to the operating and performance characteristics

NOTE – A connector may have more than one rated voltage value. [IEC 60664-1:2007, definition 3.9, modified]

As concerns the choice of the type of electric field, the through-air insulation distances via windows and openings in the enclosures of insulating material, must comply with the values of case A in Table of IEC 60664-1. i.e. for non uniform field conditions.

TABLE B.1
Intrinsic control or control of equivalent protection (IEC 60664-1 Ed.2.0 (2007-04))

Phase-neutral voltages obtained from AC or DC rated voltages up to and including ⁽¹⁾	Rated voltages currently used throughout the world				Rated impulse withstand voltage for the device ⁽¹⁾			
	Three phase four wire systems neutral earthed 	Three-phase three-wire systems not earthed 	Singl-phase two-wire AC or DC systems 	Singl-phase three-wire AC or DC systems 	Overvoltage category			
	\underline{V}	\underline{V}	\underline{V}	\underline{V}	I	II	III	IV
50			12,5 24 25 30 42 48	30-60	330	500	800	1500
100	66/115	60	60		500	800	1500	2500
150	120/208 ^(*) 127/220	115, 120, 127	100 ^(*) , 110, 120	100-200 ^(*) 110-220 120-240	800	1500	2500	4000
300	220/380, 230/400, 240/415, 260/440, 277/480	200 ^(**) , 220, 230, 240, 260, 277, 347, 380, 400, 415, 440, 480	220	220-440	1500	2500	4000	6000
600	347/600 380/660 400/690 417/720 480/830	500, 577, 600	480	480-960	2500	4000	6000	8000
1000		660 690, 720 830/1000	1000		4000	6000	8000	12000

(1) These columns are taken from Table F.1 indicating the te rated impulse withstand voltages.

(*) Used in the United States and Canada.

(**) Used in Japan.

With the three values (b) (c) and (d) the minimum clearance is determined in Table 2 IEC 60664-1 through-air insulation distance

TABLE F.2*)
Minimum clearance for insulation co-ordination
(IEC 60664-1 Ed.2.0 (2007-04))

Requested impulse withstand voltage ^{(1) (5)}	Minimum clearances up to 2.000 m. above sea level						
	Case A Non-homogeneous field (see 3.15) Pollution degree ⁽⁶⁾			Case B Homogeneous field (see 3.14) Pollution degree ⁽⁶⁾			
	1	2	3	1	2	3	
	mm	mm	mm	mm	mm	mm	
0,33 ⁽²⁾	0,01			0,01			
0,40	0,02		0,02				
0,50 ⁽²⁾	0,04	0,2 ^{(3) (4)}	0,04	0,2 ^{(3) (4)}			
0,60	0,06		0,06		0,06		
0,80 ⁽²⁾	0,10		0,10		0,10		
1,0	0,15		0,15		0,15		0,8 ⁽⁴⁾
1,2	0,25	0,25	0,2				
1,5⁽²⁾	0,5	0,5	0,3	0,3			
2,0	1,0	1,0	0,45	0,45			
2,5 ⁽²⁾	1,5	1,5	0,60	0,60			
3,0	2,0	2,0	0,80	0,80			
4,0⁽²⁾	3,0	3,0	3,0	1,2	1,2	1,2	
5,0	4,0	4,0	4,0	1,5	1,5	1,5	
6,0⁽²⁾	5,5	5,5	5,5	2,0	2,0	2,0	
8,0⁽²⁾	8,0	8,0	8,0	3,0	3,0	3,0	
10	11	11	11	3,5	3,5	3,5	
12⁽²⁾	14	14	14	4,5	4,5	4,5	
15	18	18	18	5,5	5,5	5,5	
20	25	25	25	8,0	8,0	8,0	
25	33	33	33	10	10	10	
30	40	40	40	12,5	12,5	12,5	
40	60	60	60	17	17	17	
50	75	75	75	22	22	22	
60	90	90	90	27	27	27	
80	130	130	130	35	35	35	
100	170	170	170	45	45	45	

- (1) This voltage is
- for functional insulation, at the maximum impulse voltage that can occur at the clearance distance (see 5.1.5),
 - for primary insulation directly exposed or significantly affected by transient overvoltages from the low voltage power supply (see 4.3.3.3, 4.3.3.4.1 and 5.1.6), the rated equipment impulse voltage,
 - for the primary insulations (see 4.3.3.4.2), the maximum impulse voltage that can occur in the circuit.
- For reinforced insulation, see 5.1.6.
- (2) Preferential values specified in 4.2.3 [? table 1].
- (3) For printed circuit material, the values of degree of pollution 1 apply except that the value shall not be less than 0.04 mm as specified in Table F.4
- (4) These minimum clearances given for pollution degrees 2, 3 are based on the reduced resistance characteristics of the corresponding surface insulation distance in wet conditions (see IEC 60664-5).
- (5) For parts or circuits inside equipment subjected to impulse voltages compliant with 4.3.3.4.2, interpolation of values is allowed. However, normalization is achieved using the series of preferred impulse voltage values of 4.2.3.
- (6) The dimensions for degree of pollution 4 are those specified for degree of pollution 3, with the exception that the minimum through-air insulation distance is 1.6 mm.

When the clearance is less than the value indicated for Case A an impulse withstand voltage test certificate is required.

Compared to the previous edition of IEC 60664-1 Table F.2 is has been changed (already with the Variant 2). In particular, the columns referring to degree of pollution 4 have been eliminated. The definition of this degree is varied in 6.2 to: "permanent conductivity occurs, due to conductive dust, rain or other humid conditions". The through-air insulation distances for degree of pollution 4 area as specified for degree of pollution 3, with the exception that the minimum through-air distance is 1.6 mm.

In 6.3 it states that "the size of the surface distances can not be specified in presence of permanent conductive pollution (pollution degree 4).

For temporarily conductive pollution (pollution degree 3) the insulation surface can be designed to avoid the formation of a continuous conductive pollution path, for example using ribs or grooves".

The values in bold are the most common multipole connectors for industrial purposes.

If the component respects the minimum through-air insulation distance prescribed for live parts of opposing polarities, it is exempted from the impulsive voltage withstanding test.

This test is run at sea level using increased voltage values in order to take into account rarefied air at high altitude (the prescribed values refer to 2000 m asl).

However, if this distance is not respected, passing the test gives one the right to declare the relevant rated impulse withstanding voltage.

Declaration of the rated impulse withstanding voltage is optional for standard EN 61984: if the manufacturer declares the rated impulse withstanding voltage, the impulse withstanding voltage test is, in any event, necessary as dielectric verification.

Alternatively, if the manufacturer does not declare this rated value, the voltage withstanding dielectric test at mains frequencies of 50/60 Hz

for 60 s (test 4a of IEC 60512) is necessary, but at reduced values compared to the peak values of the impulsive test voltages of wave shape standardised at 1.2/50 μ s.

To this end, standard EN 61984 provides the following cross-reference table:

TABLE 8
Test voltages (EN 61984 Ed. 2.0 - 2009-06)

Rated impulse withstand voltage U_{ipm} kV	Test voltages Impulse withstand * voltage ^(a) kV (1.2/50 μ s)		Withstand voltage (r.m.s. value) kV (50/60 Hz)
	at 2000 above sea level	at sea level	
	0,5	0,5	
0,8	0,8	0,91	0,50
1,5	1,5	1,75	0,84
2,5	2,5	2,95	1,39
4	4	4,8	2,21
6	6	7,3	3,31
8	8	9,8	4,26
12	12	14,8	6,6

* ^(a) If the test laboratory is situated between sea level and an altitude of 2000 m asl, interpolation of test impulsive voltage is allowed.

NOTE:
This table uses the characteristics of the non-homogeneous field, Case A of IEC 60664-1

Rated impulse withstand voltage

The rated impulse withstanding voltage assigned by the manufacturer to the connector, which refers to the withstanding capacity of its insulation with respect to transient overvoltages [IEC 60664-1:2007, definition 3.9.2, modified].

Impulse withstand voltage

Maximum peak value of a voltage impulse of prescribed shape and polarity which does not cause insulation reduction under specified conditions.

NOTE - The impulse withstand voltage is greater than or equal to the rated impulse withstand voltage [IEC 60664-1:2007, definition 3.8.1, modified].

Determination of creepage distances

For the **minimum surface insulation distance** (creepage distance), i.e. "the shortest distance along the surface of the insulation material between two conducting parts" (IEC 60664-1 definition 3.3) standard IEC 61984:2009 for connectors refers to that prescribed by standard **IEC 60664-1:2007** in **Table F.4**. It is determined according to rated voltage, degree of pollution and insulating material group. The rated voltage providing access to Table 6 (rationalised voltage of the power supply system) is determined by Table 3a of IEC 60664-1 for single phase two or three wire a.c. or d.c. systems or Table 3b for three-phase three or four wire a.c. systems. Usually for three-phase systems with 230V/400V rated voltage, the conventional line-to-line insulation voltage is 400V and the line-to-earth for TT or TN systems is 250V. For three-phase systems with 400V or 500V rated voltage the conventional line-to-line insulation voltage is respectively 400V and 500V.

The degree of pollution must be specified according to standard IEC 60664-1. This strongly influences the rated insulation voltage of a connector. Therefore, the rated insulation voltage of a connector should be reconsidered time by time for each degree of pollution.

TABLE F.3a

Single phase two or three wire a.c. or d.c. systems
(IEC 60664-1 Ed. 2.0 - 2007-04)

Rated supply voltage ¹⁾	Rationalised voltages for Table F.4	
	For insulation phase-phase ¹⁾	For insulation phase-phase ¹⁾
	All systems	Three-wire systems with intermediate earth point
V	V	V
12,5	12,5	-
24	25	-
25	25	-
30	32	-
42	50	-
48	50	-
50 **)	50	-
60	63	-
30-60	63	32
100 **)	100	-
110	125	-
120	125	-
150 **)	160	-
220	250	-
110-220	250	125
120-240	250	125
300 **)	320	-
220-440	500	250
600 **)	630	-
480-960	1000	500
1000 **)	1000	-

TABLE F.3b

Three phase 4 or 3 wire a.c. systems
(IEC 60664-1 Ed. 2.0 - 2007-04)

Rated supply voltage ¹⁾	Rationalised voltages for Table F.4		
	For insulation phase-phase ¹⁾	For insulation phase-phase ¹⁾	
	All systems	Four-wire three-phase systems with earthed neutral	Four-wire three-phase systems unearthed ¹⁾ or with earthed phase
V	V	V	V
63	63	32	63
110	125	80	125
120	125	80	125
127	125	80	125
150 **)	160	-	160
208	200	125	200
220	250	160	250
230	250	160	250
240	250	160	250
300 **)	320	-	320
380	400	250	400
400	400	250	400
415	400	250	400
440	500	250	500
480	500	320	500
500	500	320	500
575	630	400	630
600 **)	630	-	630
660	630	400	630
690	630	400	630
720	800	500	800
830	800	500	800
960	1000	630	1000
1000 **)	1000	-	1000

Legend:

- 1) The phase-earth insulation for unearthed or impedance-earthed lines is equal to that between phases, because the operating voltage of any phase can, in practice, approach full voltage between the phases [line voltage]. This is because the actual voltage to earth is determined by the insulation resistance and by the capacitive reactance of each phase to earth. Consequently, a low (but acceptable) insulation resistance of a phase can, in effect, earth it and increase voltage to earth of the other two phases at full voltage between the phases [line voltage].
- 2) For equipment for use on both three-phase three-wire and three-phase four wire supplies, earthed or unearthed, use only the values for three-wire systems.

*) It is assumed that the rated voltage of the equipment is not less than this value.

***) These values correspond to the values given in Table F.1.

With this voltage value, the pollution degree and the materials group the minimum creepage distance can be determined using **Table 6**.

TABLE F.4

 Creepage distances to avoid failure due to surface currents
 [IEC 60664-1 Ed.2.0 (2007-04)]

Effective voltage ⁽¹⁾	Minimum creepage distances									
	Materials for printed circuits		Pollution degree							
	1	2	1	2		3				
	All material groups	All material groups except IIIb	All material groups	All material groups I	All material groups II	All material groups III	All material groups I	All material groups II	All material groups III ⁽²⁾	
	mm	mm	mm	mm	mm	mm	mm	mm	mm	
10	0,025	0,040	0,080	0,400	0,400	0,400	1,000	1,000	1,000	
12,5	0,025	0,040	0,090	0,420	0,420	0,420	1,050	1,050	1,050	
16	0,025	0,040	0,100	0,450	0,450	0,450	1,100	1,100	1,100	
20	0,025	0,040	0,110	0,480	0,480	0,480	1,200	1,200	1,200	
25	0,025	0,040	0,125	0,500	0,500	0,500	1,250	1,250	1,250	
32	0,025	0,040	0,14	0,53	0,53	0,53	1,30	1,30	1,30	
40	0,025	0,040	0,16	0,56	0,80	1,10	1,40	1,60	1,80	
50	0,025	0,040	0,18	0,60	0,85	1,20	1,50	1,70	1,90	
63	0,040	0,063	0,20	0,63	0,90	1,25	1,60	1,80	2,00	
80	0,063	0,100	0,22	0,67	0,95	1,30	1,70	1,90	2,10	
100	0,100	0,160	0,25	0,71	1,00	1,40	1,80	2,00	2,20	
125	0,160	0,250	0,28	0,75	1,05	1,50	1,90	2,10	2,40	
160	0,250	0,400	0,32	0,80	1,10	1,60	2,00	2,20	2,50	
200	0,400	0,630	0,42	1,00	1,40	2,00	2,50	2,80	3,20	
250	0,560	1,000	0,56	1,25	1,80	2,50	3,20	3,60	4,00	
320	0,75	1,60	0,75	1,60	2,20	3,20	4,00	4,50	5,00	
400	1,0	2,0	1,0	2,0	2,8	4,0	5,0	5,6	6,3	
500	1,3	2,5	1,3	2,5	3,6	5,0	6,3	7,1	8,0	
630	1,8	3,2	1,8	3,2	4,5	6,3	8,0	9,0	10,0	
800	2,4	4,0	2,4	4,0	5,6	8,0	10,0	11,0	12,5	
1 000	3,2	5,0	3,2	5,0	7,1	10,0	12,5	14,0	16,0	
1 250			4,2	6,3	9,0	12,5	(10,2) ⁽⁴⁾	(11,2) ⁽⁴⁾	(12,8) ⁽⁴⁾	
1 600			5,6	8,0	11,0	16,0	(12,8) ⁽⁴⁾	(14,4) ⁽⁴⁾	(16,0) ⁽⁴⁾	
2 000			7,5	10,0	14,0	20,0	(16,0) ⁽⁴⁾	(17,6) ⁽⁴⁾	(20,0) ⁽⁴⁾	
2 500			10,0	12,5	18,0	25,0	(20,0) ⁽⁴⁾	(22,4) ⁽⁴⁾	(25,6) ⁽⁴⁾	
3 200			12,5	16,0	22,0	32,0	(25,6) ⁽⁴⁾	(28,8) ⁽⁴⁾	(32,0) ⁽⁴⁾	
4 000			16,0	20,0	28,0	40,0	(32,0) ⁽⁴⁾	(36,0) ⁽⁴⁾	(40,0) ⁽⁴⁾	
5 000			20,0	25,0	36,0	50,0	(40,0) ⁽⁴⁾	(44,8) ⁽⁴⁾	(50,4) ⁽⁴⁾	
6 300			25,0	32,0	45,0	63,0	(50,4) ⁽⁴⁾	(56,8) ⁽⁴⁾	(64,0) ⁽⁴⁾	
8 000			32,0	40,0	56,0	80,0	(64,0) ⁽⁴⁾	(72,0) ⁽⁴⁾	(80,0) ⁽⁴⁾	
10 000			40,0	50,0	71,0	100,0	(80,0) ⁽⁴⁾	(88,0) ⁽⁴⁾	(100,0) ⁽⁴⁾	
12 500			50,0 ⁽³⁾	63,0 ⁽³⁾	90,0 ⁽³⁾	125,0 ⁽³⁾	(100,0) ⁽⁴⁾	(112,0) ⁽⁴⁾	(128,0) ⁽⁴⁾	
16 000			63,0 ⁽³⁾	80,0 ⁽³⁾	110,0 ⁽³⁾	160,0 ⁽³⁾				
20 000			80,0 ⁽³⁾	100,0 ⁽³⁾	140,0 ⁽³⁾	200,0 ⁽³⁾				
25 000			100,0 ⁽³⁾	125,0 ⁽³⁾	180,0 ⁽³⁾	250,0 ⁽³⁾				
32 000			125,0 ⁽³⁾	160,0 ⁽³⁾	220,0 ⁽³⁾	320,0 ⁽³⁾				
40 000			160,0 ⁽³⁾	200,0 ⁽³⁾	280,0 ⁽³⁾	400,0 ⁽³⁾				
50 000			200,0 ⁽³⁾	250,0 ⁽³⁾	360,0 ⁽³⁾	500,0 ⁽³⁾				
63 000			250,0 ⁽³⁾	320,0 ⁽³⁾	450,0 ⁽³⁾	600,0 ⁽³⁾				

(1) This voltage is:

- for insulation according to the working voltage.
- for main and supplementary insulation of the circuit powered directly by the network (see 4.3.2.2.1), at the rationalized voltage of Table F.3a or Table F.3b, on the basis of the rated voltage of the equipment or rated insulation voltage.
- for main and supplementary insulation of the system, device and internal circuits not powered directly by the network (see 4.3.2.2.2), the highest rms voltage which can occur in the system, in the device or in the internal circuit, powered at rated voltage and in the combination of the most onerous operating conditions foreseen by the rated characteristics of the device.

(2) Materials group IIIb is not recommended for application with pollution degree 3 above 630V.

(3) Provisional data based on extrapolations. Technical committees that have other information based on experience can use their dimensions.

(4) The values shown in brackets may be applied to decrease the creepage distance in the presence of ribbing (see 5.2.5).

NOTE: The high precision used in indicating creepage distances in this table does not mean that the uncertainty of measurement should be of the same order of magnitude.

 NOTE – in **boldface** the typical values for multipole rectangular connectors for industrial uses are shown.

Recommended tightening torque and size of screwdriver

size of screw	connector type	tightening torque (Nm)	tightening torque (lb.in)	recommended size of screwdriver (mm)
M3	JK, JKS, CD 07, CD 08	0,5	4,4	0,5x3
M3	JNE, JDA	0,5	4,4	Ph0 or 0,8x4
M3	screw for fastening to enclosures, all series except T-TYPE	0,5 — 0,8	4,4	Ph1 or 0,8x4
M3	screw for fastening to T-TYPE enclosures	0,5	4,4	Ph1 or 0,8x4
M4	screw of earthing terminal	1,2	10,6	Ph2 or 1,0x5,5

Increasing the tightening torque does not improve considerably the contacts resistances. The screw torques are selected according to standard EN 60999-1, to provide excellent mechanical, thermal and electric behaviour. The conductor or terminal may be damaged if the recommended values are significantly exceeded.

Stripping length

connector inserts	conductor section		stripping length **
	(mm ²)	(AWG)	
connection technique			(mm)
Screw			
JK	0,75-2,5	18-14	6
JNE, JDA	0,5-4	20-12	7 **
Crimp			
CD, CDD	0,14-2,5 *	26-14	8 (* 6 for 2,5 mm ²)
CCE, CQE	0,5-4	20-12	7,5
Spring			
JSE, JSH	0,14-2,5	26-14	9-11
JDS	0,14-2,5	26-14	9-11
JKS	0,14-2,5	26-14	9-11

** The stripping length for prepared wires with bush crimped depends on that of the bush itself.

contacts with screw terminal connections with or without wire protection

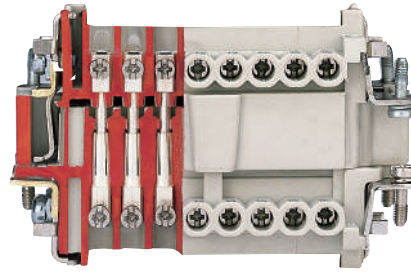

description

The different types of conductor connections to the male and female inserts are described on the right. The types are summarised as follows:

- screw terminals
- spring connection terminals

N.B.:
for all inserts with screw terminals it is important that the right torsional torque is applied to the screws in order to prevent wrong contacts or damage to the conductor, the screw or the terminal (see data mentioned in the inserts pages).

description

inserts: JK - JNE - JDA

The connections of the conductors to the female and male inserts is made via screws (in accordance with standard EN 60999-1).

Two different types of clamping are possible:

- with pressure plate for unprepared conductors
- without wire protection that requires the conductors to be prepared with bush terminals

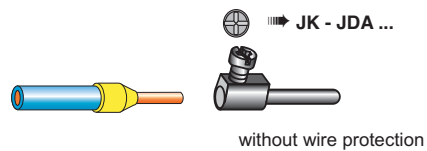
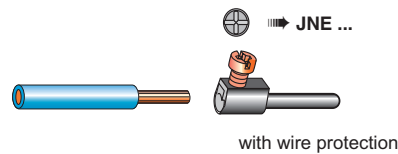

contacts connected with spring terminal



description

inserts: JDS

- In this layout the wires are connected to the socket and plug insert contacts by means of a spring terminal.
- This type of connection offers the following advantages:
- no special wire preparation
 - a screwdriver with a 0,5 x 3,5 mm blade is the only tool required to insert the wire in the contact
 - offers an excellent fastening solution and a great resistance to strong vibrations
 - allows rigid and flexible wires with sections between 0,14 and 2,5 mm² to be used (both with non-prepared conductors and those prepared with ferrule)
 - allows conductivity tests under load to be carried out through the screwdriver insertion section, without splitting the insert
 - greatly reduces insert preparation and cabling times.

contacts connected with spring terminal

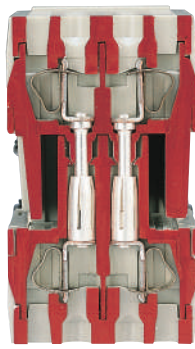

description

inserts: JSE

- In this layout the wires are connected to the socket and plug insert contacts by means of a spring terminal.
- This type of connection offers the following advantages:
- no special wire preparation
 - a screwdriver with a 0,5 x 3,5 mm blade is the only tool required to insert the wire in the contact
 - offers an excellent fastening solution and a great resistance to strong vibrations
 - allows rigid and flexible wires with sections between 0,14 and 2,5 mm² to be used (both with non-prepared conductors and those prepared with ferrule)
 - allows conductivity tests under load to be carried out through the screwdriver insertion section, without splitting the insert
 - greatly reduces insert preparation and cabling times.

spring connected contacts with actuator button

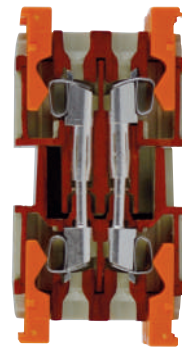

description

inserts: JSH

- In this layout the wires are connected to the socket and plug insert contacts by means of a spring terminal with actuator button.
- This type of connection offers the following advantages:
- no special wire preparation (**other than stripping**)
 - no cabling tool is necessary
 - offers an excellent fastening solution and a great resistance to strong vibrations
 - allows rigid and flexible wires with sections between 0,14 and 2,5 mm² (26 - 14 AWG) to be used (both with non-prepared conductors and those prepared with ferrule)
 - greatly reduces insert preparation and cabling times
 - a screwdriver with a 0,5 x 3,5 mm blade is the only tool required to remove the wire from the contact.

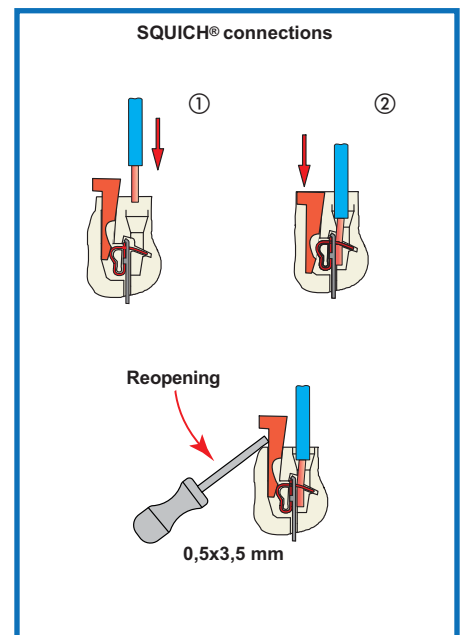
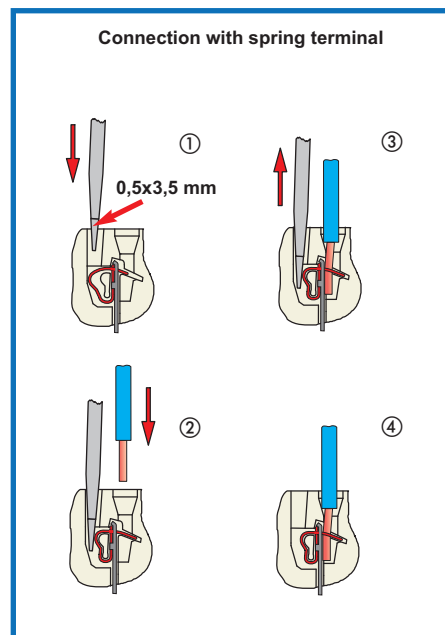
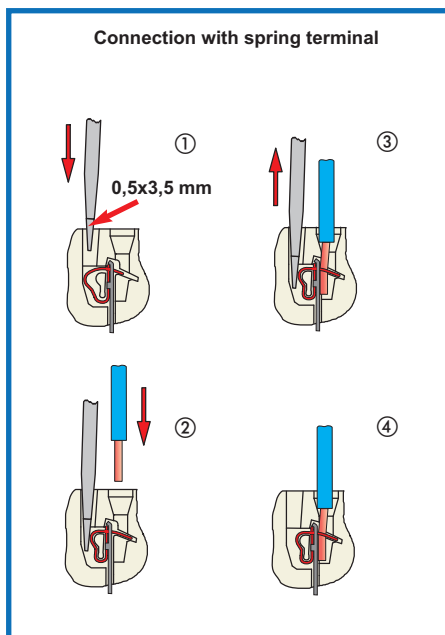

enclosures size	enclosure versions					insert series						
	JEI-P pages	JEI-V pages	T-TYPE pages	COB pages	CK - CKA pages	JK, JKS	CD	CDD	JDS	JDA	CQE	JSH, JNE JSE, CCE
						insert polarity + ⊕						
21.21	X	X	X	X	✓ 123 - 127	3 4	7 8#					
49.16	✓ 88 - 89	X	X	✓ 145	X		15			10		
66.16	✓ 90 - 91	X	X	✓ 145	X		25	38		16		
44.27	✓ 92 - 93	✓ 102 - 104	✓ 134 - 135	✓ 143 - 144	X			24	9		10	6
57.27	✓ 94 - 95	✓ 105 - 109	✓ 136 - 137	✓ 143 - 144	X			42	18		18	10
77.27	✓ 96 - 97	✓ 110 - 114	✓ 138 - 139	✓ 143 - 144	X		40	72	27		32	16
104.27	✓ 98 - 99	✓ 115 - 119	✓ 140 - 141	✓ 143 - 144	X		64	108	42		46	24
77.62	✓ 100 - 101	✓ 120 - 121	X	X	X		80	144	54		64	32
104.62	X	✓ 122	X	X	X		128	216	84		92	48

✓ = normal production
 X = currently unavailable

= polarity without earth contact

The polarity values in "red" are obtained using double inserts.

Changeover from Pg threads to M metric threads

After 31st December 1999, the German safety standard DIN VDE 0619 (1987-09) and the standards it refers to - DIN 46319 for dimensions with metric threads and DIN 46320 (T1-T4), DIN 46255 and DIN 46259 for dimensions with Pg threads (Pg= Panzerrohr-Gewinde: literally "threads for armoured pipes") - were withdrawn and European standard EN 50262 "Metric cable grippers for electrical installations" has been in force since 1st January 2000.

This standard defines the new sizes with metric threads for cable grippers according to EN 60423 and establishes the safety prescriptions.

Conversely, it does not specify the dimensions, such as the size of the tightening wrench, the diagonal dimension, or the dimensions of the tightness seals, as was the case in the withdrawn DIN for Pg cable grippers.

The standard came definitively into force on 1st April 2001, when the contrasting national standards were withdrawn.

It is valid in all member countries of CENELEC (European Electrical Standardisation Committee) and its publication has led to a broadening of the supply of enclosures for multi-pole connectors for industrial use, to include new enclosure versions with cable entry suitable for metric cable grippers.

Cable gripper producers have introduced the new metric series to add to the Pg size series, to gradually replace the latter type.

The transition period indicated in the new standard should have ended on 1st March 2001, after which date the use of entry devices for Pg cables and, as a result, enclosures with Pg thread, should have ended in new installations.

Nevertheless, both the cable entry devices and the relevant enclosures with Pg thread, may continue to be used as spare parts.

For the CE marking of these items, observance of the safety conditions specified by the Low Voltage Directive is sufficient.

To distinguish hoods and surface-mounting housings with metric entries from the relevant Pg versions (marked with a C pre-code), the ILME metric types are marked with an M pre-code.

The transposition table below indicates the correspondence rule adopted in most cases by ILME for creating the new metric versions.

Pg → metric transposition

Pg	metric
Pg 11	M 20
Pg 13.5	M 20
Pg 16	M 20
Pg 21	M 25
Pg 29	M 32
Pg 36	M 40
Pg 42	M 50

Cable diameter for use with ILME cable glands (for more information ask for the technical catalogue)

serie	metric thread				
	20	25	32	40	50
AS M..P	from 6 to 12,5	from 10 to 18	from 14 to 24	from 15 to 24	from 23 to 30
AS M..E	from 8 to 12,5	from 13,5 to 18	from 17 to 24		
AG M..T	6-8-10	11-14-17	19-21-24	26-29-32	35-38-41
AG M..I	from 5 to 12,5	from 9 to 18	from 14 to 25	from 18 to 32	from 24 to 38,5
AG M..R	6-8-10	11-14-17	19-21-24		

IP degree of protection and the EN 60529 standard

The minimum IP degree of protection is regulated by the CEI 64-8 installation standards (inclusion of the harmonisation documents of the CENELEC HD 384 series and the IEC 60364 publication) which, in part 7, cover a number of special environments: construction and demolition sites, structures designed for agricultural or livestock breeding use, restricted conductor areas, caravans and caravan sites, environments with a greater risk in case of fire, public performance and entertainment areas, pools and, in the future, fountains and marinas and harbour areas. The standard is applicable to enclosures for electric materials with a rated power no greater than 72.5 kW.

All the equipment must be installed according to the rule of art and must comply with any manufacturer's assembly instructions. When components of different degrees of protection are assembled, the resulting board or distribution system will assume the lowest degree of protection of the mounted components.

The range of ILME enclosures presented in this catalogue offers the following range of protection:

IP44: protection against the *penetration of solid foreign objects* with a diameter equal to or greater than 1 mm and for protection against the intrusion of dangerous parts with an access calibre of Ø 1 mm (1st digit), and protected against the *dangerous effects of water spray* from all directions (2nd digit).

IP55: protection against the *penetration of solid foreign objects* with a diameter equal to or greater than 1 mm and for protection against the *intrusion of dangerous parts* with an access calibre of Ø 1 mm (1st digit), and protected against the *dangerous effects of water spray* from all directions (2nd digit).

IP66: total protection against *dust* and access to *dangerous parts* with an accessibility calibre of Ø 1 mm (1st digit), and protected against *powerful water jets* such as sea waves (2nd digit).

IP67: total protection against *dust*, and from *access to harmful parts* with accessibility of Ø 1 mm (1st digit), and protection against the *effects of prolonged submersion* (30') in water at the maximum depth of 1 m (2nd digit)¹⁾.

IP69: total protection against dust, and from access to harmful parts with accessibility of Ø 1 mm (1st digit), and protection against water jets high pressure and high temperature (2nd digit).

These enclosure have also successfully passed the tests required for the IPX6 protection rating compliant with EN 60529 standard and for the IPX9K protection rating compliant with DIN 40050-9 standard.

The following table shows the different levels of protection required by the IP standard.

First Digit

Protection of people against contact with harmful parts

IP	Solid external objects	Protection
0		none
1		against solid objects with Ø over 50 mm (e.g. contact with hand)
2		against solid objects with Ø over 12 mm (e.g. contact with finger)
3		against solid objects with Ø over 2,5 mm (e.g. tools and wires)
4		against solid objects with Ø over 1 mm (e.g. fine tools and wires)
5		against dust (no harmful deposit)
6		total against dust

Second Digit

Protection of materials against harmful penetration of water

IP	Tests	Protection
0		none
1		against vertical drops of water
2		against drops of water with an inclination of 15° from the vertical
3		against drops of water with an inclination of 60° from the vertical
4		against splashing water from all directions
5		against water jets from all directions
6		against powerful water jets similar to sea waves
7		against the effects of temporary immersion o a maximum depth of 1 meter
8		against the effects of prolonged submersion in water (duration and / or depth according to agreements)
9		against water jets high pressure and high temperature

¹⁾ The **IP66/IP67** degree of protection will officially be introduced in the next amendment 1 of the standards IEC EN 60309-1 and IEC EN 60309-2 (and of the relating IEC standards). It is already accounted for in the IP degree of protection standard EN 60529 as a "versatile" form of protection, covering the fact that the temporary immersion resistance test (protection IPX7) does not automatically comply with the two lower degrees of protection IPX6 and IPX5, tested with the respective jet tests. If the end user requires the equipment to resist both against temporary immersions and pressurized water jets, declaredly IP66/IP67 devices with double marking must be selected.

JEI®-P version



description

JP series

- made of die cast aluminium alloy
- with epoxy-polyester powder coating
- gaskets in anti-aging, oil-resistant, grease-resistant and fuel-resistant vinyl nitrile elastomer
- locking device with levers in self-extinguishing thermoplastic material
- degree of protection for coupled connectors is **IP65** (according to norm IEC/EN 60529).

JEI®-V version



description

JCV and JMV series

- made of die cast aluminium alloy
- with epoxy-polyester powder coating
- gaskets in anti-aging, oil-resistant, grease-resistant and fuel-resistant vinyl nitrile elastomer
- locking device with levers in galvanized steel.

The tight seal after closure and the simplicity of the movement.

- **The lever occupies a very small space** during the closing phase.
- **It is recommended** in cases in which the **weight of the cable** tends to open elastic levers, like those with vertically installed connectors and cable exits in the bottom.

OPEN

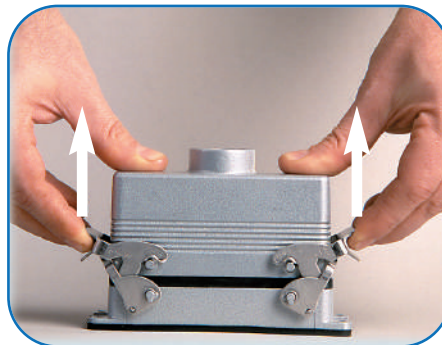

CLOSE

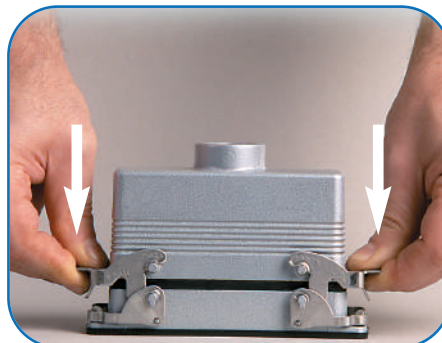

JEI®-V version



description

JCH series JMH series

- made of die cast aluminium alloy
- with epoxy-polyester powder coating
- gaskets in anti-aging, oil-resistant, grease-resistant and fuel-resistant vinyl nitrile elastomer
- locking device with levers in galvanized steel.

CK / CKA standard version



description

CK and MK series

- in self- extinguishing thermoplastic material gray RAL 7035
- gaskets in anti-aging, oil-resistant, grease-resistant and fuel-resistant vinyl nitrile elastomer
- monoblock locking device in self- extinguishing thermoplastic material
- cable entry Pg (CK) or metric (MK)

CKA and MKA series

- made of die cast zinc alloy
- with epoxy-polyester powder coating
- gaskets in anti-aging, oil-resistant, grease-resistant and fuel-resistant vinyl nitrile elastomer
- monoblock locking device in galvanised steel
- cable entry Pg (CKA) or metric (MKA)

T-TYPE version



description

T-TYPE series

- **significant structural solidity** and mechanical robustness by virtue of **substantial thickness**;
- **resistance to the main chemical agents**, found in industrial environments;
- **pre-fastened gaskets** for easier installation;
- **external dimensions** of the bulkhead housing are **similar to those of the corresponding metal enclosures**; hole fixing centres are **unchanged**.
- **ample space** inside enclosures for cables, with mounted connectors, similar to the corresponding metal high construction versions;
- possibility of making completely **insulated constructions** (equivalent to Class II);
- **absence of powder paint** for environments in which these are not recommended;
- **non-electrostatic** thermoplastic material.
- degree of protection for coupled connectors is **IP65** (according to norm **IEC/EN 60529**);
- **UL Type 12** (= NEMA 12) degree of protection according to American standards **ANSI/UL 50** for indoor use;
- each enclosure carries its own part number and conformity markings;
- ambient temperature range: -40 °C / +90 °C.

COB



description

COB series

The COB system makes it possible to use multipole connectors within electric panels without the traditional metallic enclosure as protection is assured by the electric panel itself or other container.

The COB system may be assembled in the three following ways:

- on panels with window snap fastening device
- on DIN EN 60715 rails, both lengthways and crossways to the support
- on fixed panels using screws.

The COB system offers the following advantages:

- reduction in cost and space with respect to metallic enclosures and traditional terminal boards
- possibility of rewiring at the connector bench with connected devices
- easy wiring inspection and tests with coupled connectors, thanks to rear access to the inserts via the turnover device
- fast mounting in panels thanks to the snap fastening device on the DIN EN 60715 rails
- sturdy support structure, specific to the size of each insert and does not require any preparation
- broad passage for housing of conductor cables
- mobile parts prearranged for the clamping of bundles of conductors of multipolar cables to prevent contact with the connector contacts.

plain coding pins
for JK / JKS 03 inserts



plain coding pins
for JK / JKS 04 inserts



description	part No.	
	coding pins for JK/JKS 03 inserts	CR K03
coding pins for JK/JKS 04 inserts	red CR K04R	yellow CR K04G

Code pins

Each series of connector inserts is made in such a way as to make incorrect coupling between inserts of different series impossible.

When a number of identical connectors with different functions are mounted closely together these must be selected in such a way as to prevent the coupling of a mobile part on a non-corresponding fixed part and consequent damage and breakdown.

Within this scope, special coding pins have been manufactured in order to restrict or avoid mating identical multiple connectors differently encoded.

dimensions in mm

CR K03

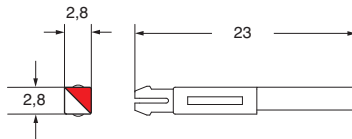

dimensions in mm

CR K04R

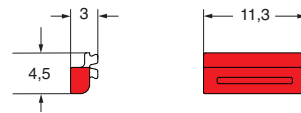

CR K04G

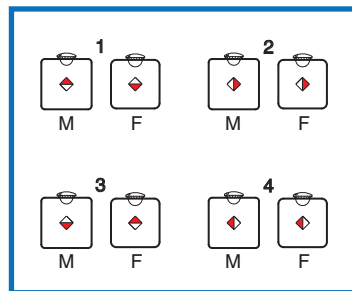
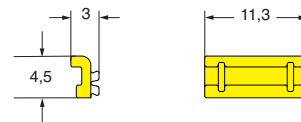

M = male insert
F = female insert

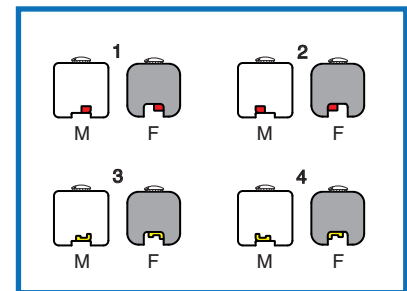

M = male insert
F = female insert

dimensions shown are not binding
and may be changed without notice

enclosures:

size "21.21"

page:

insulating CK 123 - 124

metallic CKA 125 - 127

- can be mated with JKS inserts

**inserts, 3 poles + ⊕
screw terminal connections**



tin plated contacts

**inserts, 4 poles + ⊕
screw terminal connections**



tin plated contacts

description	part No.	part No.
female inserts with female contacts ¹⁾ male inserts with male contacts	JKF 03 JKM 03	
female inserts with female contacts ¹⁾ male inserts with male contacts		JKF 04 JKM 04

¹⁾ the female inserts can be mounted into the straight bulkhead housings CK I from the rear

dimensions in mm

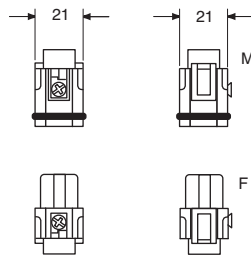

dimensions in mm

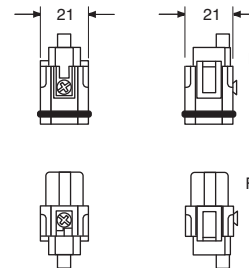

- characteristics according to EN 61984:

- 10A 230/400V 4kV 3**
- certifications: UL, EAC
- insulation resistance: ≥ 10 GΩ
- ambient temperature limit: -40 °C ... +100 °C
- are made of self-extinguishing thermoplastic resin UL 94 V1
- mechanical life: ≥ 200 cycles
- contact resistance: ≤ 1 mΩ
- for maximum current load, see the following load curves inserts

contacts side (front view)

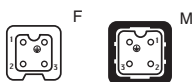

contacts side (front view)

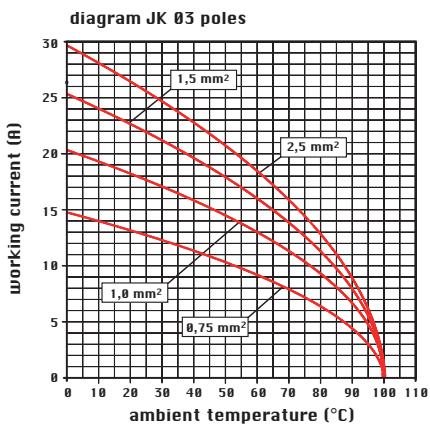
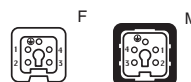

- inserts for connectors with the following sections: 0,75 - 2,5 mm² - AWG 18 - 14
- conductors stripping length: 6 mm
- terminal screw torque: 0,5 Nm, size screwdriver recommended: 0,5x3 mm for more information see page 19

- inserts for connectors with the following sections: 0,75 - 2,5 mm² - AWG 18 - 14
- conductors stripping length: 6 mm
- terminal screw torque: 0,5 Nm, size screwdriver recommended: 0,5x3 mm for more information see page 19

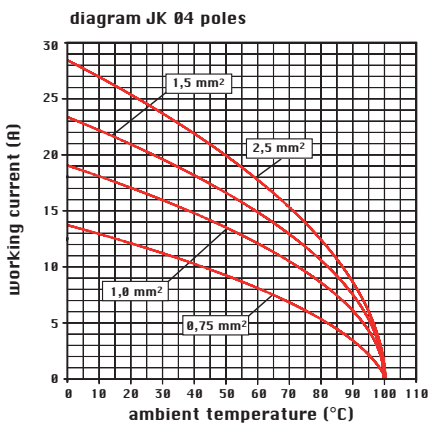

coding pins optional CR K03 (page 26)



coding pins optional CR K04R/CR K04G (page 26)



dimensions shown are not binding and may be changed without notice

contacts connected with spring terminal

description
inserts: JKS

In this layout the wires are connected to the socket and plug insert contacts by means of a spring terminal. This type of connection offers the following advantages:

- no special wire preparation
- a screwdriver with a 0,5 x 3,5 mm blade is the only tool required to insert the wire in the contact
- offers an excellent fastening solution and a great resistance to strong vibrations
- allows rigid and flexible wires with sections between 0,14 and 2,5 mm² to be used (both with non-prepared conductors and those prepared with ferrule)
- allows conductivity tests under load to be carried out through the screwdriver insertion section, without splitting the insert
- greatly reduces insert preparation and cabling times.

inserts series		JKS
No. of poles	main contacts + ⊕	3, 4
	auxiliary contacts	--
rated current ¹⁾		10A
EN 61984 pollution degree 3	rated voltage	400V
	rated impulse withstand voltage	4kV
	pollution degree	3
contact resistance		≤ 1 mΩ
insulation resistance		≥ 10 GΩ
ambient temperature limit (°C)	min	-40
	max	+125
degree of protection	with enclosures	IP44, IP66, IP67, IP69K (according to type)
	without enclosures	IP20
conductor connections		spring
conductor cross-section	mm ²	0,14 - 2,5 (for wires with crimped ferrule, usable section: up to 1,5 mm ² (AWG 16))
	AWG	26 - 14
mechanical endurance (rating cycles)		≥ 200

1) Please check the insert load curves to establish the actual maximum operating current according to the ambient temperature.

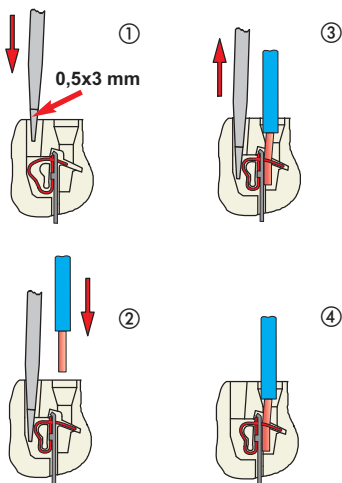
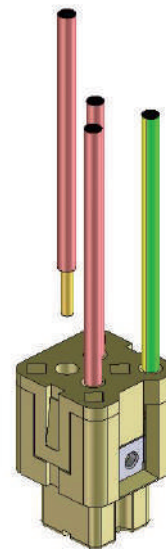
Connection with spring terminal

Rear top entry of wires for a more easier wiring

enclosures:

size "21.21"

page:

insulating CK 123 - 124

metallic CKA 125 - 127

- can be mated with JK inserts

**inserts, 3 poles + ⊕
connection with spring terminal**

 tin plated
contacts

**inserts, 4 poles + ⊕
connection with spring terminal**

 tin plated
contacts

description

part No.

part No.

female inserts with female contacts

male inserts with male contacts

JKSF 03
JKSM 03

female inserts with female contacts

male inserts with male contacts

JKSF 04
JKSM 04

- characteristics according to EN 61984:

10A 400V 4kV 3

- certifications: cUL (UL for USA and Canada), EAC

 - insulation resistance: $\geq 10 \text{ G}\Omega$

 - ambient temperature limit: $-40 \text{ }^\circ\text{C} \dots +125 \text{ }^\circ\text{C}$

- are made of self-extinguishing thermoplastic resin UL 94 V0

 - mechanical life: ≥ 200 cycles

 - contact resistance: $\leq 1 \text{ m}\Omega$

 - for maximum current load, see the following load curves
inserts

dimensions in mm

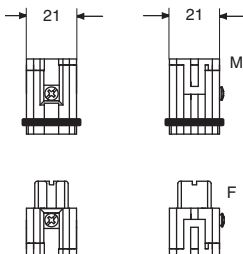

dimensions in mm

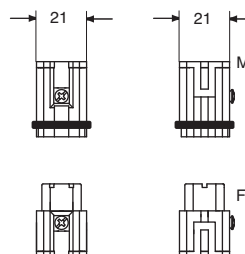

diagram JKS 03 poles

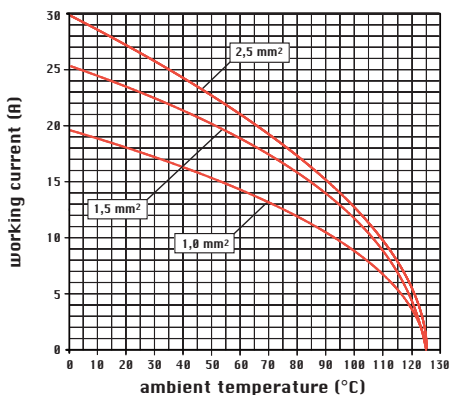
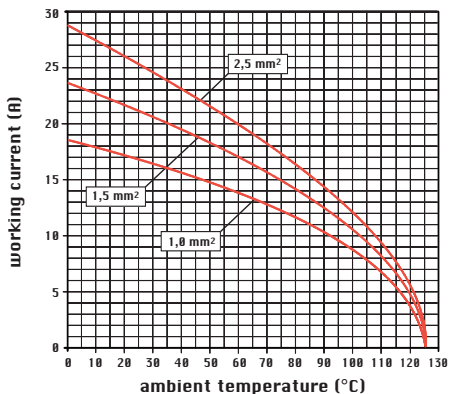
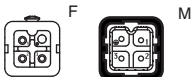

diagram JKS 04 poles



contacts side (front view)



contacts side (front view)

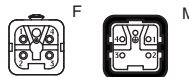

- inserts for wires with the following sections:

 0,14 - 2,5 mm² - AWG 26 - 14

for prepared wires with crimped bush,

 usable section: up to 1,5 mm² (AWG 16)

- conductors stripping length: 9...11 mm *

- size screwdriver recommended: 0,5x3 mm

- inserts for wires with the following sections:

 0,14 - 2,5 mm² - AWG 26 - 14

for prepared wires with crimped bush,

 usable section: up to 1,5 mm² (AWG 16)

- conductors stripping length: 9...11 mm *

- size screwdriver recommended: 0,5x3 mm

* the stripping length for prepared wires with bush

crimped depends on that of the bush itself

* the stripping length for prepared wires with bush

crimped depends on that of the bush itself

coding pins optional CR K03 (page 26)



coding pins optional CR K04R/CR K04G (page 26)

 dimensions shown are not binding
and may be changed without notice

If all the contacts are used, the CD inserts series connectors may be used with voltages of up to 250V (first column) pollution degree 3 in accordance with the standard EN 61984.
 If the number of contacts is reduced and the contacts accordingly assigned, these connectors may be used with higher voltages. This is possible because the decrease in the number of contacts leads to an increase in the surface distance in the air. When the contacts are arranged as shown below, the inserts may be used for voltages of 500V (second column) pollution degree 3 in accordance with the standard EN 61984.

Legend:

- working contact
- without contact
- M = male insert
- F = female insert

for use up to 250V
 pollution degree 3

diagrams
 contacts side (front view)

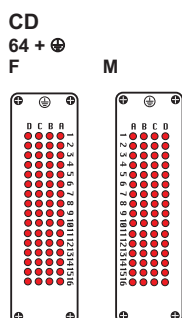
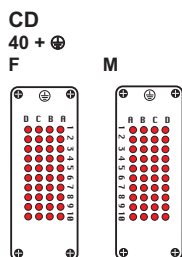
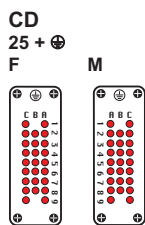
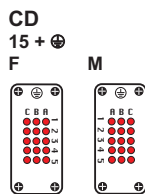
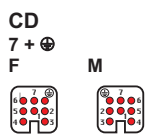

for use up to 500V
 pollution degree 3

diagrams
 contacts side (front view)

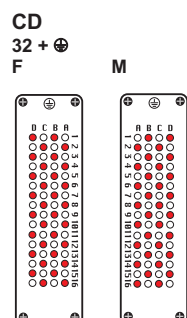
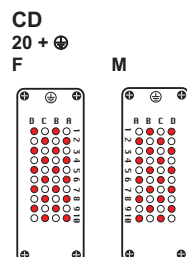
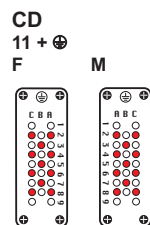
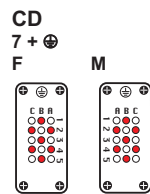
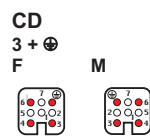

enclosures:

size "21.21"

page:

insulating type 123 - 124

inserts, crimp connections



**10A crimp contacts
tin and gold plated**



description

part No.

part No.

part No.

part No.

without contacts (to be ordered separately)
female inserts for female contacts, grey and black ¹⁾
male inserts for male contacts, grey and black

grey
CDF 07
CDM 07

black
CDF 07 N
CDM 07 N

10A female contacts

0,14-0,37 mm ²	AWG 26-22	identification No. 1
0,5 mm ²	AWG 20	identification No. 2
0,75 mm ²	AWG 18	identification No. ②
1 mm ²	AWG 18	identification No. 3
1,5 mm ²	AWG 16	identification No. 4
2,5 mm ²	AWG 14	identification No. 5

10A male contacts

0,14-0,37 mm ²	AWG 26-22	identification No. 1
0,5 mm ²	AWG 20	identification No. 2
0,75 mm ²	AWG 18	identification No. ②
1 mm ²	AWG 18	identification No. 3
1,5 mm ²	AWG 16	identification No. 4
2,5 mm ²	AWG 14	identification No. 5

CDFS 0.3
CDFS 0.5
CDFS 0.7
CDFS 1.0
CDFS 1.5
CDFS 2.5

tin plated

CDFJD 0.3
CDFJD 0.5
CDFJD 0.7
CDFJD 1.0
CDFJD 1.5
CDFJD 2.5

gold plated

CDMS 0.3
CDMS 0.5
CDMS 0.7
CDMS 1.0
CDMS 1.5
CDMS 2.5

CDMJD 0.3
CDMJD 0.5
CDMJD 0.7
CDMJD 1.0
CDMJD 1.5
CDMJD 2.5

¹⁾ the female inserts can be mounted into the straight bulkhead housings CK I from the rear

- characteristics according to EN 61984:

10A 250V 4kV 3
10A 230/400V 4kV 2

- insulation resistance: ≥ 10 GΩ
- ambient temperature limit: -40 °C ... +125 °C
- are made of self-extinguishing thermoplastic resin UL 94 V0
- mechanical life: ≥ 200 cycles (tin plated)
- mechanical life: ≥ 500 cycles (gold plated)
- contact resistance: ≤ 3 mΩ
- for applications requiring higher voltages, please see the special voltage application section on page 30
- for contact crimping instructions, please see the crimping tool section (10A contacts, CDF and CDM series) on page 150
- for maximum current load, see the following load curves inserts, for more information see page 154

dimensions in mm

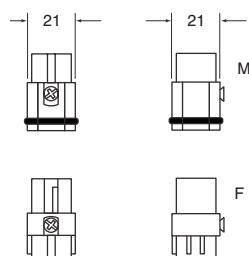

contacts side (front view)



coding pin with loss of a contact CR CP



dimensions in mm

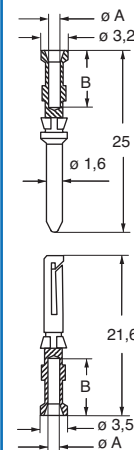
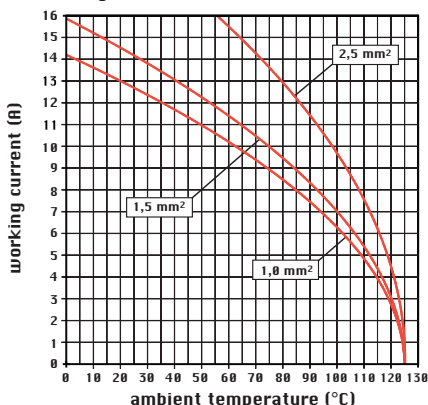

diagram CD 07 poles



dimensions shown are not binding
and may be changed without notice

CDF and CDM contacts

conductor section mm ²	conductor slot ø A (mm)	conductors stripping length B (mm)
0,14-0,37	0,9	8
0,5	1,1	8
0,75	1,3	8
1,0	1,45	8
1,5	1,8	8
2,5	2,2	6

WARNING:

Do not use tin plated crimp contacts coupled with gold plated crimp contacts.

enclosures:

size "21.21"

page:

insulating type 123 - 124

metallic type 125 - 127

inserts, crimp connections



10A crimp contacts tin and gold plated



description

part No.

part No.

part No.

without contacts (to be ordered separately)
female inserts for female contacts ¹⁾
male inserts for male contacts

CDF 08
CDM 08

10A female contacts

0,14-0,37 mm ²	AWG 26-22	identification No. 1
0,5 mm ²	AWG 20	identification No. 2
0,75 mm ²	AWG 18	identification No. ②
1 mm ²	AWG 18	identification No. 3
1,5 mm ²	AWG 16	identification No. 4
2,5 mm ²	AWG 14	identification No. 5

10A male contacts

0,14-0,37 mm ²	AWG 26-22	identification No. 1
0,5 mm ²	AWG 20	identification No. 2
0,75 mm ²	AWG 18	identification No. ②
1 mm ²	AWG 18	identification No. 3
1,5 mm ²	AWG 16	identification No. 4
2,5 mm ²	AWG 14	identification No. 5

CDFS 0.3
CDFS 0.5
CDFS 0.7
CDFS 1.0
CDFS 1.5
CDFS 2.5

tin plated

CDFJD 0.3
CDFJD 0.5
CDFJD 0.7
CDFJD 1.0
CDFJD 1.5
CDFJD 2.5

gold plated

CDMS 0.3
CDMS 0.5
CDMS 0.7
CDMS 1.0
CDMS 1.5
CDMS 2.5

CDMJD 0.3
CDMJD 0.5
CDMJD 0.7
CDMJD 1.0
CDMJD 1.5
CDMJD 2.5

¹⁾ the female inserts can be mounted into the straight bulkhead housings CK I from the rear

dimensions in mm

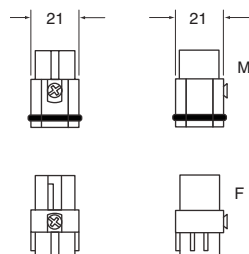

dimensions in mm

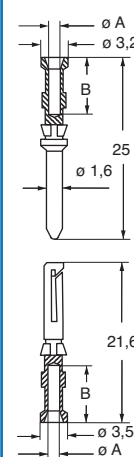

- characteristics according to EN 61984:

10A 50V 0,8kV 3

- rated voltage according to UL/CSA: 50V
- insulation resistance: ≥ 10 GΩ
- ambient temperature limit: -40 °C ... +125 °C
- are made of self-extinguishing thermoplastic resin UL 94 V0
- mechanical life: ≥ 200 cycles (tin plated)
- mechanical life: ≥ 500 cycles (gold plated)
- contact resistance: ≤ 3 mΩ
- for contact crimping instructions, please see the crimping tool section (10A contacts, CDF and CDM series) on page 150
- for maximum current load, see the following load curves inserts, for more information see page 154

contacts side (front view)

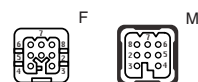

coding pin with loss of a contact CR CP

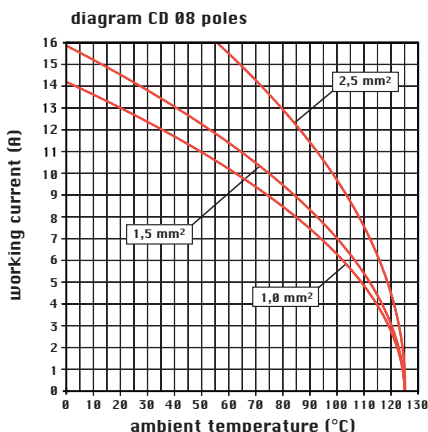

dimensions shown are not binding and may be changed without notice

CDF and CDM contacts

conductor section mm ²	conductor slot ø A (mm)	conductors stripping length B (mm)
0,14-0,37	0,9	8
0,5	1,1	8
0,75	1,3	8
1,0	1,45	8
1,5	1,8	8
2,5	2,2	6

WARNING:

Do not use tin plated crimp contacts coupled with gold plated crimp contacts.

enclosures:

size "49.16"

page:

JEI®-P thermoplastic lever 88 - 89

panel supports:

page:

COB + adaptor 143 - 145

inserts, crimp connections

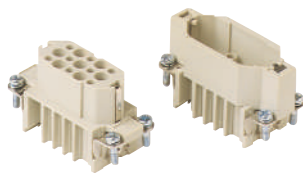

**10A crimp contacts
tin and gold plated**



description

part No.

part No.

part No.

without contacts (to be ordered separately)
female inserts for female contacts
male inserts for male contacts

CDF 15
CDM 15

10A female contacts

0,14-0,37 mm ²	AWG 26-22	identification No. 1
0,5 mm ²	AWG 20	identification No. 2
0,75 mm ²	AWG 18	identification No. ②
1 mm ²	AWG 18	identification No. 3
1,5 mm ²	AWG 16	identification No. 4
2,5 mm ²	AWG 14	identification No. 5

10A male contacts

0,14-0,37 mm ²	AWG 26-22	identification No. 1
0,5 mm ²	AWG 20	identification No. 2
0,75 mm ²	AWG 18	identification No. ②
1 mm ²	AWG 18	identification No. 3
1,5 mm ²	AWG 16	identification No. 4
2,5 mm ²	AWG 14	identification No. 5

CDFS 0.3
CDFS 0.5
CDFS 0.7
CDFS 1.0
CDFS 1.5
CDFS 2.5

tin plated

CDFJD 0.3
CDFJD 0.5
CDFJD 0.7
CDFJD 1.0
CDFJD 1.5
CDFJD 2.5

gold plated

CDMS 0.3
CDMS 0.5
CDMS 0.7
CDMS 1.0
CDMS 1.5
CDMS 2.5

CDMJD 0.3
CDMJD 0.5
CDMJD 0.7
CDMJD 1.0
CDMJD 1.5
CDMJD 2.5

- characteristics according to EN 61984:

10A 250V 4kV 3
10A 230/400V 4kV 2

- compliant with DIN EN 175 301-801 standard
- rated voltage according to UL/CSA: 600V
- insulation resistance: ≥ 10 GΩ
- ambient temperature limit: -40 °C ... +125 °C
- are made of self-extinguishing thermoplastic resin UL 94 V0
- mechanical life: ≥ 200 cycles (tin plated)
- mechanical life: ≥ 500 cycles (gold plated)
- contact resistance: ≤ 3 mΩ
- for applications requiring higher voltages, please see the special voltage application section on page 30
- for contact crimping instructions, please see the crimping tool section (10A contacts, CDF and CDM series) on page 150
- for maximum current load, see the following load curves inserts, for more information see page 154

dimensions in mm

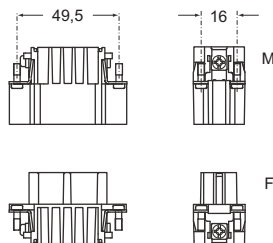

contacts side (front view)

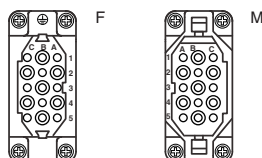

dimensions in mm

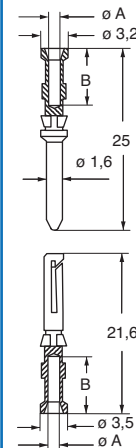
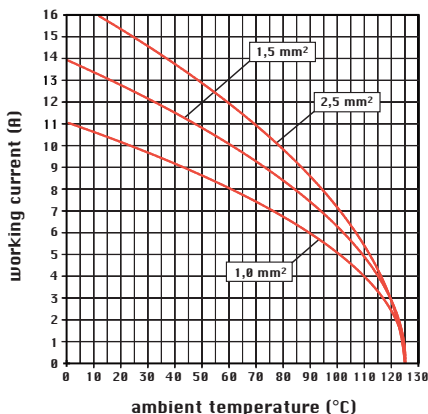

diagram CD 15 poles



dimensions shown are not binding
and may be changed without notice

CDF and CDM contacts

conductor section mm ²	conductor slot ø A (mm)	conductors stripping length B (mm)
0,14-0,37	0,9	8
0,5	1,1	8
0,75	1,3	8
1,0	1,45	8
1,5	1,8	8
2,5	2,2	6

WARNING:

Do not use tin plated crimp contacts coupled with gold plated crimp contacts.

enclosures:

size "66.16"

page:

JEI®-P thermoplastic lever 90 - 91

panel supports:

page:

COB + adaptor 143 - 145

inserts, crimp connections

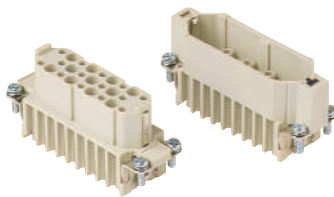

**10A crimp contacts
tin and gold plated**



description

part No.

part No.

part No.

without contacts (to be ordered separately)
female inserts for female contacts
male inserts for male contacts

CDF 25
CDM 25

10A female contacts

0,14-0,37 mm ²	AWG 26-22	identification No. 1
0,5 mm ²	AWG 20	identification No. 2
0,75 mm ²	AWG 18	identification No. ②
1 mm ²	AWG 18	identification No. 3
1,5 mm ²	AWG 16	identification No. 4
2,5 mm ²	AWG 14	identification No. 5

10A male contacts

0,14-0,37 mm ²	AWG 26-22	identification No. 1
0,5 mm ²	AWG 20	identification No. 2
0,75 mm ²	AWG 18	identification No. ②
1 mm ²	AWG 18	identification No. 3
1,5 mm ²	AWG 16	identification No. 4
2,5 mm ²	AWG 14	identification No. 5

CDFS 0.3
CDFS 0.5
CDFS 0.7
CDFS 1.0
CDFS 1.5
CDFS 2.5

tin plated

CDFJD 0.3
CDFJD 0.5
CDFJD 0.7
CDFJD 1.0
CDFJD 1.5
CDFJD 2.5

gold plated

CDMS 0.3
CDMS 0.5
CDMS 0.7
CDMS 1.0
CDMS 1.5
CDMS 2.5

CDMJD 0.3
CDMJD 0.5
CDMJD 0.7
CDMJD 1.0
CDMJD 1.5
CDMJD 2.5

- characteristics according to EN 61984:

10A 250V 4kV 3
10A 230/400V 4kV 2

- compliant with DIN EN 175 301-801 standard
- rated voltage according to UL/CSA: 600V
- insulation resistance: ≥ 10 GΩ
- ambient temperature limit: -40 °C ... +125 °C
- are made of self-extinguishing thermoplastic resin UL 94 V0
- mechanical life: ≥ 200 cycles (tin plated)
- mechanical life: ≥ 500 cycles (gold plated)
- contact resistance: ≤ 3 mΩ
- for applications requiring higher voltages, please see the special voltage application section on page 30
- for contact crimping instructions, please see the crimping tool section (10A contacts, CDF and CDM series) on page 150
- for maximum current load, see the following load curves inserts, for more information see page 154

dimensions in mm

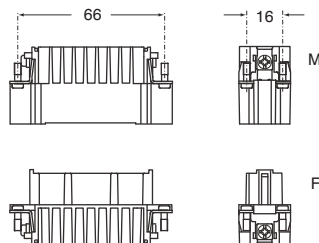

contacts side (front view)

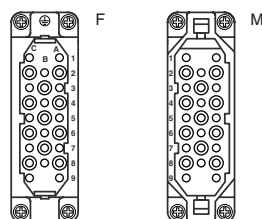

dimensions in mm

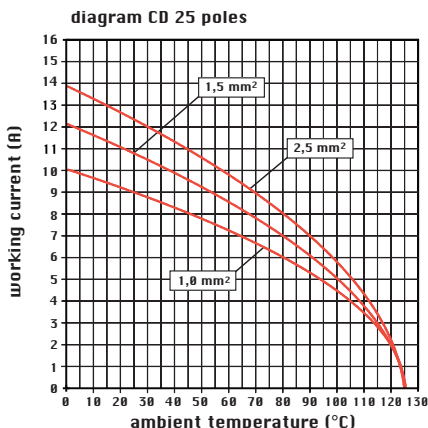
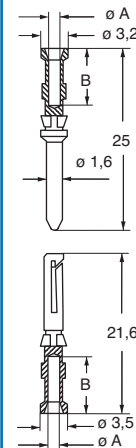

dimensions shown are not binding
and may be changed without notice

CDF and CDM contacts

conductor section mm ²	conductor slot ø A (mm)	conductors stripping length B (mm)
0,14-0,37	0,9	8
0,5	1,1	8
0,75	1,3	8
1,0	1,45	8
1,5	1,8	8
2,5	2,2	6

WARNING:

Do not use tin plated crimp contacts coupled with gold plated crimp contacts.

enclosures:

size "77.27" page:

JEI®-P thermoplastic lever 96 - 97

JEI®-V zinc-plated steel lever 110 - 114

T-TYPE IP65 insulating 138 - 139

panel supports: page:

COB + adaptor 143 - 145

inserts, crimp connections

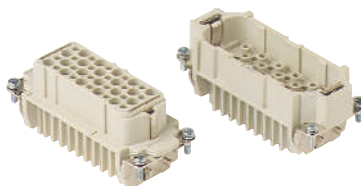

**10A crimp contacts
tin and gold plated**



description

part No.

part No.

part No.

without contacts (to be ordered separately)

female inserts for female contacts

male inserts for male contacts

CDF 40
CDM 40

10A female contacts

0,14-0,37 mm ²	AWG 26-22	identification No. 1
0,5 mm ²	AWG 20	identification No. 2
0,75 mm ²	AWG 18	identification No. ②
1 mm ²	AWG 18	identification No. 3
1,5 mm ²	AWG 16	identification No. 4
2,5 mm ²	AWG 14	identification No. 5

10A male contacts

0,14-0,37 mm ²	AWG 26-22	identification No. 1
0,5 mm ²	AWG 20	identification No. 2
0,75 mm ²	AWG 18	identification No. ②
1 mm ²	AWG 18	identification No. 3
1,5 mm ²	AWG 16	identification No. 4
2,5 mm ²	AWG 14	identification No. 5

CDFS 0.3
CDFS 0.5
CDFS 0.7
CDFS 1.0
CDFS 1.5
CDFS 2.5

tin plated

CDFJD 0.3
CDFJD 0.5
CDFJD 0.7
CDFJD 1.0
CDFJD 1.5
CDFJD 2.5

gold plated

CDMS 0.3
CDMS 0.5
CDMS 0.7
CDMS 1.0
CDMS 1.5
CDMS 2.5

CDMJD 0.3
CDMJD 0.5
CDMJD 0.7
CDMJD 1.0
CDMJD 1.5
CDMJD 2.5

- characteristics according to EN 61984:

10A 250V 4kV 3
10A 230/400V 4kV 2

- compliant with DIN EN 175 301-801 standard
- rated voltage according to UL/CSA: 600V
- insulation resistance: ≥ 10 GΩ
- ambient temperature limit: -40 °C ... +125 °C
- are made of self-extinguishing thermoplastic resin UL 94 V0
- mechanical life: ≥ 200 cycles (tin plated)
- mechanical life: ≥ 500 cycles (gold plated)
- contact resistance: ≤ 3 mΩ
- for applications requiring higher voltages, please see the special voltage application section on page 30
- for contact crimping instructions, please see the crimping tool section (10A contacts, CDF and CDM series) on page 150
- for maximum current load, see the following load curves inserts, for more information see page 154

dimensions in mm

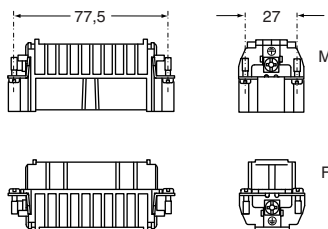

contacts side (front view)

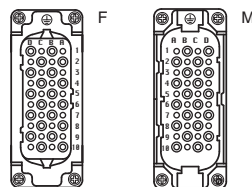

dimensions in mm

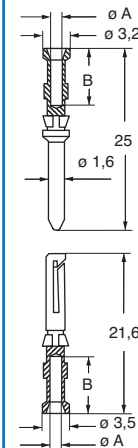
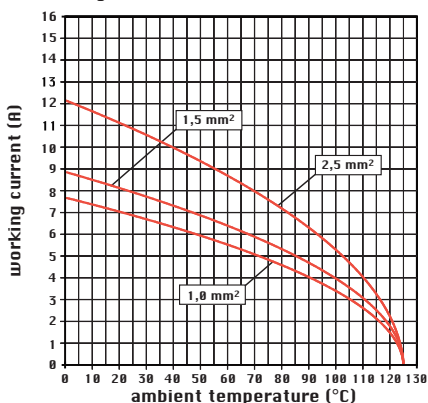

diagram CD 40 poles



dimensions shown are not binding
and may be changed without notice

CDF and CDM contacts

conductor section mm ²	conductor slot ø A (mm)	conductors stripping length B (mm)
0,14-0,37	0,9	8
0,5	1,1	8
0,75	1,3	8
1,0	1,45	8
1,5	1,8	8
2,5	2,2	6

WARNING:

Do not use tin plated crimp contacts coupled with gold plated crimp contacts.

enclosures:

size "104.27" page:

JEI®-P thermoplastic lever 98 - 99

JEI®-V zinc-plated steel lever 115 - 119

T-TYPE IP65 insulating 140 - 141

panel supports: page:

COB 143 - 144

inserts, crimp connections

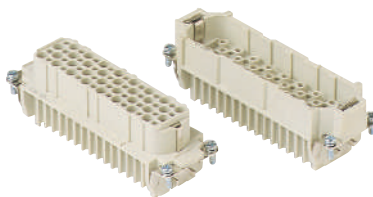

10A crimp contacts tin and gold plated



description

part No.

part No.

part No.

without contacts (to be ordered separately)

female inserts for female contacts

male inserts for male contacts

CDF 64
CDM 64

10A female contacts

0,14-0,37 mm ²	AWG 26-22	identification No. 1
0,5 mm ²	AWG 20	identification No. 2
0,75 mm ²	AWG 18	identification No. ②
1 mm ²	AWG 18	identification No. 3
1,5 mm ²	AWG 16	identification No. 4
2,5 mm ²	AWG 14	identification No. 5

10A male contacts

0,14-0,37 mm ²	AWG 26-22	identification No. 1
0,5 mm ²	AWG 20	identification No. 2
0,75 mm ²	AWG 18	identification No. ②
1 mm ²	AWG 18	identification No. 3
1,5 mm ²	AWG 16	identification No. 4
2,5 mm ²	AWG 14	identification No. 5

CDFS 0.3
CDFS 0.5
CDFS 0.7
CDFS 1.0
CDFS 1.5
CDFS 2.5

tin plated

CDFJD 0.3
CDFJD 0.5
CDFJD 0.7
CDFJD 1.0
CDFJD 1.5
CDFJD 2.5

gold plated

CDMS 0.3
CDMS 0.5
CDMS 0.7
CDMS 1.0
CDMS 1.5
CDMS 2.5

CDMJD 0.3
CDMJD 0.5
CDMJD 0.7
CDMJD 1.0
CDMJD 1.5
CDMJD 2.5

- characteristics according to EN 61984:

10A 250V 4kV 3
10A 230/400V 4kV 2

- compliant with DIN EN 175 301-801 standard
- rated voltage according to UL/CSA: 600V
- insulation resistance: ≥ 10 GΩ
- ambient temperature limit: -40 °C ... +125 °C
- are made of self-extinguishing thermoplastic resin UL 94 V0
- mechanical life: ≥ 200 cycles (tin plated)
- mechanical life: ≥ 500 cycles (gold plated)
- contact resistance: ≤ 3 mΩ
- for applications requiring higher voltages, please see the special voltage application section on page 30
- for contact crimping instructions, please see the crimping tool section (10A contacts, CDF and CDM series) on page 150
- for maximum current load, see the following load curves inserts, for more information see page 154

dimensions in mm

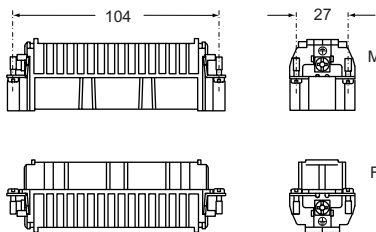

contacts side (front view)

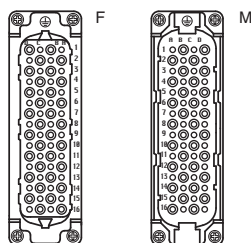

dimensions in mm

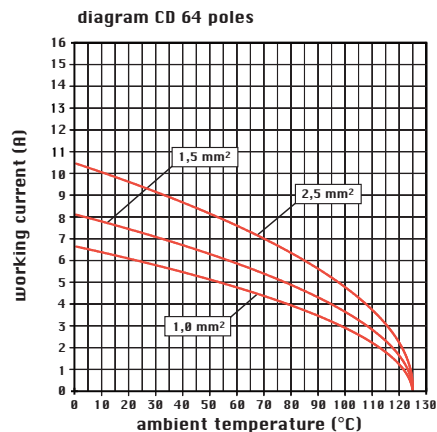
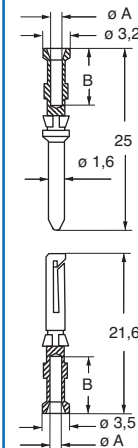

dimensions shown are not binding and may be changed without notice

CDF and CDM contacts

conductor section mm ²	conductor slot ø A (mm)	conductors stripping length B (mm)
0,14-0,37	0,9	8
0,5	1,1	8
0,75	1,3	8
1,0	1,45	8
1,5	1,8	8
2,5	2,2	6

WARNING:

Do not use tin plated crimp contacts coupled with gold plated crimp contacts.

enclosures:

size "77.62"

page:

JEI®-P thermoplastic lever 100 - 101

JEI®-V zinc-plated steel lever 120 - 121

inserts, crimp connections

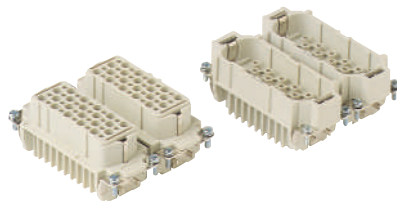

10A crimp contacts
tin and gold plated



description

part No.

part No.

part No.

part No.

without contacts (to be ordered separately)

female inserts

CDF 40
CDM 40

CDF 40
CDM 40

10A female contacts

0,14-0,37 mm ²	AWG 26-22	identification No. 1
0,5 mm ²	AWG 20	identification No. 2
0,75 mm ²	AWG 18	identification No. ②
1 mm ²	AWG 18	identification No. 3
1,5 mm ²	AWG 16	identification No. 4
2,5 mm ²	AWG 14	identification No. 5

10A male contacts

0,14-0,37 mm ²	AWG 26-22	identification No. 1
0,5 mm ²	AWG 20	identification No. 2
0,75 mm ²	AWG 18	identification No. ②
1 mm ²	AWG 18	identification No. 3
1,5 mm ²	AWG 16	identification No. 4
2,5 mm ²	AWG 14	identification No. 5

CDFS 0.3
CDFS 0.5
CDFS 0.7
CDFS 1.0
CDFS 1.5
CDFS 2.5

tin plated

CDFJD 0.3
CDFJD 0.5
CDFJD 0.7
CDFJD 1.0
CDFJD 1.5
CDFJD 2.5

gold plated

CDMS 0.3
CDMS 0.5
CDMS 0.7
CDMS 1.0
CDMS 1.5
CDMS 2.5

CDMJJD 0.3
CDMJJD 0.5
CDMJJD 0.7
CDMJJD 1.0
CDMJJD 1.5
CDMJJD 2.5

- characteristics according to EN 61984:

10A 250V 4kV 3
10A 230/400V 4kV 2

- compliant with DIN EN 175 301-801 standard
- rated voltage according to UL/CSA: 600V
- insulation resistance: ≥ 10 GΩ
- ambient temperature limit: -40 °C ... +125 °C
- are made of self-extinguishing thermoplastic resin UL 94 V0
- mechanical life: ≥ 200 cycles (tin plated)
- mechanical life: ≥ 500 cycles (gold plated)
- contact resistance: ≤ 3 mΩ
- for applications requiring higher voltages, please see the special voltage application section on page 30
- for contact crimping instructions, please see the crimping tool section (10A contacts, CDF and CDM series) on page 150
- for maximum current load, see the following load curves inserts, for more information see page 154

dimensions in mm

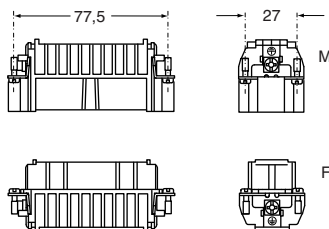

contacts side (front view)

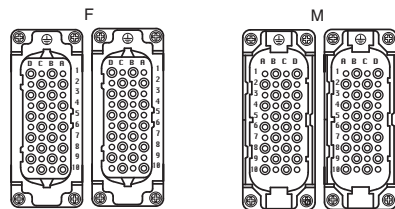

dimensions in mm

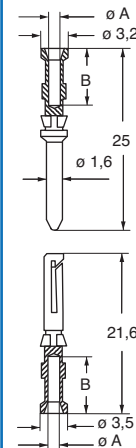
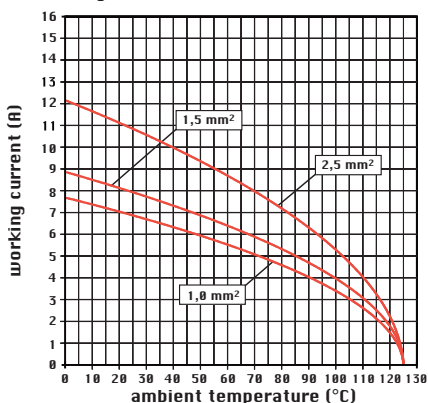

diagram CD 80 poles



dimensions shown are not binding
and may be changed without notice

CDF and CDM contacts

conductor section mm ²	conductor slot ø A (mm)	conductors stripping length B (mm)
0,14-0,37	0,9	8
0,5	1,1	8
0,75	1,3	8
1,0	1,45	8
1,5	1,8	8
2,5	2,2	6

WARNING:

Do not use tin plated crimp contacts coupled with gold plated crimp contacts.

enclosures:

size "104.62"

page:

JEI®-V zinc-plated steel lever 122

inserts, crimp connections

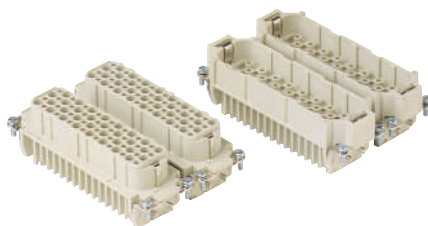

10A crimp contacts
tin and gold plated



description

part No.

part No.

part No.

part No.

without contacts (to be ordered separately)

female inserts

CDF 64
CDM 64

CDF 64
CDM 64

10A female contacts

0,14-0,37 mm ²	AWG 26-22	identification No. 1
0,5 mm ²	AWG 20	identification No. 2
0,75 mm ²	AWG 18	identification No. ②
1 mm ²	AWG 18	identification No. 3
1,5 mm ²	AWG 16	identification No. 4
2,5 mm ²	AWG 14	identification No. 5

10A male contacts

0,14-0,37 mm ²	AWG 26-22	identification No. 1
0,5 mm ²	AWG 20	identification No. 2
0,75 mm ²	AWG 18	identification No. ②
1 mm ²	AWG 18	identification No. 3
1,5 mm ²	AWG 16	identification No. 4
2,5 mm ²	AWG 14	identification No. 5

CDFS 0.3
CDFS 0.5
CDFS 0.7
CDFS 1.0
CDFS 1.5
CDFS 2.5

tin plated

CDFJD 0.3
CDFJD 0.5
CDFJD 0.7
CDFJD 1.0
CDFJD 1.5
CDFJD 2.5

gold plated

CDMS 0.3
CDMS 0.5
CDMS 0.7
CDMS 1.0
CDMS 1.5
CDMS 2.5

CDMJD 0.3
CDMJD 0.5
CDMJD 0.7
CDMJD 1.0
CDMJD 1.5
CDMJD 2.5

- characteristics according to EN 61984:

10A 250V 4kV 3
10A 230/400V 4kV 2

- compliant with DIN EN 175 301-801 standard
- rated voltage according to UL/CSA: 600V
- insulation resistance: ≥ 10 GΩ
- ambient temperature limit: -40 °C ... +125 °C
- are made of self-extinguishing thermoplastic resin UL 94 V0
- mechanical life: ≥ 200 cycles (tin plated)
- mechanical life: ≥ 500 cycles (gold plated)
- contact resistance: ≤ 3 mΩ
- for applications requiring higher voltages, please see the special voltage application section on page 30
- for contact crimping instructions, please see the crimping tool section (10A contacts, CDF and CDM series) on page 150
- for maximum current load, see the following load curves inserts, for more information see page 154

dimensions in mm

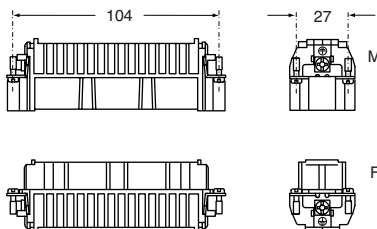

contacts side (front view)

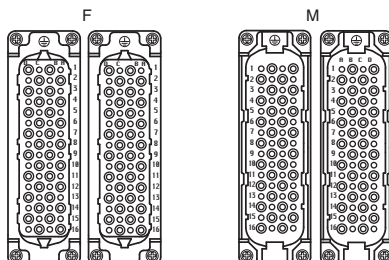

dimensions in mm

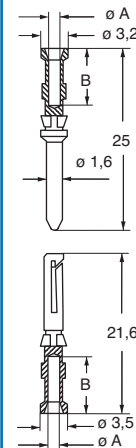
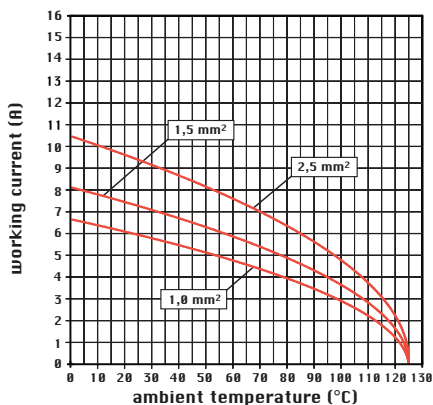

diagram CD 128 poles



dimensions shown are not binding
and may be changed without notice

CDF and CDM contacts

conductor section mm ²	conductor slot ø A (mm)	conductors stripping length B (mm)
0,14-0,37	0,9	8
0,5	1,1	8
0,75	1,3	8
1,0	1,45	8
1,5	1,8	8
2,5	2,2	6

WARNING:

Do not use tin plated crimp contacts coupled with gold plated crimp contacts.

When all the contacts are used, the CDD inserts series connectors may be used with voltages of up to 250V (first column); pollution rate 2, in accordance with the standard EN 61984.

If the number of contacts is reduced and the contacts accordingly assigned, these connectors may be used with higher voltages. This is possible because the decrease in the number of contacts leads to an increase in the surface insulation distance in the air. When the contacts are arranged as shown below, the inserts may be used for voltages of 400V (second column) and 500V (third column); pollution rate 2, in accordance with the standard EN 61984.

Legend:

- working contact
- without contact
- M = male insert
- F = female insert

for use up to 250V
pollution rate 2

diagrams
contacts side (front view)

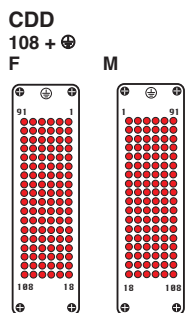
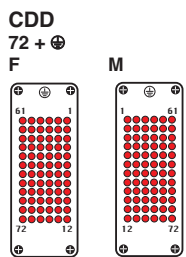
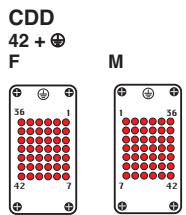
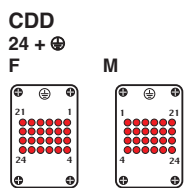

for use up to 400V
pollution rate 2

diagrams
contacts side (front view)

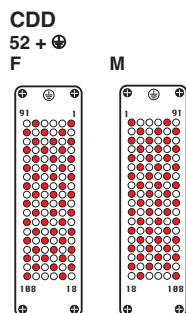
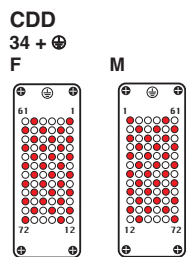
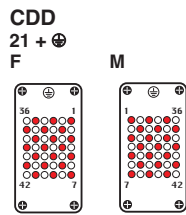
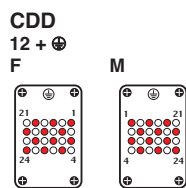

for use up to 500V
pollution rate 2

diagrams
contacts side (front view)

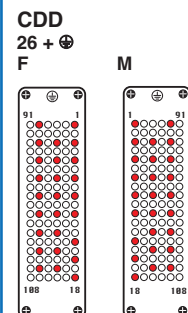
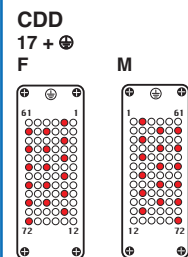
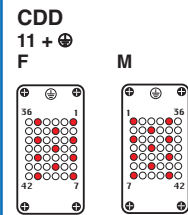
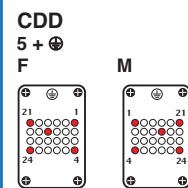

enclosures:

 size "44.27" page:
JEI®-P thermoplastic lever 92 - 93

JEI®-V zinc-plated steel lever 102 - 104

T-TYPE IP65 insulating 134 - 135

 panel supports: page:
COB 143 - 144

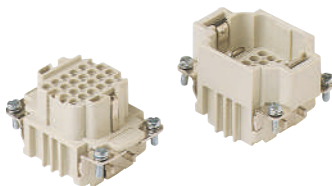
inserts, crimp connections

**10A crimp contacts
tin and gold plated**

description

part No.

part No.

part No.

without contacts (to be ordered separately)

female inserts for female contacts

male inserts for male contacts

**CDDF 24
CDDM 24**
10A female contacts

0,14-0,37 mm ²	AWG 26-22	identification No. 1
0,5 mm ²	AWG 20	identification No. 2
0,75 mm ²	AWG 18	identification No. ②
1 mm ²	AWG 18	identification No. 3
1,5 mm ²	AWG 16	identification No. 4
2,5 mm ²	AWG 14	identification No. 5

10A male contacts

0,14-0,37 mm ²	AWG 26-22	identification No. 1
0,5 mm ²	AWG 20	identification No. 2
0,75 mm ²	AWG 18	identification No. ②
1 mm ²	AWG 18	identification No. 3
1,5 mm ²	AWG 16	identification No. 4
2,5 mm ²	AWG 14	identification No. 5

tin plated
 CDFS 0.3
 CDFS 0.5
 CDFS 0.7
 CDFS 1.0
 CDFS 1.5
 CDFS 2.5

gold plated
 CDFJD 0.3
 CDFJD 0.5
 CDFJD 0.7
 CDFJD 1.0
 CDFJD 1.5
 CDFJD 2.5

**CDMS 0.3
CDMS 0.5
CDMS 0.7
CDMS 1.0
CDMS 1.5
CDMS 2.5**
**CDMJ 0.3
CDMJ 0.5
CDMJ 0.7
CDMJ 1.0
CDMJ 1.5
CDMJ 2.5**

- characteristics according to EN 61984:

10A 250V 4kV 2

- rated voltage according to UL/CSA: 600V
- insulation resistance: $\geq 10 \text{ G}\Omega$
- ambient temperature limit: $-40 \text{ }^\circ\text{C} \dots +125 \text{ }^\circ\text{C}$
- are made of self-extinguishing thermoplastic resin UL 94 V0
- mechanical life: ≥ 200 cycles (tin plated)
- mechanical life: ≥ 500 cycles (gold plated)
- contact resistance: $\leq 3 \text{ m}\Omega$
- for applications requiring higher voltages, please see the special voltage application section on page 39
- for contact crimping instructions, please see the crimping tool section (10A contacts, CDF and CDM series) on page 150
- for maximum current load, see the following load curves inserts, for more information see page 154

dimensions in mm

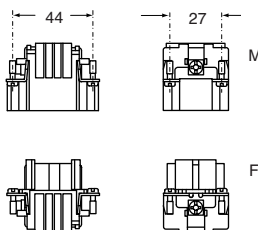

contacts side (front view)

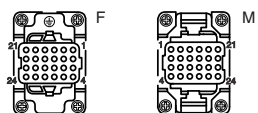

dimensions in mm

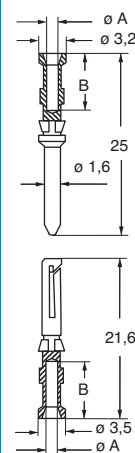
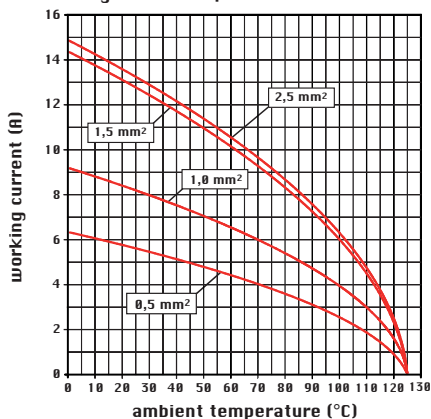
diagram CDD 24 poles

 dimensions shown are not binding
and may be changed without notice

CDF and CDM contacts

conductor section mm ²	conductor slot $\varnothing A$ (mm)	conductors stripping length B (mm)
0,14-0,37	0,9	8
0,5	1,1	8
0,75	1,3	8
1,0	1,45	8
1,5	1,8	8
2,5	2,2	6

WARNING:

Do not use tin plated crimp contacts coupled with gold plated crimp contacts.

enclosures:

size "66.16"

page:

JEI®-P thermoplastic lever 90 - 91

panel supports:

page:

COB + adaptor 143 - 145

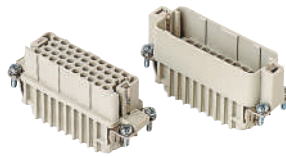
inserts, crimp connections

**10A crimp contacts
tin and gold plated**

description	part No.	part No.	part No.
-------------	----------	----------	----------

 without contacts (to be ordered separately)
 female inserts for female contacts
 male inserts for male contacts

CDDF 38
CDDM 38
10A female contacts

cross-section	AWG	identification No.
0,14-0,37 mm ²	AWG 26-22	1
0,5 mm ²	AWG 20	2
0,75 mm ²	AWG 18	②
1 mm ²	AWG 18	3
1,5 mm ²	AWG 16	4
2,5 mm ²	AWG 14	5

10A male contacts

cross-section	AWG	identification No.
0,14-0,37 mm ²	AWG 26-22	1
0,5 mm ²	AWG 20	2
0,75 mm ²	AWG 18	②
1 mm ²	AWG 18	3
1,5 mm ²	AWG 16	4
2,5 mm ²	AWG 14	5

tin plated
CDFS 0.3
CDFS 0.5
CDFS 0.7
CDFS 1.0
CDFS 1.5
CDFS 2.5
gold plated
PDFJD 0.3
PDFJD 0.5
PDFJD 0.7
PDFJD 1.0
PDFJD 1.5
PDFJD 2.5
CDMS 0.3
CDMS 0.5
CDMS 0.7
CDMS 1.0
CDMS 1.5
CDMS 2.5
CDMJ 0.3
CDMJ 0.5
CDMJ 0.7
CDMJ 1.0
CDMJ 1.5
CDMJ 2.5

- characteristics according to EN 61984:

10A 250V 4kV 2

- rated voltage according to UL/CSA: 600V
- insulation resistance: $\geq 10 \text{ G}\Omega$
- ambient temperature limit: $-40 \text{ }^\circ\text{C} \dots +125 \text{ }^\circ\text{C}$
- are made of self-extinguishing thermoplastic resin UL 94 V0
- mechanical life: ≥ 200 cycles (tin plated)
- mechanical life: ≥ 500 cycles (gold plated)
- contact resistance: $\leq 3 \text{ m}\Omega$
- for contact crimping instructions, please see the crimping tool section (10A contacts, CDF and CDM series) on page 150
- for maximum current load, see the following load curves inserts, for more information see page 154

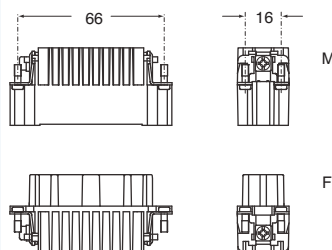
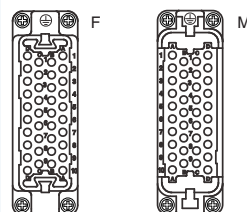
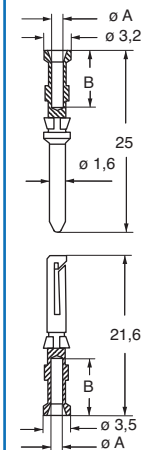
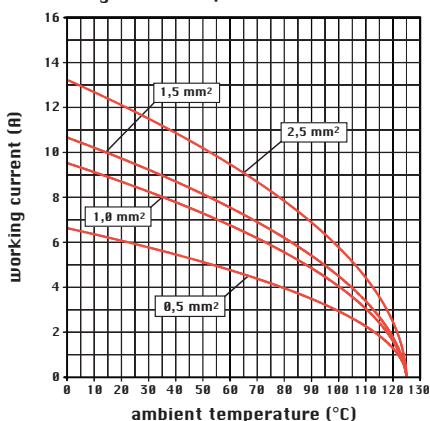
dimensions in mm

contacts side (front view)

dimensions in mm

diagram CDD 38 poles

 dimensions shown are not binding
 and may be changed without notice

CDF and CDM contacts

conductor section mm ²	conductor slot ø A (mm)	conductors stripping length B (mm)
0,14-0,37	0,9	8
0,5	1,1	8
0,75	1,3	8
1,0	1,45	8
1,5	1,8	8
2,5	2,2	6

WARNING:

Do not use tin plated crimp contacts coupled with gold plated crimp contacts.

enclosures:

size "57.27" page:

JEI®-P thermoplastic lever 94 - 95

JEI®-V zinc-plated steel lever 105 - 109

T-TYPE IP65 insulating 136 - 137

panel supports: page:

COB + adaptor 143 - 145

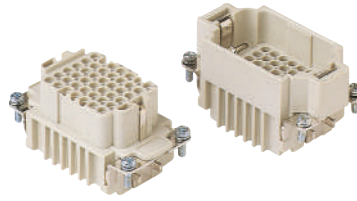
inserts, crimp connections

**10A crimp contacts
tin and gold plated**

description	part No.	part No.	part No.
-------------	----------	----------	----------

 without contacts (to be ordered separately)
 female inserts for female contacts
 male inserts for male contacts

CDDF 42
CDDM 42
10A female contacts

cross-section	AWG	identification No.
0,14-0,37 mm ²	26-22	1
0,5 mm ²	20	2
0,75 mm ²	18	②
1 mm ²	18	3
1,5 mm ²	16	4
2,5 mm ²	14	5

10A male contacts

cross-section	AWG	identification No.
0,14-0,37 mm ²	26-22	1
0,5 mm ²	20	2
0,75 mm ²	18	②
1 mm ²	18	3
1,5 mm ²	16	4
2,5 mm ²	14	5

CDFS 0.3
CDFS 0.5
CDFS 0.7
CDFS 1.0
CDFS 1.5
CDFS 2.5

tin plated

CDFJD 0.3
CDFJD 0.5
CDFJD 0.7
CDFJD 1.0
CDFJD 1.5
CDFJD 2.5

gold plated

CDMS 0.3
CDMS 0.5
CDMS 0.7
CDMS 1.0
CDMS 1.5
CDMS 2.5
CDMJD 0.3
CDMJD 0.5
CDMJD 0.7
CDMJD 1.0
CDMJD 1.5
CDMJD 2.5

- characteristics according to EN 61984:

10A 250V 4kV 2

- rated voltage according to UL/CSA: 600V
- insulation resistance: $\geq 10 \text{ G}\Omega$
- ambient temperature limit: $-40 \text{ }^\circ\text{C} \dots +125 \text{ }^\circ\text{C}$
- are made of self-extinguishing thermoplastic resin UL 94 V0
- mechanical life: ≥ 200 cycles (tin plated)
- mechanical life: ≥ 500 cycles (gold plated)
- contact resistance: $\leq 3 \text{ m}\Omega$
- for applications requiring higher voltages, please see the special voltage application section on page 39
- for contact crimping instructions, please see the crimping tool section (10A contacts, CDF and CDM series) on page 150
- for maximum current load, see the following load curves inserts, for more information see page 154

dimensions in mm

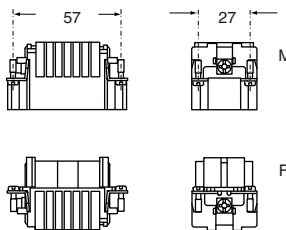

contacts side (front view)

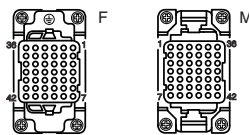

dimensions in mm

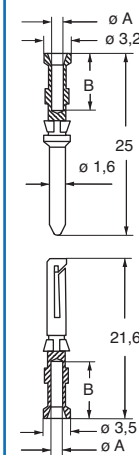
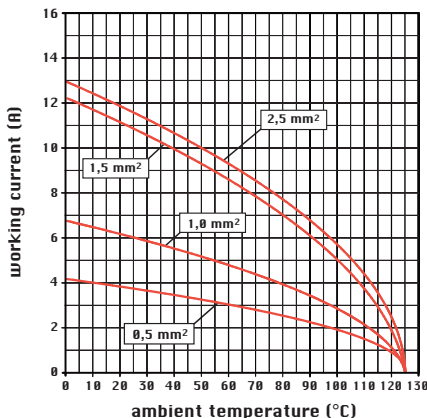
diagram CDD 42 poles

 dimensions shown are not binding
 and may be changed without notice

CDF and CDM contacts

conductor section mm ²	conductor slot $\varnothing A$ (mm)	conductors stripping length B (mm)
0,14-0,37	0,9	8
0,5	1,1	8
0,75	1,3	8
1,0	1,45	8
1,5	1,8	8
2,5	2,2	6

WARNING:

Do not use tin plated crimp contacts coupled with gold plated crimp contacts.

enclosures:

 size "77.27" page:
JEI®-P thermoplastic lever 96 - 97

JEI®-V zinc-plated steel lever 110 - 114

T-TYPE IP65 insulating 138 - 139

 panel supports: page:
COB + adaptor 143 - 145

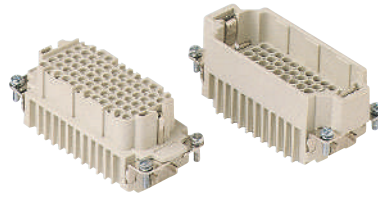
inserts, crimp connections

**10A crimp contacts
tin and gold plated**

description	part No.	part No.	part No.
-------------	----------	----------	----------

 without contacts (to be ordered separately)
 female inserts for female contacts
 male inserts for male contacts

CDDF 72
CDDM 72
10A female contacts

Area (mm ²)	AWG	Identification No.
0,14-0,37	26-22	1
0,5	20	2
0,75	18	②
1	18	3
1,5	16	4
2,5	14	5

10A male contacts

Area (mm ²)	AWG	Identification No.
0,14-0,37	26-22	1
0,5	20	2
0,75	18	②
1	18	3
1,5	16	4
2,5	14	5

CDFS 0.3
CDFS 0.5
CDFS 0.7
CDFS 1.0
CDFS 1.5
CDFS 2.5

tin plated

CDFJD 0.3
CDFJD 0.5
CDFJD 0.7
CDFJD 1.0
CDFJD 1.5
CDFJD 2.5

gold plated

CDMS 0.3
CDMS 0.5
CDMS 0.7
CDMS 1.0
CDMS 1.5
CDMS 2.5
CDMJD 0.3
CDMJD 0.5
CDMJD 0.7
CDMJD 1.0
CDMJD 1.5
CDMJD 2.5

- characteristics according to EN 61984:

10A 250V 4kV 2

- rated voltage according to UL/CSA: 600V
- insulation resistance: $\geq 10 \text{ G}\Omega$
- ambient temperature limit: $-40 \text{ }^\circ\text{C} \dots +125 \text{ }^\circ\text{C}$
- are made of self-extinguishing thermoplastic resin UL 94 V0
- mechanical life: ≥ 200 cycles (tin plated)
- mechanical life: ≥ 500 cycles (gold plated)
- contact resistance: $\leq 3 \text{ m}\Omega$
- for applications requiring higher voltages, please see the special voltage application section on page 39
- for contact crimping instructions, please see the crimping tool section (10A contacts, CDF and CDM series) on page 150
- for maximum current load, see the following load curves inserts, for more information see page 154

dimensions in mm

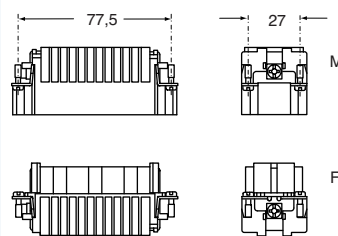

contacts side (front view)

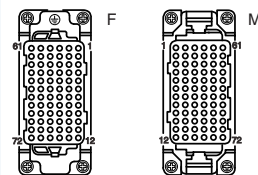

dimensions in mm

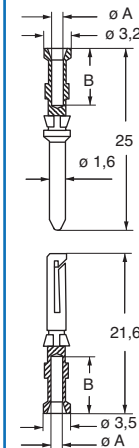
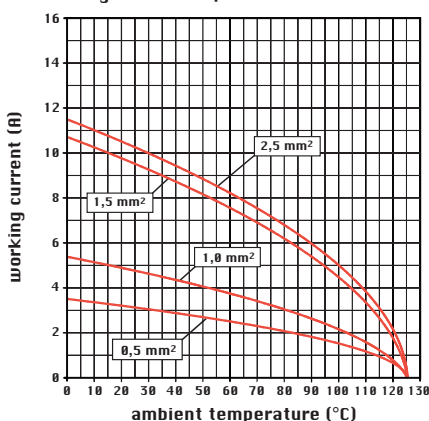
diagram CDD 72 poles

 dimensions shown are not binding
 and may be changed without notice

CDF and CDM contacts

conductor section mm ²	conductor slot $\varnothing A$ (mm)	conductors stripping length B (mm)
0,14-0,37	0,9	8
0,5	1,1	8
0,75	1,3	8
1,0	1,45	8
1,5	1,8	8
2,5	2,2	6

WARNING:

Do not use tin plated crimp contacts coupled with gold plated crimp contacts.

enclosures:

size "104.27" page:

JEI®-P thermoplastic lever 98 - 99

JEI®-V zinc-plated steel lever 115 - 119

T-TYPE IP65 insulating 140 - 141

panel supports: page:

COB 143 - 144

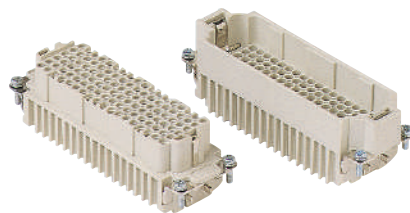
inserts, crimp connections

**10A crimp contacts
tin and gold plated**

description

part No.

part No.

part No.

without contacts (to be ordered separately)

female inserts for female contacts

male inserts for male contacts

CDDF 108
CDDM 108
10A female contacts

0,14-0,37 mm ²	AWG 26-22	identification No. 1
0,5 mm ²	AWG 20	identification No. 2
0,75 mm ²	AWG 18	identification No. ②
1 mm ²	AWG 18	identification No. 3
1,5 mm ²	AWG 16	identification No. 4
2,5 mm ²	AWG 14	identification No. 5

10A male contacts

0,14-0,37 mm ²	AWG 26-22	identification No. 1
0,5 mm ²	AWG 20	identification No. 2
0,75 mm ²	AWG 18	identification No. ②
1 mm ²	AWG 18	identification No. 3
1,5 mm ²	AWG 16	identification No. 4
2,5 mm ²	AWG 14	identification No. 5

CDFS 0.3
CDFS 0.5
CDFS 0.7
CDFS 1.0
CDFS 1.5
CDFS 2.5
tin plated
CDFJD 0.3
CDFJD 0.5
CDFJD 0.7
CDFJD 1.0
CDFJD 1.5
CDFJD 2.5
gold plated
CDMS 0.3
CDMS 0.5
CDMS 0.7
CDMS 1.0
CDMS 1.5
CDMS 2.5
CDMJD 0.3
CDMJD 0.5
CDMJD 0.7
CDMJD 1.0
CDMJD 1.5
CDMJD 2.5

- characteristics according to EN 61984:

10A 250V 4kV 2

- rated voltage according to UL/CSA: 600V
- insulation resistance: $\geq 10 \text{ G}\Omega$
- ambient temperature limit: $-40 \text{ }^\circ\text{C} \dots +125 \text{ }^\circ\text{C}$
- are made of self-extinguishing thermoplastic resin UL 94 V0
- mechanical life: ≥ 200 cycles (tin plated)
- mechanical life: ≥ 500 cycles (gold plated)
- contact resistance: $\leq 3 \text{ m}\Omega$
- for applications requiring higher voltages, please see the special voltage application section on page 39
- for contact crimping instructions, please see the crimping tool section (10A contacts, CDF and CDM series) on page 150
- for maximum current load, see the following load curves inserts, for more information see page 154

dimensions in mm

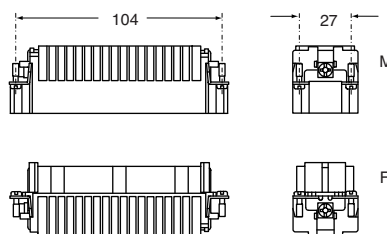

contacts side (front view)

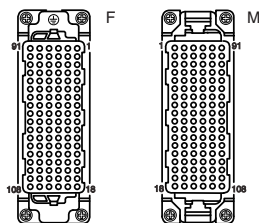

dimensions in mm

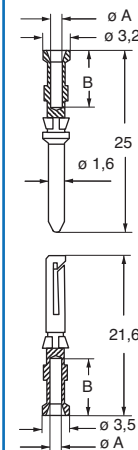
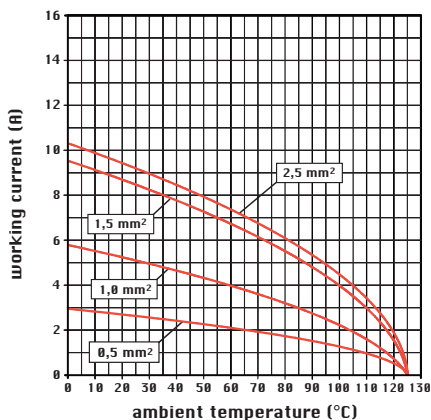
diagram CDD 108 poles

 dimensions shown are not binding
 and may be changed without notice

CDF and CDM contacts

conductor section mm ²	conductor slot $\varnothing A$ (mm)	conductors stripping length B (mm)
0,14-0,37	0,9	8
0,5	1,1	8
0,75	1,3	8
1,0	1,45	8
1,5	1,8	8
2,5	2,2	6

WARNING:

Do not use tin plated crimp contacts coupled with gold plated crimp contacts.

enclosures:

size "77.62"

page:

JEI®-P thermoplastic lever 100 - 101

JEI®-V zinc-plated steel lever 120 - 121

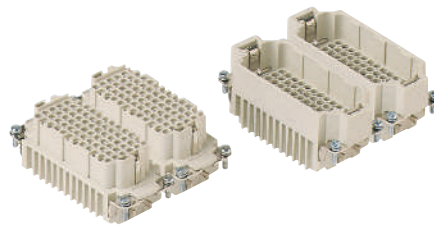
inserts, crimp connections

**10A crimp contacts
tin and gold plated**



description	part No.	part No.	part No.	part No.
without contacts (to be ordered separately) female inserts, No. (1-72) and (73-144) male inserts, No. (1-72) and (73-144)	CDDF 72 CDDM 72	CDDF 72 N CDDM 72 N		
10A female contacts 0,14-0,37 mm ² AWG 26-22 identification No. 1 0,5 mm ² AWG 20 identification No. 2 0,75 mm ² AWG 18 identification No. ② 1 mm ² AWG 18 identification No. 3 1,5 mm ² AWG 16 identification No. 4 2,5 mm ² AWG 14 identification No. 5			CDFS 0.3 CDFS 0.5 CDFS 0.7 CDFS 1.0 CDFS 1.5 CDFS 2.5	CDFJD 0.3 CDFJD 0.5 CDFJD 0.7 CDFJD 1.0 CDFJD 1.5 CDFJD 2.5
10A male contacts 0,14-0,37 mm ² AWG 26-22 identification No. 1 0,5 mm ² AWG 20 identification No. 2 0,75 mm ² AWG 18 identification No. ② 1 mm ² AWG 18 identification No. 3 1,5 mm ² AWG 16 identification No. 4 2,5 mm ² AWG 14 identification No. 5			CDMS 0.3 CDMS 0.5 CDMS 0.7 CDMS 1.0 CDMS 1.5 CDMS 2.5	CDMJD 0.3 CDMJD 0.5 CDMJD 0.7 CDMJD 1.0 CDMJD 1.5 CDMJD 2.5

- characteristics according to EN 61984:

10A 250V 4kV 2

- rated voltage according to UL/CSA: 600V
- insulation resistance: $\geq 10 \text{ G}\Omega$
- ambient temperature limit: $-40 \text{ }^\circ\text{C} \dots +125 \text{ }^\circ\text{C}$
- are made of self-extinguishing thermoplastic resin UL 94 V0
- mechanical life: ≥ 200 cycles (tin plated)
- mechanical life: ≥ 500 cycles (gold plated)
- contact resistance: $\leq 3 \text{ m}\Omega$
- for applications requiring higher voltages, please see the special voltage application section on page 39
- for contact crimping instructions, please see the crimping tool section (10A contacts, CDF and CDM series) on page 150
- for maximum current load, see the following load curves inserts, for more information see page 154

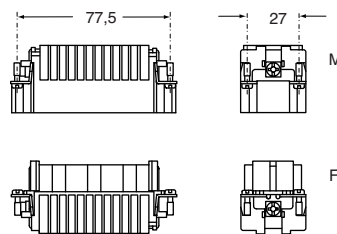
dimensions in mm



dimensions in mm

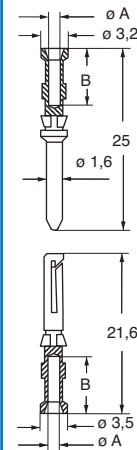

contacts side (front view)

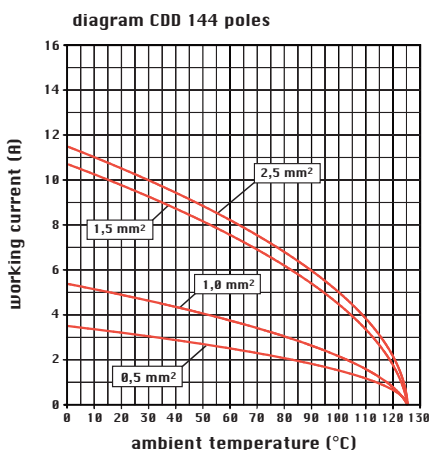
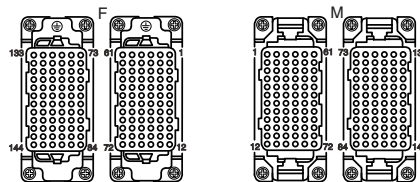
 dimensions shown are not binding
and may be changed without notice

CDF and CDM contacts

conductor section mm ²	conductor slot ø A (mm)	conductors stripping length B (mm)
0,14-0,37	0,9	8
0,5	1,1	8
0,75	1,3	8
1,0	1,45	8
1,5	1,8	8
2,5	2,2	6

WARNING:

Do not use tin plated crimp contacts coupled with gold plated crimp contacts.

enclosures:

size "104.62"

page:

JEI®-V zinc-plated steel lever 122

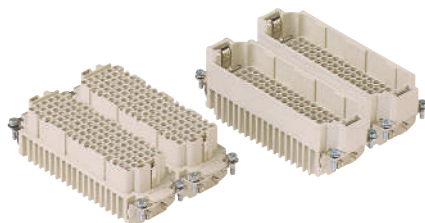
inserts, crimp connections

**10A crimp contacts
tin and gold plated**

description

part No.

part No.

part No.

part No.

 without contacts (to be ordered separately)
 female inserts, No. (1-108) and (109-216)
 male inserts, No. (1-108) and (109-216)

CDDF 108
CDDM 108
CDDF 108 N
CDDM 108 N
10A female contacts

0,14-0,37 mm ²	AWG 26-22	identification No. 1
0,5 mm ²	AWG 20	identification No. 2
0,75 mm ²	AWG 18	identification No. ②
1 mm ²	AWG 18	identification No. 3
1,5 mm ²	AWG 16	identification No. 4
2,5 mm ²	AWG 14	identification No. 5

10A male contacts

0,14-0,37 mm ²	AWG 26-22	identification No. 1
0,5 mm ²	AWG 20	identification No. 2
0,75 mm ²	AWG 18	identification No. ②
1 mm ²	AWG 18	identification No. 3
1,5 mm ²	AWG 16	identification No. 4
2,5 mm ²	AWG 14	identification No. 5

CDFS 0.3
CDFS 0.5
CDFS 0.7
CDFS 1.0
CDFS 1.5
CDFS 2.5
tin plated
CDFJD 0.3
CDFJD 0.5
CDFJD 0.7
CDFJD 1.0
CDFJD 1.5
CDFJD 2.5
gold plated
CDMS 0.3
CDMS 0.5
CDMS 0.7
CDMS 1.0
CDMS 1.5
CDMS 2.5
CDMJJD 0.3
CDMJJD 0.5
CDMJJD 0.7
CDMJJD 1.0
CDMJJD 1.5
CDMJJD 2.5

- characteristics according to EN 61984:

10A 250V 4kV 2

- rated voltage according to UL/CSA: 600V
- insulation resistance: $\geq 10 \text{ G}\Omega$
- ambient temperature limit: $-40 \text{ }^\circ\text{C} \dots +125 \text{ }^\circ\text{C}$
- are made of self-extinguishing thermoplastic resin UL 94 V0
- mechanical life: ≥ 200 cycles (tin plated)
- mechanical life: ≥ 500 cycles (gold plated)
- contact resistance: $\leq 3 \text{ m}\Omega$
- for applications requiring higher voltages, please see the special voltage application section on page 39
- for contact crimping instructions, please see the crimping tool section (10A contacts, CDF and CDM series) on page 150
- for maximum current load, see the following load curves inserts, for more information see page 154

dimensions in mm

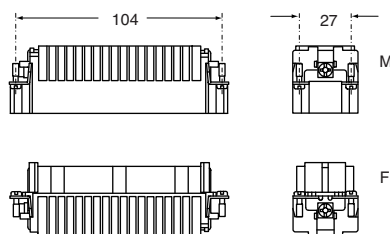

contacts side (front view)

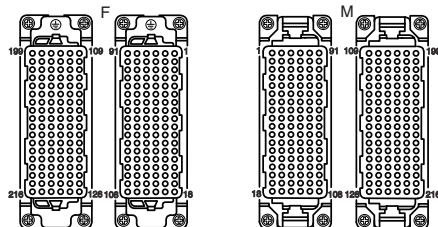

dimensions in mm

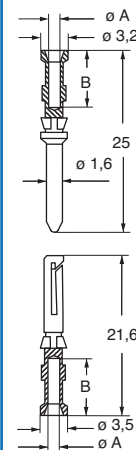
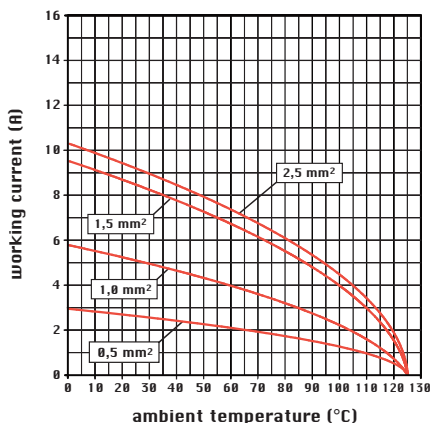
diagram CDD 216 poles

 dimensions shown are not binding
 and may be changed without notice

CDF and CDM contacts

conductor section mm ²	conductor slot $\varnothing A$ (mm)	conductors stripping length B (mm)
0,14-0,37	0,9	8
0,5	1,1	8
0,75	1,3	8
1,0	1,45	8
1,5	1,8	8
2,5	2,2	6

WARNING:

Do not use tin plated crimp contacts coupled with gold plated crimp contacts.



enclosures:

size "49.16"

page:

JEI®-P thermoplastic lever 88 - 89

panel supports:

page:

COB + adaptor 143 - 145

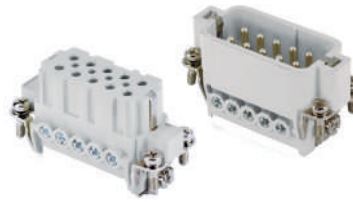
**inserts,
screw terminal connections**

 tin plated
contacts

description

part No.

 indirect , without plate ¹⁾

female inserts with female contacts

male inserts with male contacts

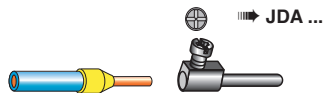
**JDAF 10
JDAM 10**
¹⁾ for bush terminal conductors

dimensions in mm

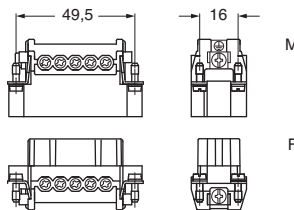

- characteristics according to EN 61984:

16A 250V 4kV 3
16A 230/400V 4kV 2

 - insulation resistance: $\geq 10 \text{ G}\Omega$

 - ambient temperature limit: $-40 \text{ }^\circ\text{C} \dots +125 \text{ }^\circ\text{C}$

- are made of self-extinguishing thermoplastic resin UL 94 V0

 - mechanical life: ≥ 200 cycles

 - contact resistance: $\leq 3 \text{ m}\Omega$

- for maximum current load, see the following load curves inserts

contacts side (front view)

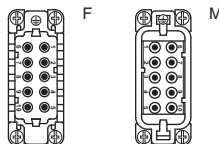
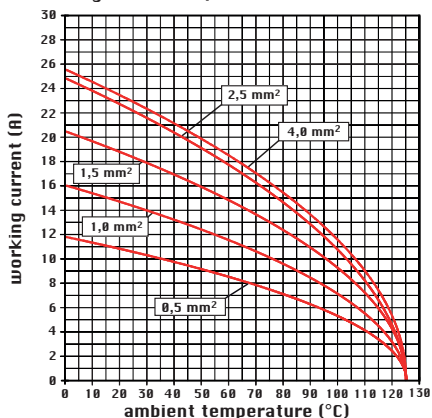

diagram JDA 10 poles



- inserts without plate for section conductors:

 0,25 - 2,5 mm² - AWG 24 - 14

- the stripping length for prepared wires with bush

crimped depends on that of the bush itself

- terminal screw torque: 0,5 Nm, for more information

see page 19

 dimensions shown are not binding
and may be changed without notice

enclosures:

size "66.16"

page:

JEI®-P thermoplastic lever 90 - 91

panel supports:

page:

COB + adaptor 143 - 145

**inserts,
screw terminal connections**

 tin plated
contacts

description

part No.

 indirect , without plate ¹⁾

female inserts with female contacts

male inserts with male contacts

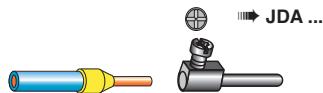
JDAF 16
JDAM 16
¹⁾ for bush terminal conductors

- characteristics according to EN 61984:

16A 250V 4kV 3
16A 230/400V 4kV 2

 - insulation resistance: $\geq 10 \text{ G}\Omega$

 - ambient temperature limit: $-40 \text{ }^\circ\text{C} \dots +125 \text{ }^\circ\text{C}$

- are made of self-extinguishing thermoplastic resin UL 94 V0

 - mechanical life: ≥ 200 cycles

 - contact resistance: $\leq 3 \text{ m}\Omega$

 - for maximum current load, see the following load curves
 inserts

dimensions in mm

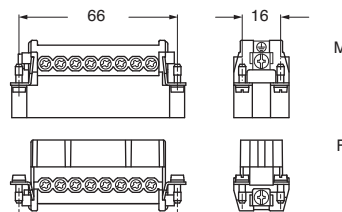

contacts side (front view)

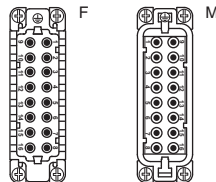
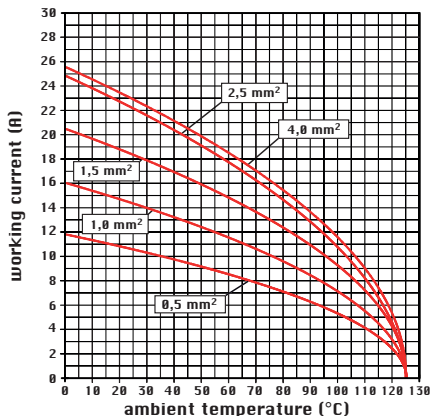

diagram JDA 16 poles



- inserts without plate for section conductors:

 0,25 - 2,5 mm² - AWG 24 - 14

- the stripping length for prepared wires with bush

crimped depends on that of the bush itself

- terminal screw torque: 0,5 Nm, for more information

see page 19

 dimensions shown are not binding
 and may be changed without notice

HIGH DENSITY

**STANDARD
16A**

**JDS
HIGH DENSITY
10A**

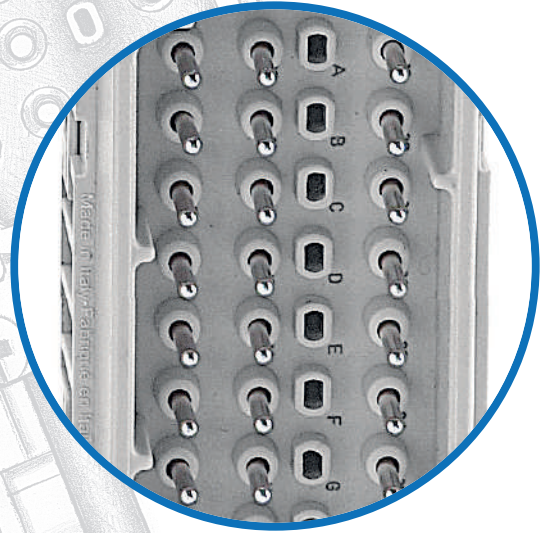
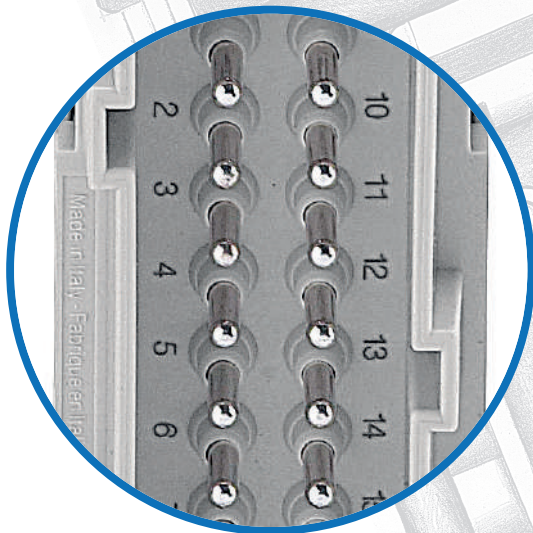

**10A
spring connection**

The originality of multipole connectors represents one of the core values of ILME, a leading company in this segment.

The continuous demand for a greater number of poles and of smaller dimensions has led to the design and manufacture of the new CDS series, which offers single connectors with a maximum number of 84 poles that occupy the same space of standard connectors with screw/spring connection.

The compact spring connection enables the occupied space to be reduced and avoids using “CRIMP” solutions that require the use of special tools.

STANDARD 16A		JDS - HIGH DENSITY 10A	
06 poles	→	09 poles	+50%
10 poles	→	18 poles	+80%
16 poles	→	27 poles	+70%
24 poles	→	42 poles	+75%
32 poles	→	54 poles	+70%
48 poles	→	84 poles	+75%



The new **JDS series**, which is an evolution as compared to the compact JKS series, offers the following advantages:

- Greater pole density as compared to existing connectors with screw terminals for enclosures of the same size
- Possibility of using wires up to 2,5 mm² (AWG 14) and availability of a useful section 1,5 mm² (AWG 16) for flexible wires terminated with crimp ferrule
- A screwdriver with a 0,5 x 3,5 mm blade is the only tool required to insert the wire into the contact or to open the spring connection
- No special wire preparation other than stripping
- An excellent fastening solution and a great resistance to strong vibrations
- Allows conductivity tests under load to be carried out by inserting the probes in the screwdriver insertion hole, without uncoupling the inserts.

Electrical characteristics compliant with EN 61984:

- rated current: 10A
- rated voltage: 400V
- rated impulse withstand voltage: 6kV
- pollution degree: 3

The new inserts are available in **standard versions with silver plated brass contacts** and can be used within a temperature range of -40 °C/+125 °C.

The insertion of the screwdriver is facilitated by the particular shape of the hole, which ensures that the operation is always performed correctly.

It is possible to insert in the front area the new CR CDS coding pin that enables the polarisation of inserts in a wide range of combinations.

This means that it is possible to install side by side identical connectors with different functions.

The new CR CDS coding pins can also be used in combination with other CR 20 / CRM / CRF / CR 72 metal pins instead of insert fixing screws in order to increase the number of possible combinations.

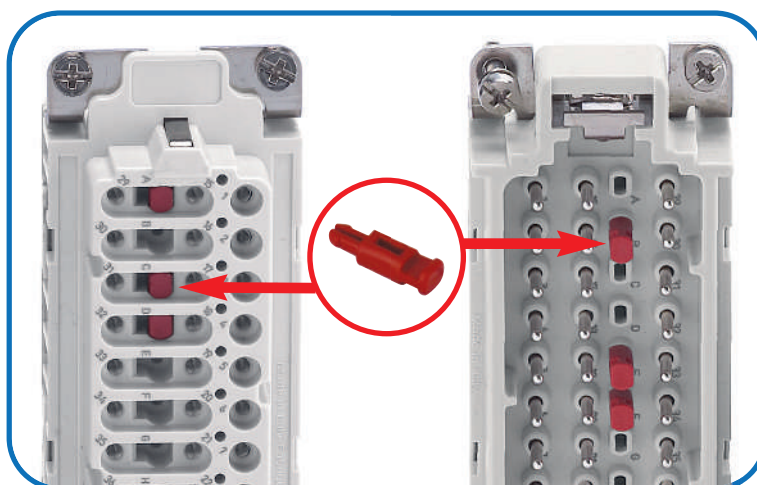

Each position of the coding pin used on the female insert must correspond to an unused position on the male insert.

The required number of coding pins, depending on the size of connectors, and the maximum number of possible codings is shown in the following table.

CDS series - Coding with CR CDS pins

Size of connectors	Slots for coding pins (M) = male insert (F) = female insert	Required coding pins for each coupling	Possible codings
9P+⊕	3 (M) + 3 (F)	3	$2^3 - 2^{(*)} = 6$
18P+⊕	6 (M) + 3 (F)	6	$2^6 - 2 = 62$
27P+⊕	9 (M) + 9 (F)	9	$2^9 - 2 = 510$
42P+⊕	14 (M) + 14 (F)	14	$2^{14} - 2 = 16.382$

(*) This excludes the two codings where all the coding pins are on one side only (male or female insert) because they are ineffective.

spring connection contacts

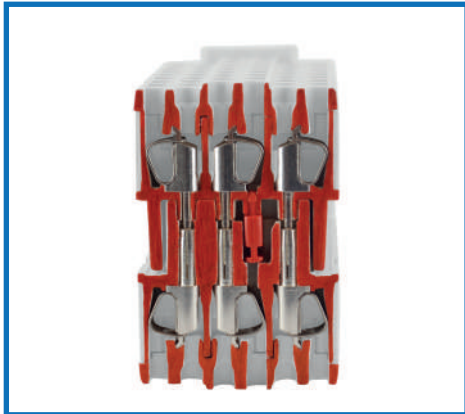

description

inserts series: JDS

- In this layout the wires are connected to the female and male insert contacts by means of a spring terminal. This type of connection offers the following advantages:
- no special wire preparation
 - a screwdriver with a 0,5 x 3,5 mm blade is the only tool required to insert the wire in the contact
 - offers an excellent fastening solution and a great resistance to strong vibrations
 - allows rigid and flexible wires with sections between 0,14 and 2,5 mm² to be used (both with non-prepared conductors and those prepared with ferrule)
 - allows conductivity tests under load to be carried out through the screwdriver insertion section, without splitting the insert
 - greatly reduces insert preparation and cabling times.

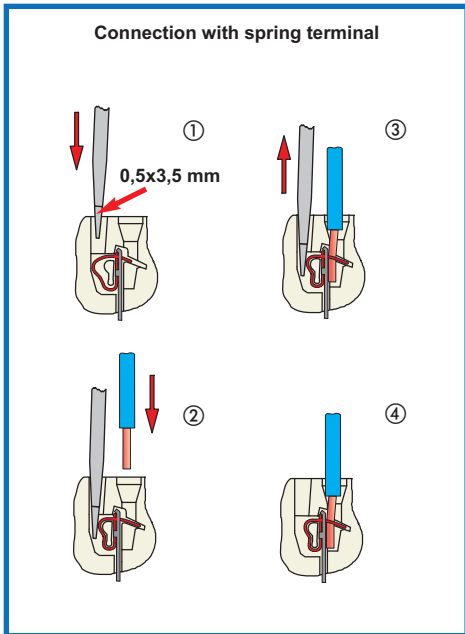

inserts series		JDS
No. of poles ¹⁾	main contacts + ⊕	9, 18, 27, 42, (54), (84)
	auxiliary contacts	--
rated current ²⁾		10A
EN 61984 pollution degree 3	rated voltage	400V
	rated impulse withstand voltage	6kV
	pollution degree	3
EN 61984 pollution degree 2	rated voltage	400V/690V
	rated impulse withstand voltage	6kV
	pollution degree	2
contact resistance		≤ 1 mΩ
insulation resistance		≥ 10 GΩ
ambient temperature limit (°C)	min	-40
	max	+125
degree of protection	with enclosures	IP65, IP66 (according to type)
	without enclosures	IP20
conductor connections		spring
conductor cross-section	mm ²	0,14 - 2,5 (for wires with crimped ferrule, usable section: up to 1,5 mm ² (AWG 16))
	AWG	26 - 14
mechanical endurance (rating cycles)		≥ 200

1) Polarities shown in brackets may be achieved by using two inserts in their own double housings.
 2) Please check the insert load curves to establish the actual maximum operating current according to the ambient temperature.

enclosures:

size "44.27"

page:

JEI®-P thermoplastic lever 92 - 93

JEI®-V zinc-plated steel lever 102 - 104

T-TYPE IP65 insulating 134 - 135

panel supports:

page:

COB 143 - 144

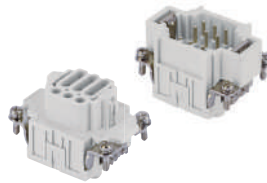
**inserts,
spring terminal connections**

 tin plated
contacts

description

part No.

spring terminal

female inserts with female contacts

male inserts with male contacts

JDSF 09
JDSM 09

- characteristics according to EN 61984:

10A 400V 6kV 3

- certifications: UL, EAC

 - insulation resistance: $\geq 10 \text{ G}\Omega$

 - ambient temperature limit: $-40 \text{ }^\circ\text{C} \dots +125 \text{ }^\circ\text{C}$

- made of self-extinguishing thermoplastic resin UL 94 V0

 - mechanical life: ≥ 200 cycles

 - contact resistance: $\leq 1 \text{ m}\Omega$

dimensions in mm

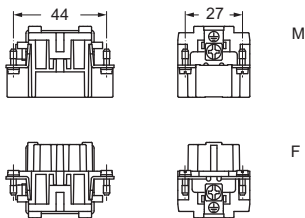

contacts side (front view)

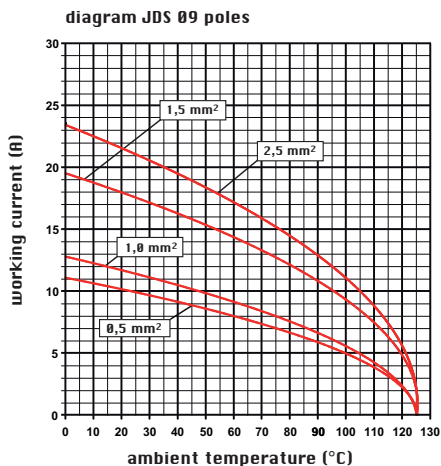
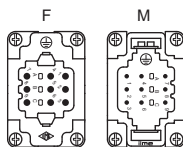

- inserts for conductors section:

 0,14 - 2,5 mm² - AWG 26 - 14

- for wires with crimped ferrule, usable section:

 up to 1,5 mm² (AWG 16)

- conductors stripping length: 9...11 mm *

* the stripping length for prepared wires with bush crimped depends on that of the bush itself

CR CDS coding pin

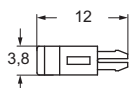
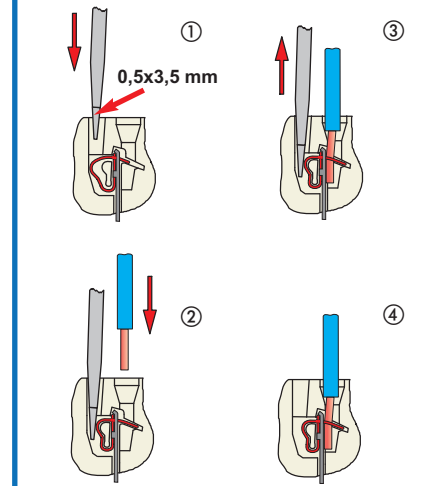
Connection with spring terminal

 dimensions shown are not binding
and may be changed without notice

enclosures:

size "57.27"

page:

JEI®-P thermoplastic lever 94 - 95

JEI®-V zinc-plated steel lever 105 - 109

T-TYPE IP65 insulating 136 - 137

panel supports:

page:

COB 143 - 144

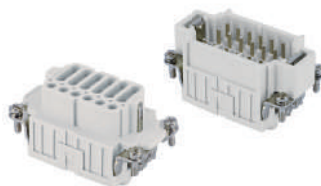
**inserts,
spring terminal connections**

 tin plated
contacts

description

part No.

spring terminal

female inserts with female contacts

male inserts with male contacts

JDSF 18
JDSM 18

- characteristics according to EN 61984:

10A 400V 6kV 3

- certifications: UL, EAC

 - insulation resistance: $\geq 10 \text{ G}\Omega$

 - ambient temperature limit: $-40 \text{ }^\circ\text{C} \dots +125 \text{ }^\circ\text{C}$

- made of self-extinguishing thermoplastic resin UL 94 V0

 - mechanical life: ≥ 200 cycles

 - contact resistance: $\leq 1 \text{ m}\Omega$

dimensions in mm

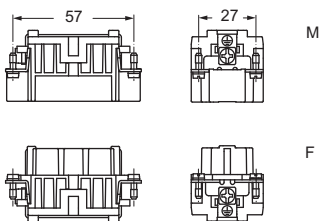

contacts side (front view)

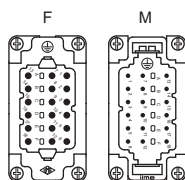
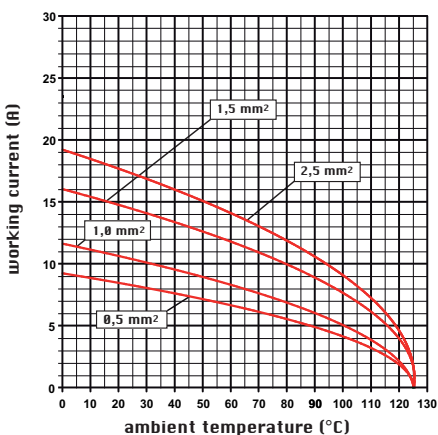

diagram JDS 18 poles



- inserts for conductors section:

 0,14 - 2,5 mm² - AWG 26 - 14

- for wires with crimped ferrule, usable section:

 up to 1,5 mm² (AWG 16)

- conductors stripping length: 9...11 mm *

* the stripping length for prepared wires with bush crimped depends on that of the bush itself

CR CDS coding pin

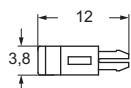
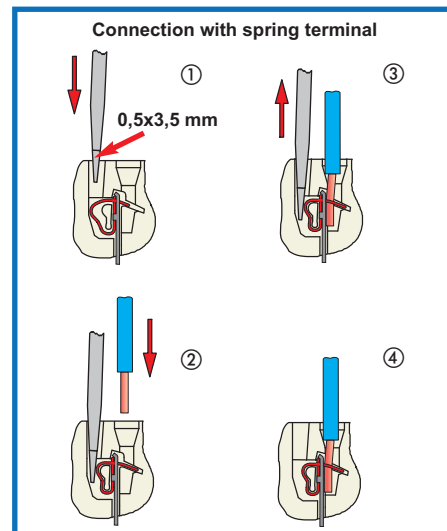
 dimensions shown are not binding
and may be changed without notice

enclosures:

size "77.27"

page:

JEI®-P thermoplastic lever 96 - 97

JEI®-V zinc-plated steel lever 110 - 114

T-TYPE IP65 insulating 138 - 139

panel supports:

page:

COB 143 - 144

inserts,
spring terminal connections



tin plated
contacts

description

part No.

spring terminal

female inserts with female contacts

male inserts with male contacts

JDSF 27

JDSM 27

- characteristics according to EN 61984:

10A 400V 6kV 3

- certifications: UL, EAC

- insulation resistance: $\geq 10 \text{ G}\Omega$

- ambient temperature limit: $-40 \text{ }^\circ\text{C} \dots +125 \text{ }^\circ\text{C}$

- made of self-extinguishing thermoplastic resin UL 94 V0

- mechanical life: ≥ 200 cycles

- contact resistance: $\leq 1 \text{ m}\Omega$

dimensions in mm

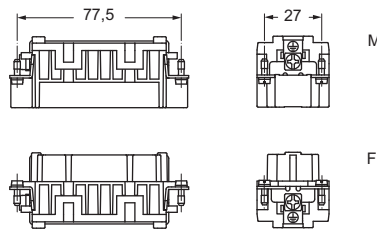

contacts side (front view)

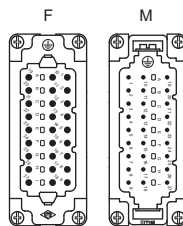
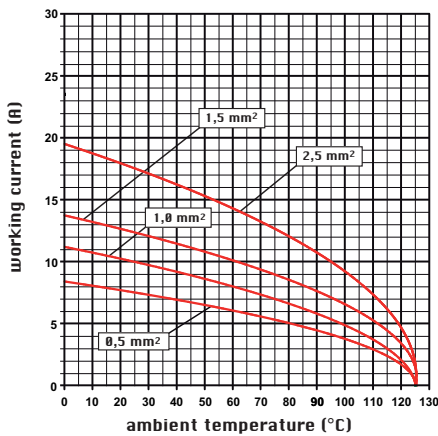

diagram JDS 27 poles



- inserts for conductors section:

0,14 - 2,5 mm² - AWG 26 - 14

- for wires with crimped ferrule, usable section:
up to 1,5 mm² (AWG 16)

- conductors stripping length: 9...11 mm *

* the stripping length for prepared wires with bush crimped depends on that of the bush itself

CR CDS coding pin

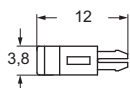

Connection with spring terminal

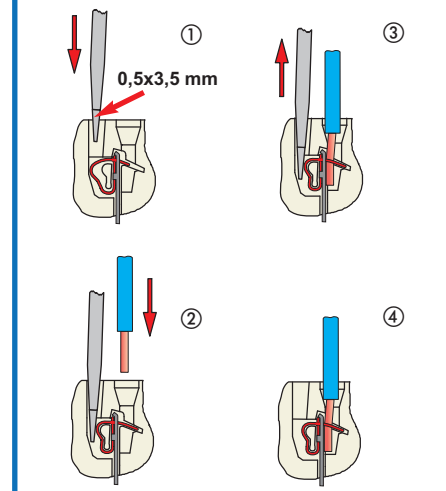

dimensions shown are not binding
and may be changed without notice

enclosures:

size "104.27"

page:

JEI®-P thermoplastic lever 98 - 99

JEI®-V zinc-plated steel lever 115 - 119

T-TYPE IP65 insulating 140 - 141

panel supports:

page:

COB 143 - 144

**inserts,
spring terminal connections**

 tin plated
contacts

description

part No.

spring terminal

female inserts with female contacts

male inserts with male contacts

JDSF 42
JDSM 42

- characteristics according to EN 61984:

10A 400V 6kV 3

- certifications: UL, EAC

 - insulation resistance: $\geq 10 \text{ G}\Omega$

 - ambient temperature limit: $-40 \text{ }^\circ\text{C} \dots +125 \text{ }^\circ\text{C}$

- made of self-extinguishing thermoplastic resin UL 94 V0

 - mechanical life: ≥ 200 cycles

 - contact resistance: $\leq 1 \text{ m}\Omega$

dimensions in mm

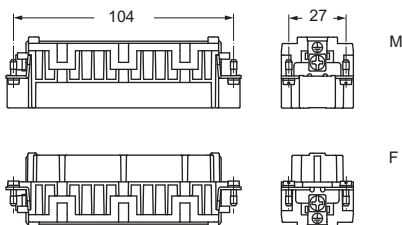

contacts side (front view)

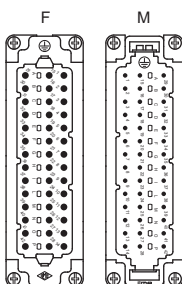
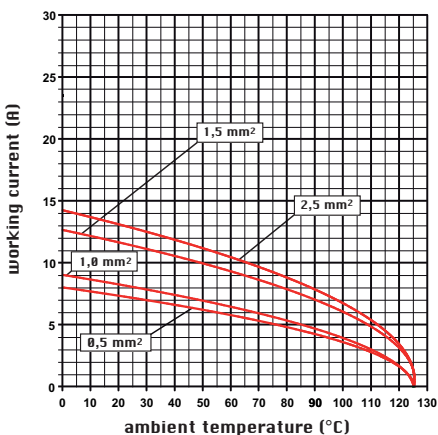

diagram JDS 42 poles



- inserts for conductors section:

 0,14 - 2,5 mm² - AWG 26 - 14

 - for wires with crimped ferrule, usable section: up to 1,5 mm² (AWG 16)

- conductors stripping length: 9...11 mm *

* the stripping length for prepared wires with bush crimped depends on that of the bush itself

CR CDS coding pin

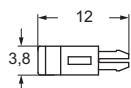
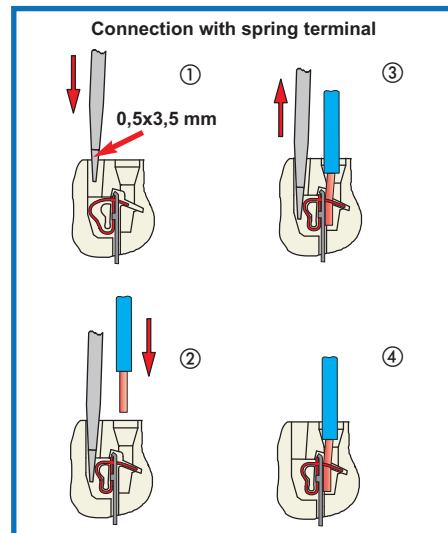
 dimensions shown are not binding
and may be changed without notice

enclosures:
size "77.62"

page:

JEI®-P thermoplastic lever 100 - 101

JEI®-V zinc-plated steel lever 120 - 121

inserts,
spring terminal connections

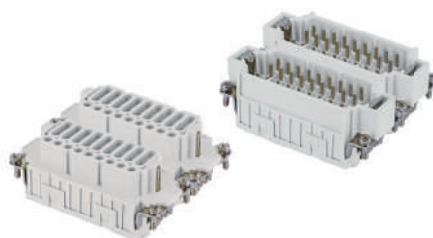

tin plated
contacts

description	part No.	part No.
spring terminal female inserts with female contacts, No. (1-27) and (28-54)	JDSF 27	JDSF 27 N
male inserts with male contacts, No. (1+27) and (28-54)	JDSM 27	JDSM 27 N

- characteristics according to EN 61984:
- 10A 400V 6kV 3**
- certifications: UL, EAC
- insulation resistance: $\geq 10 \text{ G}\Omega$
- ambient temperature limit: $-40 \text{ }^\circ\text{C} \dots +125 \text{ }^\circ\text{C}$
- made of self-extinguishing thermoplastic resin UL 94 V0
- mechanical life: ≥ 200 cycles
- contact resistance: $\leq 1 \text{ m}\Omega$

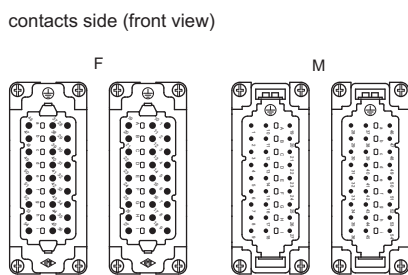
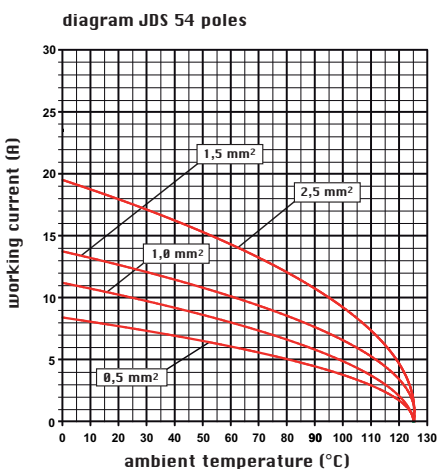
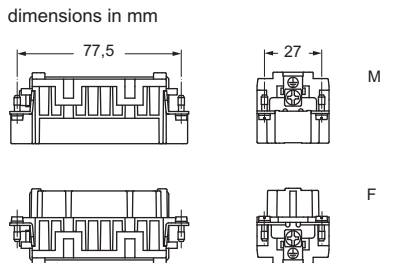

- inserts for conductors section: $0,14 - 2,5 \text{ mm}^2$ - AWG 26 - 14
- for wires with crimped ferrule, usable section: up to $1,5 \text{ mm}^2$ (AWG 16)
- conductors stripping length: $9 \dots 11 \text{ mm}^*$

* the stripping length for prepared wires with bush crimped depends on that of the bush itself

CR CDS coding pin

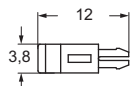

dimensions shown are not binding
and may be changed without notice

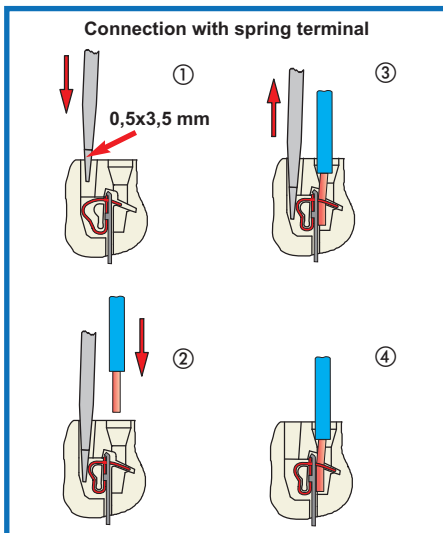

enclosures:
size "104.62"

page:

JEI®-V zinc-plated steel lever 122

inserts,
spring terminal connections

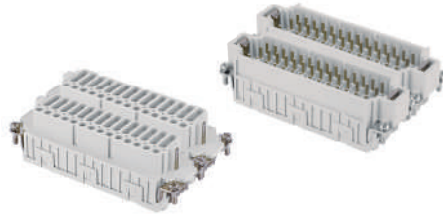

tin plated
contacts

description	part No.	part No.
spring terminal female inserts with female contacts, No. (1-42) and (43-84)	JDSF 42	JDSF 42 N
male inserts with male contacts, No.(1-42) and (43-84)	JDSM 42	JDSM 42 N

- characteristics according to EN 61984:
- 10A 400V 6kV 3**
- certifications: UL, EAC
- insulation resistance: $\geq 10 \text{ G}\Omega$
- ambient temperature limit: $-40 \text{ }^\circ\text{C} \dots +125 \text{ }^\circ\text{C}$
- made of self-extinguishing thermoplastic resin UL 94 V0
- mechanical life: ≥ 200 cycles
- contact resistance: $\leq 1 \text{ m}\Omega$

dimensions in mm

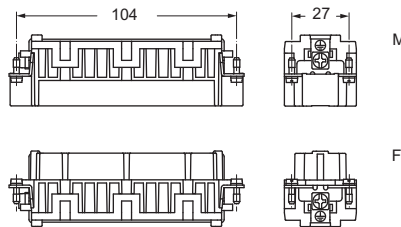
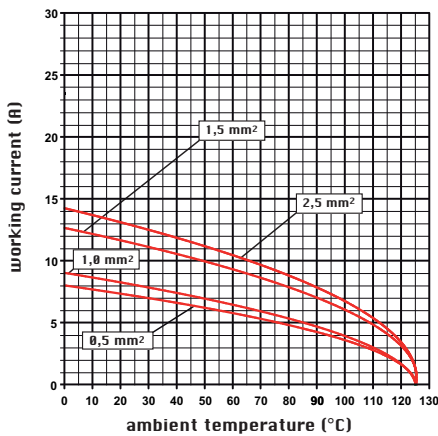
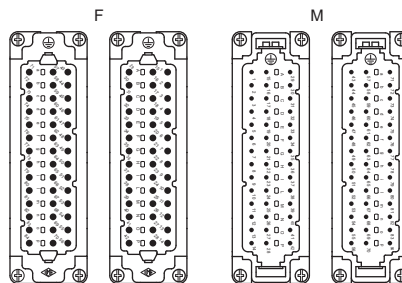

diagram JDS 84 poles



contacts side (front view)



- inserts for conductors section: 0,14 - 2,5 mm² - AWG 26 - 14
- for wires with crimped ferrule, usable section: up to 1,5 mm² (AWG 16)
- conductors stripping length: 9...11 mm *

* the stripping length for prepared wires with bush crimped depends on that of the bush itself

CR CDS coding pin

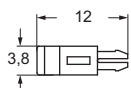

dimensions shown are not binding
and may be changed without notice

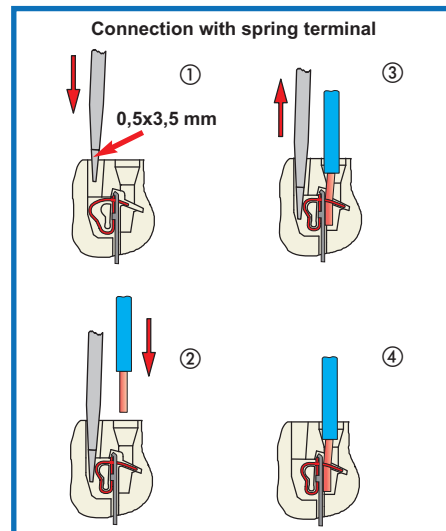

SQUICH®

Connections without tools

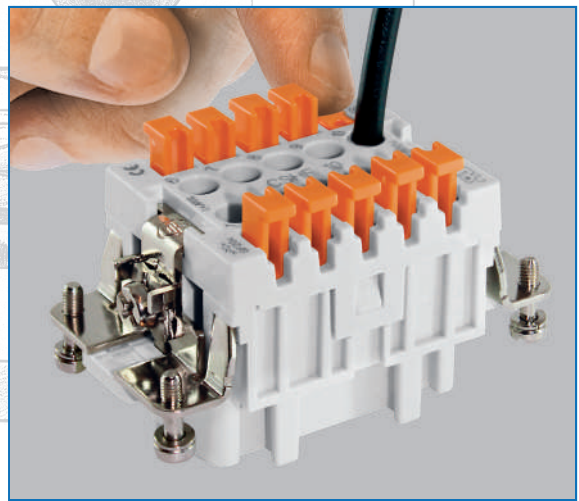
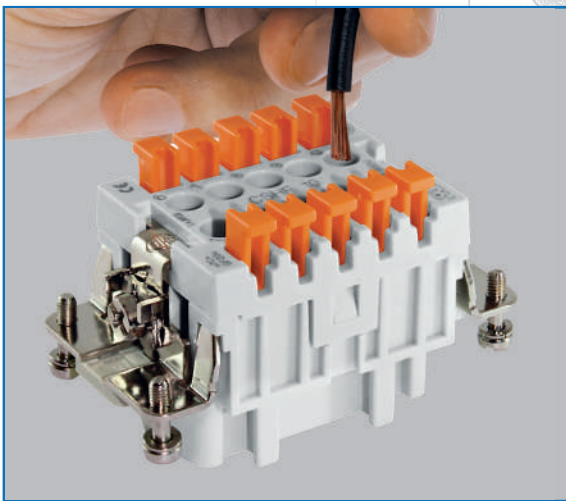

A TIMESAVER

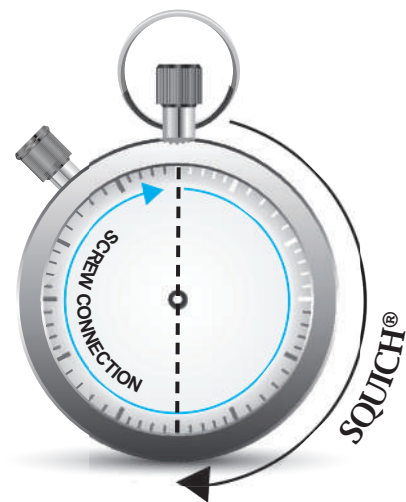
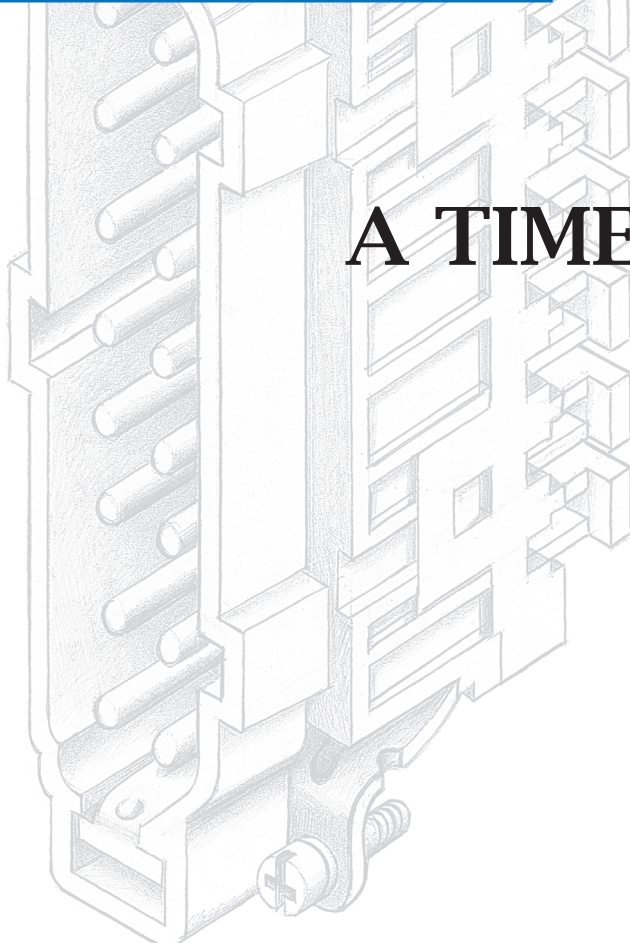

Spring connection contacts with actuator button

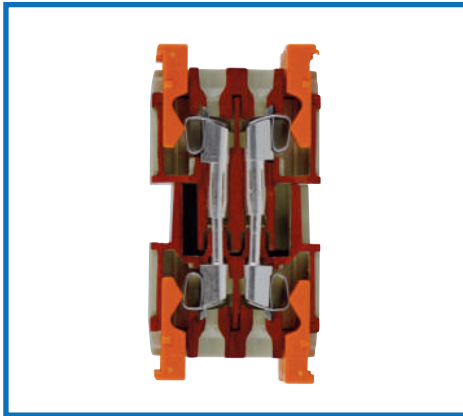

description

inserts series: JSH

in this layout the wires are connected to the socket and plug insert contacts by means of a spring terminal with actuator button.

This type of connection offers the following advantages:

- no special wire preparation (**other than stripping**)
- no cabling tool is necessary
- it offers an excellent fastening solution and a great resistance to strong vibrations
- allows rigid and flexible wires with cross-sections between 0,14 and 2,5 mm² to be used (26 - 14 AWG)
- greatly reduces insert preparation and cabling times
- a screwdriver with a 0,5 x 3,5 mm blade is the only tool required to remove the wire from the contact.

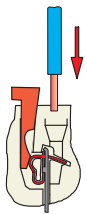

Step 1

deep insertion of the conductor (with its insulation removed) in its own round seat.

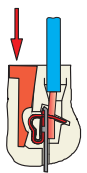

Step 2

press the actuator button to close the terminal.

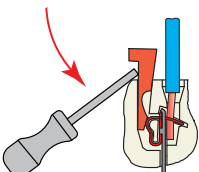

Reopening

0,5x3,5 mm

inserts series		JSH
No. of poles ¹⁾	main contact + ⊕	6, 10, 16, 24, (32), (48)
	auxiliary contacts	--
rated current ²⁾		16A
EN 61984 pollution degree 3	rated voltage	500V
	rated holding impulse withstand voltage	6kV
	pollution degree	3
EN 61984 pollution degree 2	rated voltage	400/690V
	rated holding impulse withstand voltage	6kV
	pollution degree	2
UL/CSA certification	rated voltage (a.c./d.c.)	600V
contact resistance		≤ 3 mΩ
insulation resistance		≥ 10 GΩ
ambient temperature limit (°C)	min	-40
	max	+125
degree of protection	with enclosures	IP65, IP66 (according to type)
	without enclosures	IP20
conductor connections		spring and clamp with actuator button
conductor cross-section	mm ²	0,14 - 2,5
	AWG	26 ÷ 14
mechanical endurance (mating cycles)		≥200

1) Polarities shown in brackets may be achieved by using two inserts in their own double housings.

2) Please check the insert load curves to establish the actual maximum operating current according to the ambient temperature.

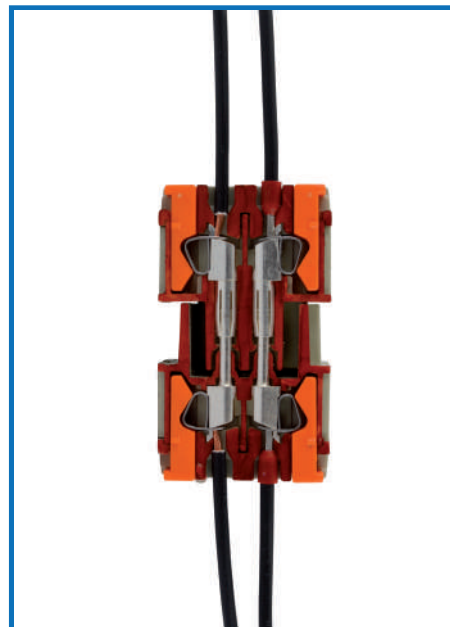

enclosures:

size "44.27"

page:

JEI®-P thermoplastic lever 92 - 93

JEI®-V zinc-plated steel lever 102 - 104

T-TYPE IP65 insulating 134 - 135

panel supports:

page:

COB 143 - 144

inserts,
spring terminal connections



tin plated
contacts

description

part No.

spring terminals with actuator button
female inserts with female contacts
male inserts with male contacts

JSHF 06
JSHM 06

- characteristics according to EN 61984:

16A 500V 6kV 3

16A 400/690V 6kV 2

- certifications: UL, EAC

- insulation resistance: $\geq 10 \text{ G}\Omega$

- ambient temperature limit: $-40 \text{ }^\circ\text{C} \dots +125 \text{ }^\circ\text{C}$

- are made of self-extinguishing thermoplastic resin
UL 94 V0

- mechanical life: ≥ 200 cycles

- contact resistance: $\leq 3 \text{ m}\Omega$

- for maximum current load, see the following load
curves inserts

dimensions in mm

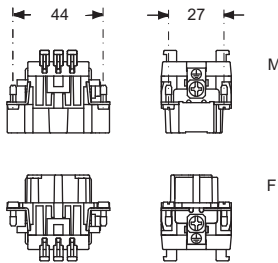

contacts side (front view)

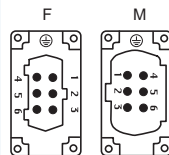

- inserts for connectors with the following sections:

0,14 - 2,5 mm² - AWG 26 - 14

- conductors stripping length: 9...11 mm *

* the stripping length for prepared wires with bush
crimped depends on that of the bush itself

diagram JSH 06 poles

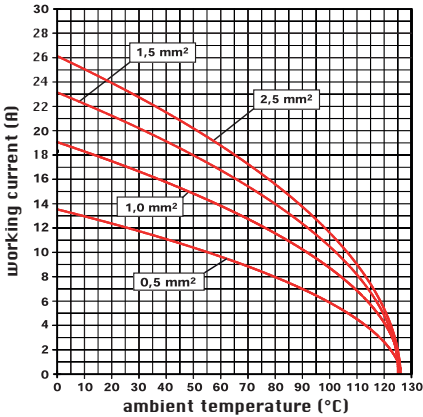

dimensions shown are not binding
and may be changed without notice

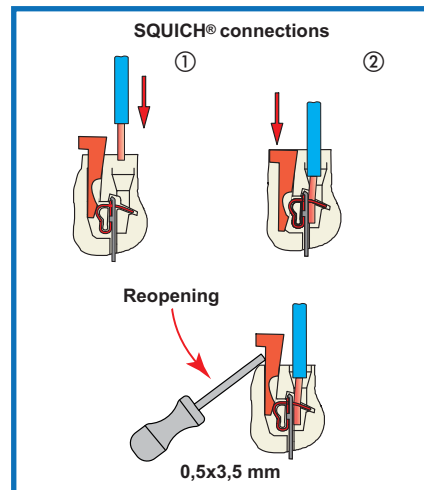

enclosures:

size "57.27"

page:

JEI®-P thermoplastic lever 94 - 95

JEI®-V zinc-plated steel lever 105 - 109

T-TYPE IP65 insulating 136 - 137

panel supports:

page:

COB 143 - 144

**inserts,
spring terminal connections**

 tin plated
contacts

description

part No.

 spring terminals with actuator button
female inserts with female contacts
male inserts with male contacts

JSHF 10
JSHM 10

- characteristics according to EN 61984:

16A 500V 6kV 3
16A 400/690V 6kV 2

- certifications: UL, EAC

 - insulation resistance: $\geq 10 \text{ G}\Omega$

 - ambient temperature limit: $-40 \text{ }^\circ\text{C} \dots +125 \text{ }^\circ\text{C}$

 - are made of self-extinguishing thermoplastic resin
UL 94 V0

 - mechanical life: ≥ 200 cycles

 - contact resistance: $\leq 3 \text{ m}\Omega$

 - for maximum current load, see the following load
curves inserts

dimensions in mm

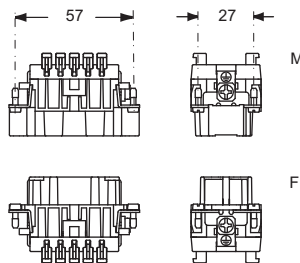

contacts side (front view)

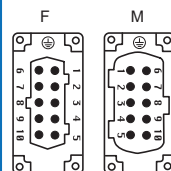

- inserts for connectors with the following sections:

 0,14 - 2,5 mm² - AWG 26 - 14

- conductors stripping length: 9...11 mm *

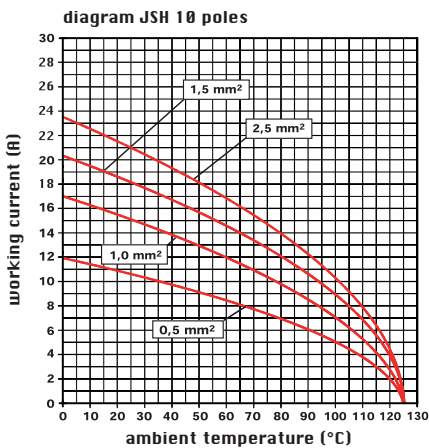
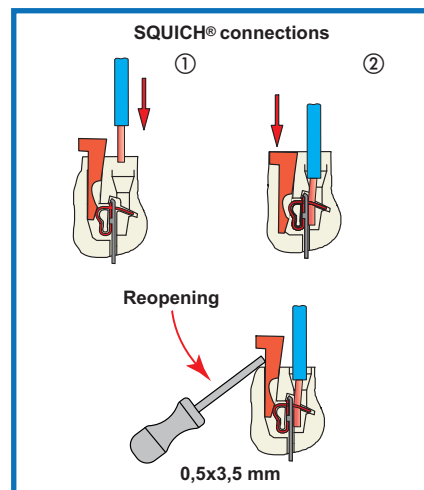
 * the stripping length for prepared wires with bush
crimped depends on that of the bush itself

 dimensions shown are not binding
and may be changed without notice

enclosures:

size "77.27"

page:

JEI®-P thermoplastic lever 96 - 97

JEI®-V zinc-plated steel lever 110 - 114

T-TYPE IP65 insulating 138 - 139

panel supports:

page:

COB 143 - 144

**inserts,
spring terminal connections**

 tin plated
contacts

description

part No.

 spring terminals with actuator button
female inserts with female contacts
male inserts with male contacts

JSHF 16
JSHM 16

- characteristics according to EN 61984:

16A 500V 6kV 3
16A 400/690V 6kV 2

- certifications: UL, EAC

 - insulation resistance: $\geq 10 \text{ G}\Omega$

 - ambient temperature limit: $-40 \text{ }^\circ\text{C} \dots +125 \text{ }^\circ\text{C}$

 - are made of self-extinguishing thermoplastic resin
UL 94 V0

 - mechanical life: ≥ 200 cycles

 - contact resistance: $\leq 3 \text{ m}\Omega$

 - for maximum current load, see the following load
curves inserts

dimensions in mm

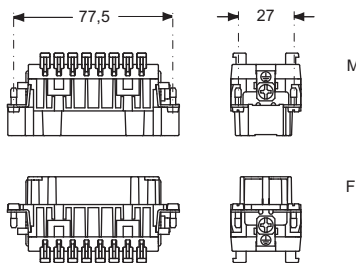

contacts side (front view)

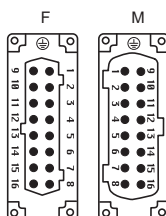

- inserts for connectors with the following sections:

 0,14 - 2,5 mm² - AWG 26 - 14

- conductors stripping length: 9...11 mm *

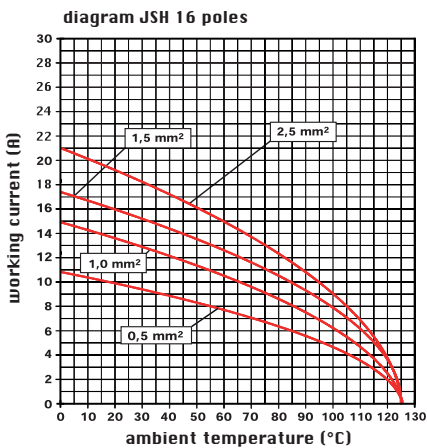
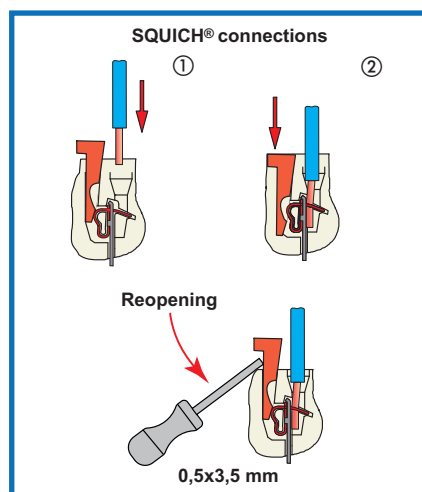
 * the stripping length for prepared wires with bush
crimped depends on that of the bush itself

 dimensions shown are not binding
and may be changed without notice

enclosures:

size "104.27"

page:

JEI®-P thermoplastic lever 98 - 99

JEI®-V zinc-plated steel lever 115 - 119

T-TYPE IP65 insulating 140 - 141

panel supports:

page:

COB 143 - 144

**inserts,
spring terminal connections**

 tin plated
contacts

description

part No.

 spring terminals with actuator button
female inserts with female contacts
male inserts with male contacts

JSHF 24
JSHM 24

- characteristics according to EN 61984:

16A 500V 6kV 3
16A 400/690V 6kV 2

- certifications: UL, EAC

 - insulation resistance: $\geq 10 \text{ G}\Omega$

 - ambient temperature limit: $-40 \text{ }^\circ\text{C} \dots +125 \text{ }^\circ\text{C}$

 - are made of self-extinguishing thermoplastic resin
UL 94 V0

 - mechanical life: ≥ 200 cycles

 - contact resistance: $\leq 3 \text{ m}\Omega$

 - for maximum current load, see the following load
curves inserts

dimensions in mm

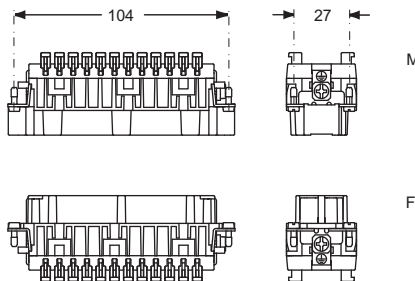

contacts side (front view)

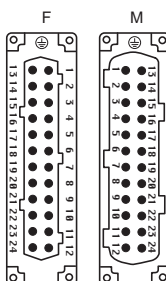

- inserts for connectors with the following sections:

 0,14 - 2,5 mm² - AWG 26 - 14

- conductors stripping length: 9...11 mm *

 * the stripping length for prepared wires with bush
crimped depends on that of the bush itself

diagram JSH 24 poles

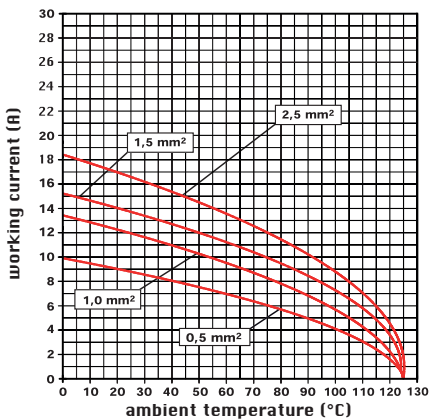
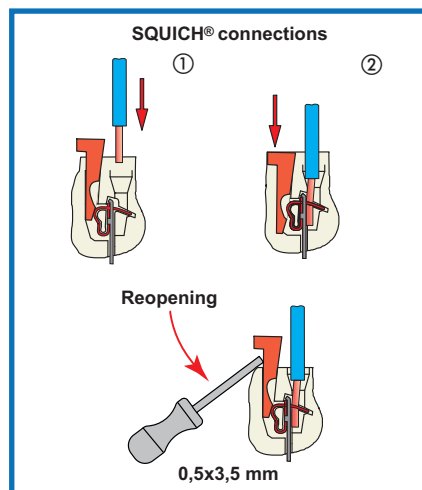

 dimensions shown are not binding
and may be changed without notice

enclosures:
size "77.62"

page:

JEI®-P thermoplastic lever 100 - 101
JEI®-V zinc-plated steel lever 120 - 121

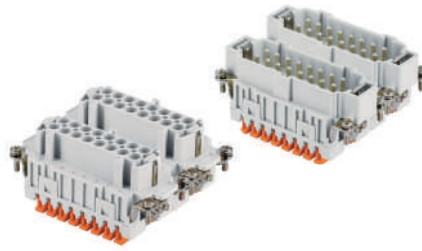
inserts,
spring terminal connections



tin plated
contacts

description	part No.	part No.
spring terminals with actuator button female inserts with female contacts, No. (1-16) and (17-32) male inserts with male contacts, No. (1-16) and (17-32)	JSHF 16 JSHM 16	JSHF 16 N JSHM 16 N

- characteristics according to EN 61984:
16A 500V 6kV 3
16A 400/690V 6kV 2
- certifications: UL, EAC
- insulation resistance: $\geq 10 \text{ G}\Omega$
- ambient temperature limit: $-40 \text{ }^\circ\text{C} \dots +125 \text{ }^\circ\text{C}$
- are made of self-extinguishing thermoplastic resin
UL 94 V0
- mechanical life: ≥ 200 cycles
- contact resistance: $\leq 3 \text{ m}\Omega$
- for maximum current load, see the following load
curves inserts

dimensions in mm

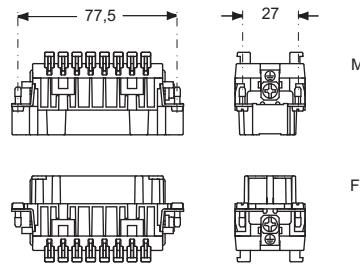

contacts side (front view)

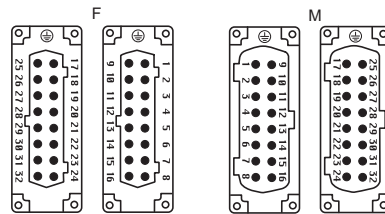

- inserts for connectors with the following sections:
0,14 - 2,5 mm² - AWG 26 - 14
- conductors stripping length: 9...11 mm *

* the stripping length for prepared wires with bush
crimped depends on that of the bush itself

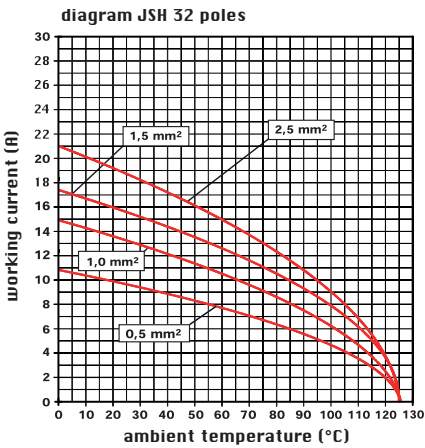

dimensions shown are not binding
and may be changed without notice

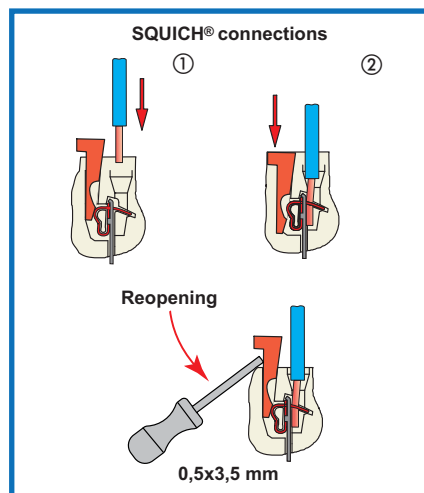

enclosures:
size "104.62"

page:

JEI®-V zinc-plated steel lever 122

inserts,
spring terminal connections

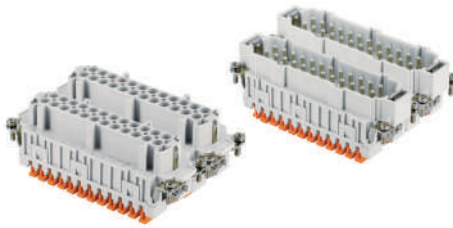

tin plated contacts

description	part No.	part No.
spring terminals with actuator button	JSHF 24	JSHF 24 N
female inserts with female contacts, No. (1-24) and (25-48)	JSHM 24	JSHM 24 N
male inserts with male contacts, No. (1-24) and (25-48)		

- characteristics according to EN 61984:
16A 500V 6kV 3
16A 400/690V 6kV 2
- certifications: UL, EAC
- insulation resistance: $\geq 10 \text{ G}\Omega$
- ambient temperature limit: $-40 \text{ }^\circ\text{C} \dots +125 \text{ }^\circ\text{C}$
- are made of self-extinguishing thermoplastic resin UL 94 V0
- mechanical life: ≥ 200 cycles
- contact resistance: $\leq 3 \text{ m}\Omega$
- for maximum current load, see the following load curves inserts

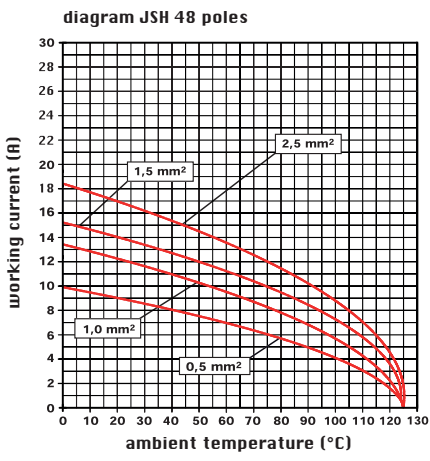
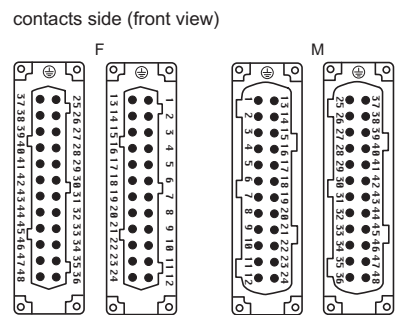
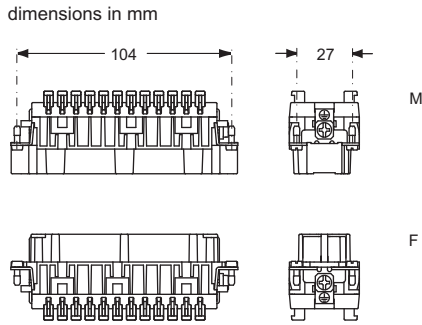

- inserts for connectors with the following sections: 0,14 - 2,5 mm² - AWG 26 - 14
- conductors stripping length: 9...11 mm *
- * the stripping length for prepared wires with bush crimped depends on that of the bush itself

dimensions shown are not binding and may be changed without notice

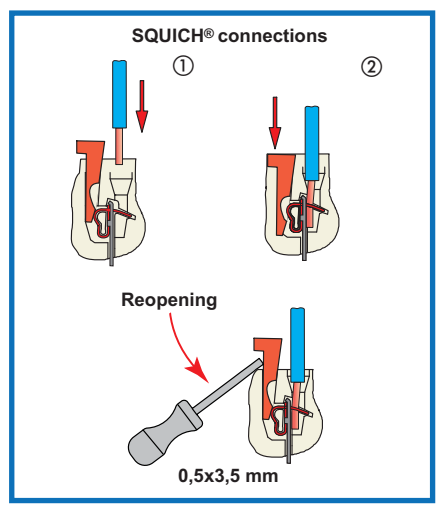

enclosures:

size "44.27"

page:

JEI®-P thermoplastic lever 92 - 93

JEI®-V zinc-plated steel lever 102 - 104

T-TYPE IP65 insulating 134 - 135

panel supports:

page:

COB 143 - 144

inserts,
screw terminal connections

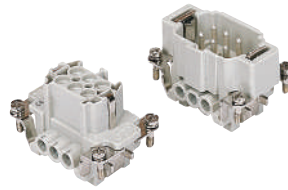

tin plated
contacts

inserts,
spring terminal connections

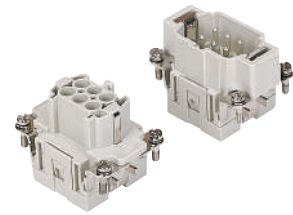

tin plated
contacts

description

part No.

part No.

indirect, with plate 1)
female inserts with female contacts
male inserts with male contacts

JNEF 06
JNEM 06

spring terminal
female inserts with female contacts
male inserts with male contacts

JSEF 06
JSEM 06

- characteristics according to EN 61984:

16A 500V 6kV 3

16A 400/690V 6kV 2

- certifications: UL, EAC

- insulation resistance: $\geq 10 \text{ G}\Omega$

- ambient temperature limit: $-40 \text{ }^\circ\text{C} \dots +125 \text{ }^\circ\text{C}$

- are made of self-extinguishing thermoplastic resin UL 94 V0

- mechanical life: ≥ 200 cycles

- contact resistance: $\leq 1 \text{ m}\Omega$ (JNE) - $\leq 3 \text{ m}\Omega$ (JSE)

- for maximum current load, see the following load curves inserts

dimensions in mm

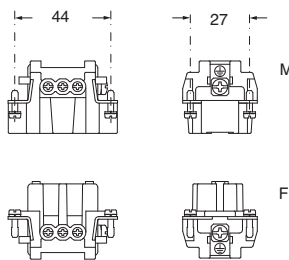

contacts side (front view)

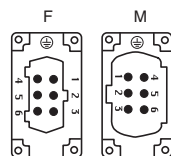

- inserts with plate for section conductors:
0,5 - 4 mm² - AWG 20 - 12
- conductors stripping length: 7 mm
- terminal screw torque: 0,5 Nm, for more information see page 19

dimensions in mm

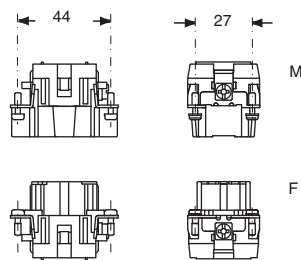

contacts side (front view)

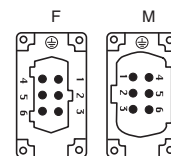

- inserts for section conductors:
0,14 - 2,5 mm² - AWG 26 - 14
- conductors stripping length: 9...11 mm *

* the stripping length for prepared wires with bush crimped depends on that of the bush itself

diagram JNE 06 poles

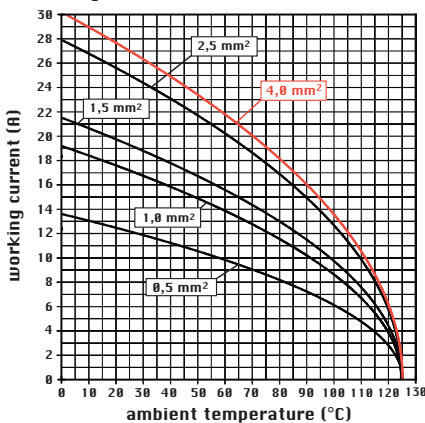
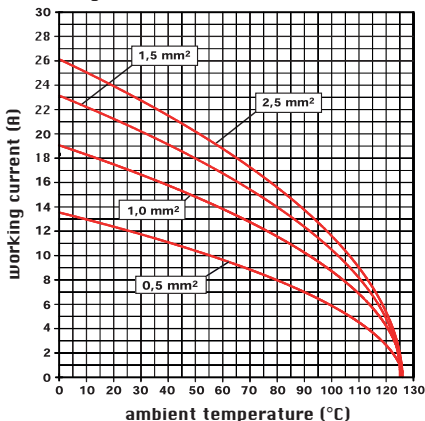
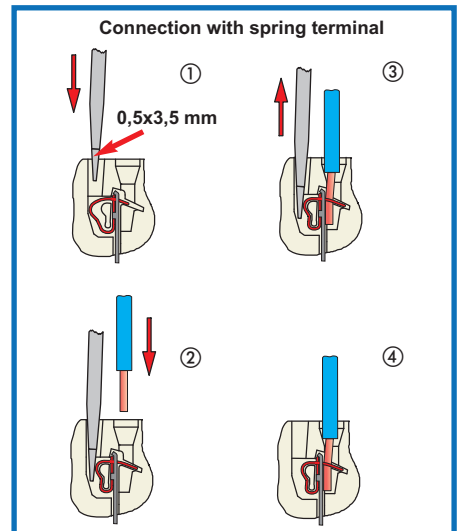
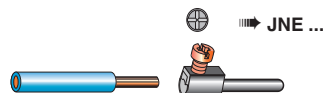

diagram JSE 06 poles



dimensions shown are not binding
and may be changed without notice

1) for non-prepared conductors



enclosures:

size "57.27"

page:

JEI®-P thermoplastic lever 94 - 95

JEI®-V zinc-plated steel lever 105 - 109

T-TYPE IP65 insulating 136 - 137

panel supports:

page:

COB 143 - 144

inserts,
screw terminal connections

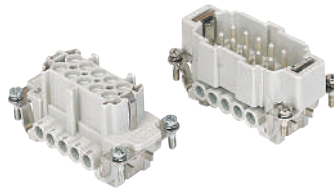

tin plated
contacts

inserts,
spring terminal connections

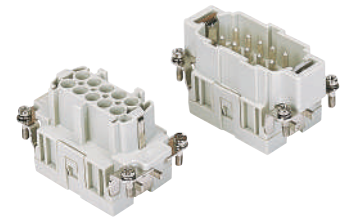

tin plated
contacts

description

part No.

part No.

indirect, with plate 1)
female inserts with female contacts
male inserts with male contacts

JNEF 10
JNEM 10

spring terminal
female inserts with female contacts
male inserts with male contacts

JSEF 10
JSEM 10

- characteristics according to EN 61984:

16A 500V 6kV 3

16A 400/690V 6kV 2

- certifications: UL, EAC

- insulation resistance: $\geq 10 \text{ G}\Omega$

- ambient temperature limit: $-40 \text{ }^\circ\text{C} \dots +125 \text{ }^\circ\text{C}$

- are made of self-extinguishing thermoplastic resin UL 94 V0

- mechanical life: ≥ 200 cycles

- contact resistance: $\leq 1 \text{ m}\Omega$ (JNE) - $\leq 3 \text{ m}\Omega$ (JSE)

- for maximum current load, see the following load curves inserts

dimensions in mm

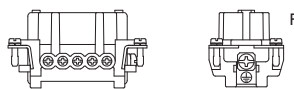
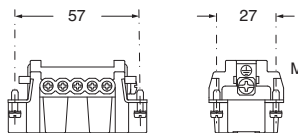

contacts side (front view)

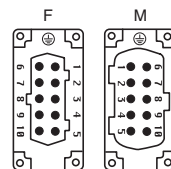

- inserts with plate for section conductors: 0,5 - 4 mm² - AWG 20 - 12
- conductors stripping length: 7 mm
- terminal screw torque: 0,5 Nm, for more information see page 19

dimensions in mm

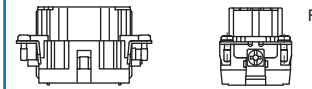
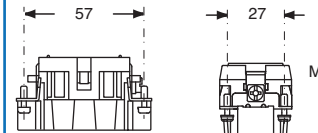

contacts side (front view)

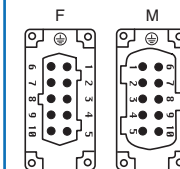

- inserts for section conductors: 0,14 - 2,5 mm² - AWG 26 - 14
- conductors stripping length: 9...11 mm *

* the stripping length for prepared wires with bush crimped depends on that of the bush itself

diagram JNE 10 poles

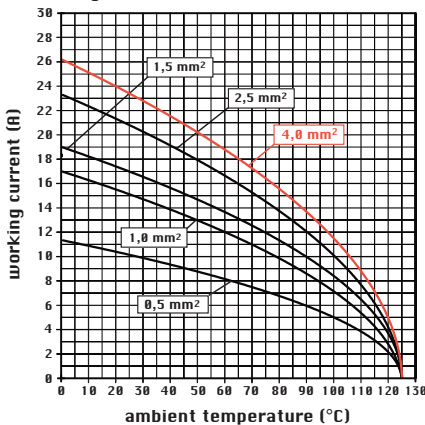
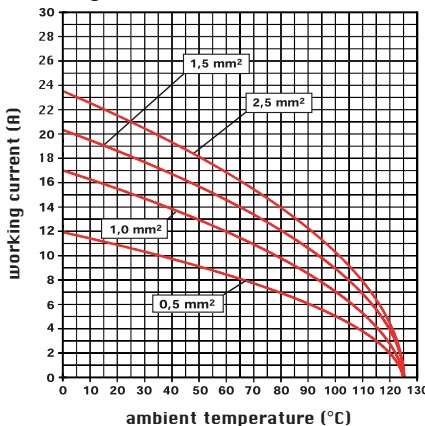
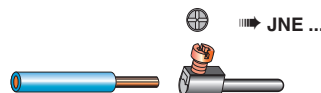

diagram JSE 10 poles



dimensions shown are not binding
and may be changed without notice

1) for non-prepared conductors



Connection with spring terminal

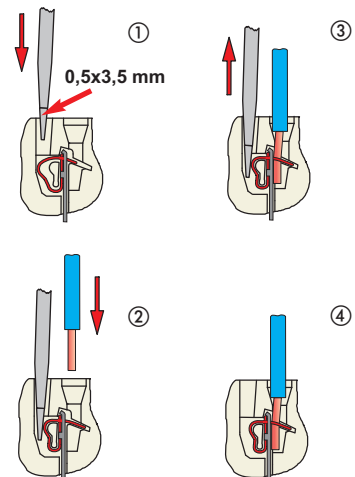

enclosures:

size "77.27"

page:

JEI®-P thermoplastic lever 96 - 97

JEI®-V zinc-plated steel lever 110 - 114

T-TYPE IP65 insulating 138 - 139

panel supports:

page:

COB 143 - 144

inserts,
screw terminal connections

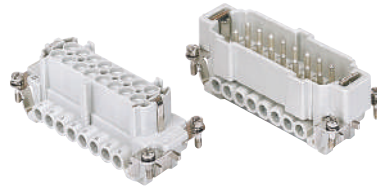

tin plated
contacts

inserts,
spring terminal connections

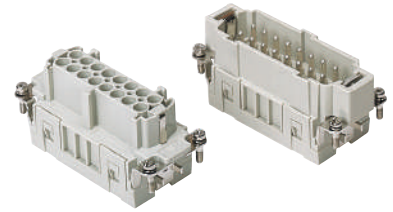

tin plated
contacts

description

part No.

part No.

indirect, with plate 1)
female inserts with female contacts
male inserts with male contacts

JNEF 16
JNEM 16

spring terminal
female inserts with female contacts
male inserts with male contacts

JSEF 16
JSEM 16

- characteristics according to EN 61984:

16A 500V 6kV 3

16A 400/690V 6kV 2

- certifications: UL, EAC

- insulation resistance: $\geq 10 \text{ G}\Omega$

- ambient temperature limit: $-40 \text{ }^\circ\text{C} \dots +125 \text{ }^\circ\text{C}$

- are made of self-extinguishing thermoplastic resin UL 94 V0

- mechanical life: ≥ 200 cycles

- contact resistance: $\leq 1 \text{ m}\Omega$ (JNE) - $\leq 3 \text{ m}\Omega$ (JSE)

- for maximum current load, see the following load curves inserts

dimensions in mm

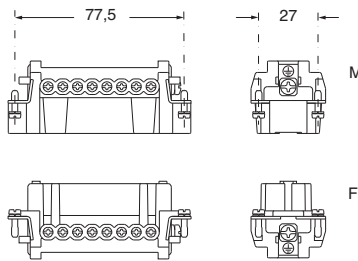

contacts side (front view)

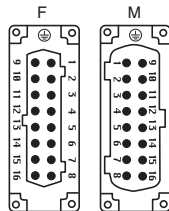

- inserts with plate for section conductors: 0,5 - 4 mm² - AWG 20 - 12
- conductors stripping length: 7 mm
- terminal screw torque: 0,5 Nm, for more information see page 19

dimensions in mm

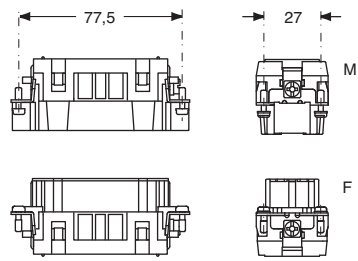

contacts side (front view)

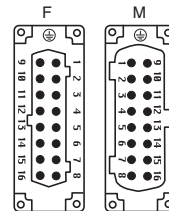

- inserts for section conductors: 0,14 - 2,5 mm² - AWG 26 - 14
- conductors stripping length: 9...11 mm *
- * the stripping length for prepared wires with bush crimped depends on that of the bush itself

diagram JNE 16 poles

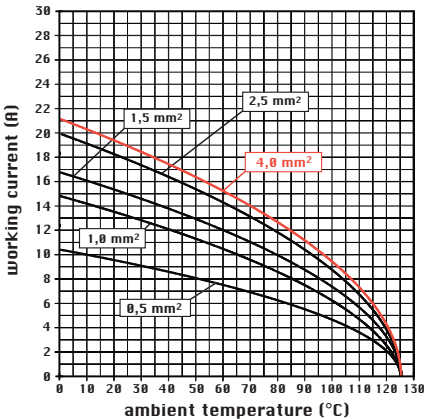
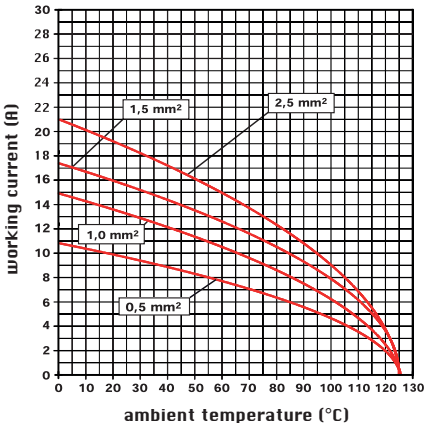
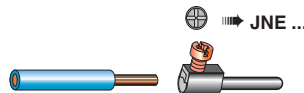

diagram JSE 16 poles



dimensions shown are not binding
and may be changed without notice

1) for non-prepared conductors



Connection with spring terminal

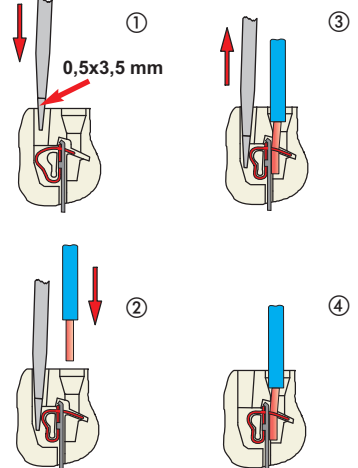

enclosures:

size "104.27" page:

JEI®-P thermoplastic lever 98 - 99

JEI®-V zinc-plated steel lever 115 - 119

T-TYPE IP65 insulating 140 - 141

panel supports:

COB 143 - 144 page:

**inserts,
screw terminal connections**

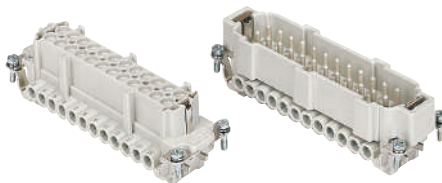

tin plated contacts

**inserts,
spring terminal connections**

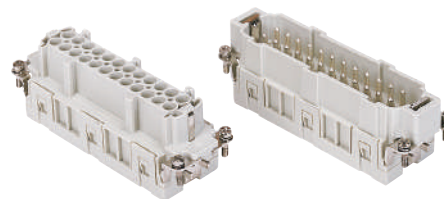

tin plated contacts

description

part No.

part No.

indirect, with plate 1)
female inserts with female contacts
male inserts with male contacts

JNEF 24
JNEM 24

spring terminal
female inserts with female contacts
male inserts with male contacts

JSEF 24
JSEM 24

- characteristics according to EN 61984:

16A 500V 6kV 3

16A 400/690V 6kV 2

- certifications: UL, EAC

- insulation resistance: $\geq 10 \text{ G}\Omega$

- ambient temperature limit: $-40 \text{ }^\circ\text{C} \dots +125 \text{ }^\circ\text{C}$

- are made of self-extinguishing thermoplastic resin UL 94 V0

- mechanical life: ≥ 200 cycles

- contact resistance: $\leq 1 \text{ m}\Omega$ (JNE) - $\leq 3 \text{ m}\Omega$ (JSE)

- for maximum current load, see the following load curves inserts

dimensions in mm

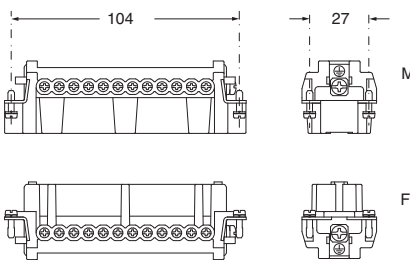

dimensions in mm

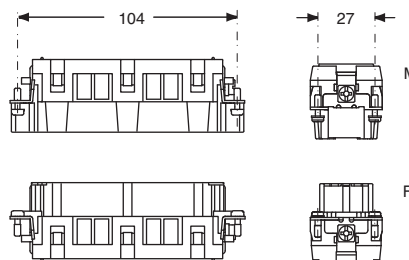
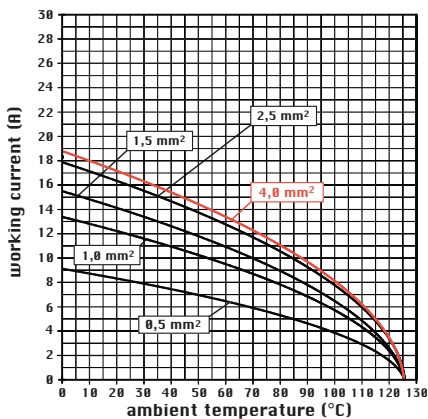
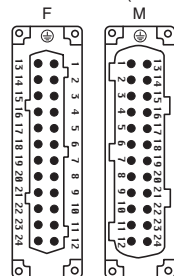

diagram JNE 24 poles



contacts side (front view)



contacts side (front view)

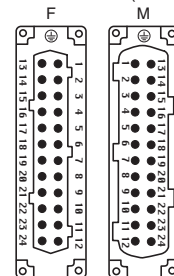

- inserts with plate for section conductors:
0,5 - 4 mm² - AWG 20 - 12

- conductors stripping length: 7 mm

- terminal screw torque: 0,5 Nm, for more information see page 19

- inserts for section conductors:
0,14 - 2,5 mm² - AWG 26 - 14

- conductors stripping length: 9...11 mm *

* the stripping length for prepared wires with bush crimped depends on that of the bush itself

diagram JSE 24 poles

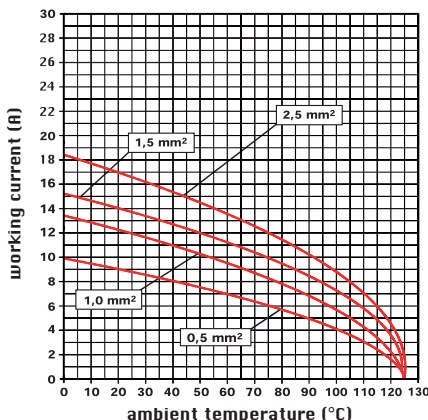

1) for non-prepared conductors

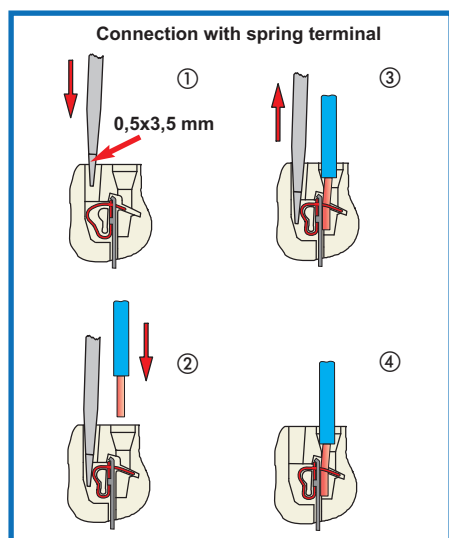
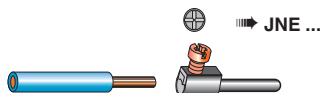

dimensions shown are not binding
and may be changed without notice

enclosures:
size "77.62"

page:

JEI®-P thermoplastic lever 100 - 101
JEI®-V zinc-plated steel lever 120 - 121

inserts,
screw terminal connections

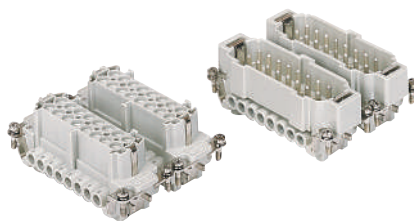

tin plated
contacts

inserts,
spring terminal connections

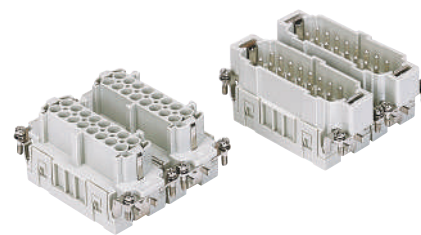

tin plated
contacts

description	part No.	part No.	part No.	part No.
-------------	----------	----------	----------	----------

indirect, with plate 1)
female inserts, No. (1-16) and (17-32)
male inserts, No. (1-16) and (17-32)

JNEF 16
JNEM 16

JNEF 16 N
JNEM 16 N

spring terminal
female inserts, No. (1-16) and (17-32)
male inserts, No. (1-16) and (17-32)

JSEF 16
JSEM 16

JSEF 16 N
JSEM 16 N

- characteristics according to EN 61984:
- 16A 500V 6kV 3**
- 16A 400/690V 6kV 2**
- certifications: UL, EAC
- insulation resistance: $\geq 10 \text{ G}\Omega$
- ambient temperature limit: $-40 \text{ }^\circ\text{C} \dots +125 \text{ }^\circ\text{C}$
- are made of self-extinguishing thermoplastic resin UL 94 V0
- mechanical life: ≥ 200 cycles
- contact resistance: $\leq 1 \text{ m}\Omega$ (JNE) - $\leq 3 \text{ m}\Omega$ (JSE)
- for maximum current load, see the following load curves inserts

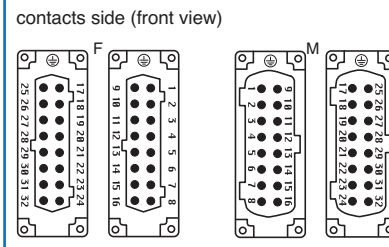
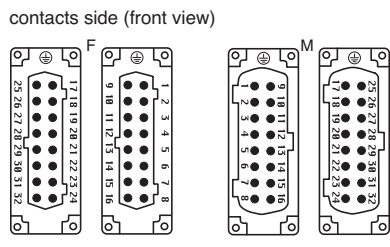
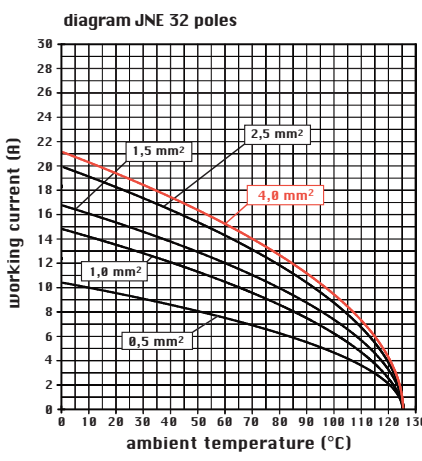
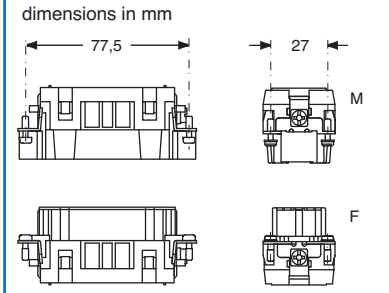
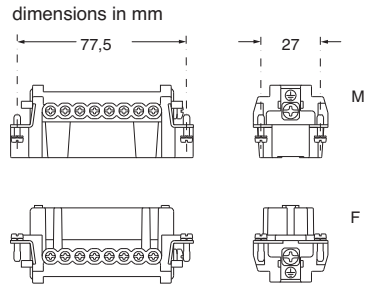

- inserts with plate for section conductors: 0,5 - 4 mm² - AWG 20 - 12
- conductors stripping length: 7 mm
- terminal screw torque: 0,5 Nm, for more information see page 19

- inserts for section conductors: 0,14 - 2,5 mm² - AWG 26 - 14
 - conductors stripping length: 9...11 mm *
- * the stripping length for prepared wires with bush crimped depends on that of the bush itself

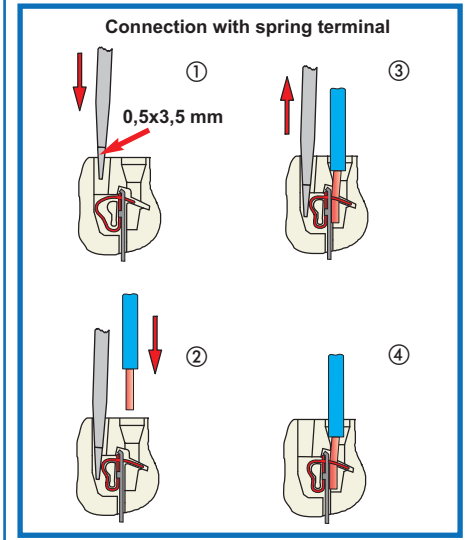
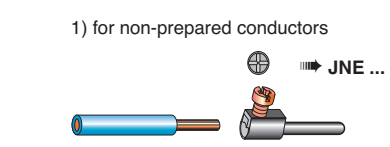
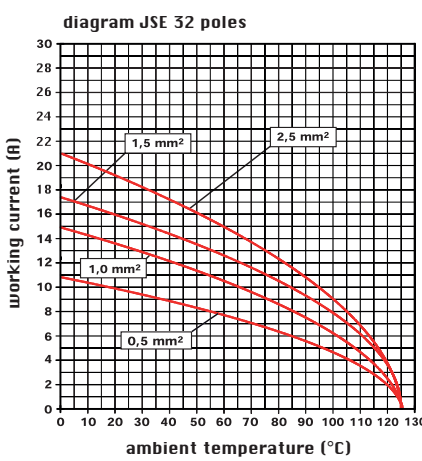

dimensions shown are not binding
and may be changed without notice

enclosures:
size "104.62"

page:

JEI®-V zinc-plated steel lever 122

inserts,
screw terminal connections

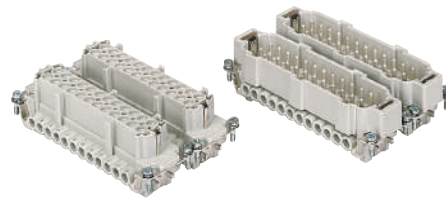

tin plated
contacts

inserts,
spring terminal connections

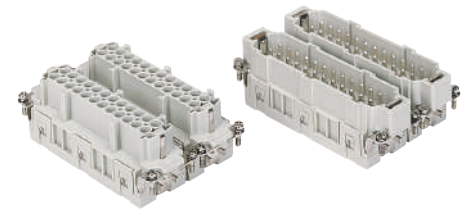

tin plated
contacts

description	part No.	part No.	part No.	part No.
-------------	----------	----------	----------	----------

indirect, with plate 1)
female inserts, No. (1-24) and (25-48)
male inserts, No. (1-24) and (25-48)

JNEF 24
JNEM 24

JNEF 24 N
JNEM 24 N

spring terminal
female inserts, No. (1-24) and (25-48)
male inserts, No. (1-24) and (25-48)

JSEF 24
JSEM 24

JSEF 24 N
JSEM 24 N

- characteristics according to EN 61984:
- 16A 500V 6kV 3**
- 16A 400/690V 6kV 2**
- certifications: UL, EAC
- insulation resistance: $\geq 10 \text{ G}\Omega$
- ambient temperature limit: $-40 \text{ }^\circ\text{C} \dots +125 \text{ }^\circ\text{C}$
- are made of self-extinguishing thermoplastic resin UL 94 V0
- mechanical life: ≥ 200 cycles
- contact resistance: $\leq 1 \text{ m}\Omega$ (JNE) - $\leq 3 \text{ m}\Omega$ (JSE)
- for maximum current load, see the following load curves inserts

dimensions in mm

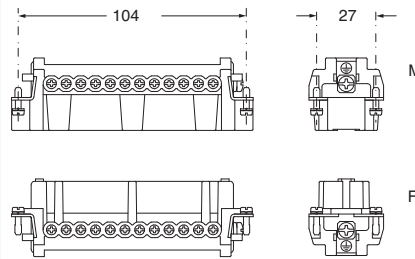

dimensions in mm

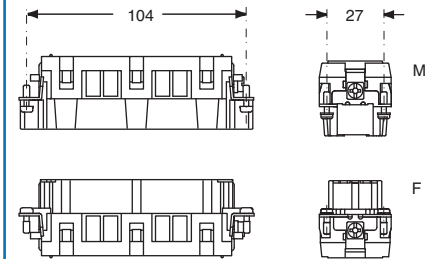

contacts side (front view)

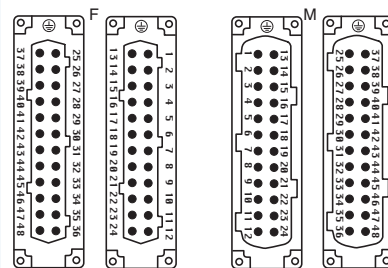

contacts side (front view)

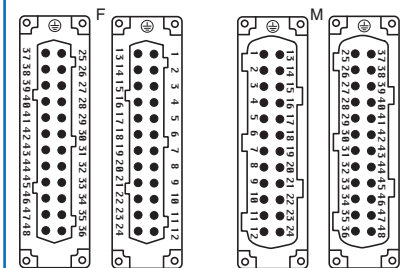

- inserts with plate for section conductors: 0.5 - 4 mm² - AWG 20 - 12
- conductors stripping length: 7 mm
- terminal screw torque: 0.5 Nm, for more information see page 19

- inserts for section conductors: 0.14 - 2.5 mm² - AWG 26 - 14
- conductors stripping length: 9...11 mm *
- * the stripping length for prepared wires with bush crimped depends on that of the bush itself

diagram JNE 48 poles

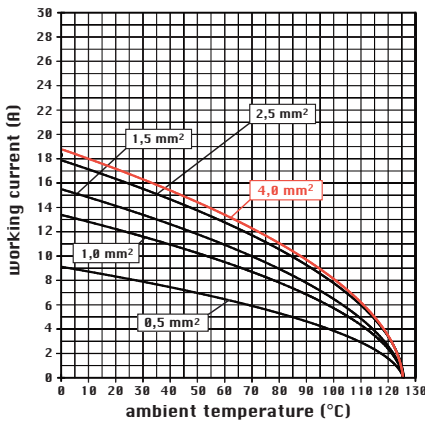
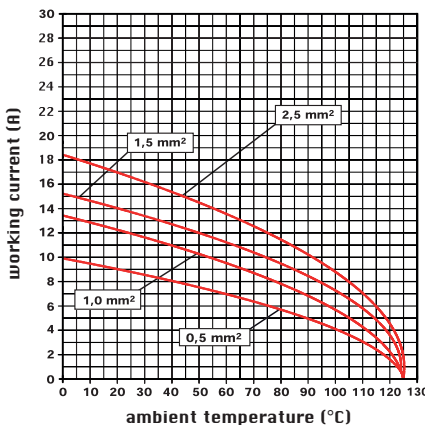
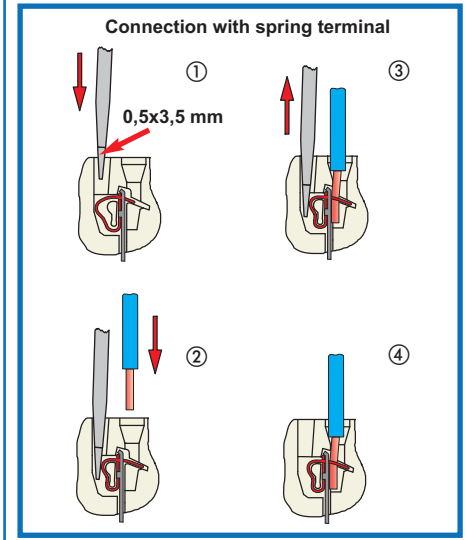
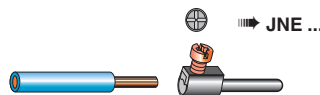

diagram JSE 48 poles



dimensions shown are not binding
and may be changed without notice

1) for non-prepared conductors



enclosures:

size "44.27"

page:

JEI®-P thermoplastic lever 92 - 93

JEI®-V zinc-plated steel lever 102 - 104

T-TYPE IP65 insulating 134 - 135

panel supports:

page:

COB 143 - 144

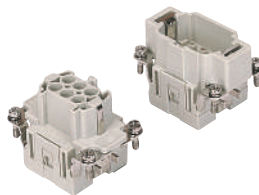
inserts, crimp connections

**16A crimp contacts
tin and gold plated**

description

part No.

part No.

part No.

without contacts (to be ordered separately)

female inserts for female contacts

male inserts for male contacts

**CCEF 06
CCEM 06**
16A female contacts

0,14-0,37 mm ²	AWG 26-22	three grooves
0,5 mm ²	AWG 20	with no grooves
0,75 mm ²	AWG 18	one groove (back side)
1 mm ²	AWG 18	one groove
1,5 mm ²	AWG 16	two grooves
2,5 mm ²	AWG 14	three grooves
3 mm ²	AWG 12	one wide groove
4 mm ²	AWG 12	with no grooves

16A male contacts

0,14-0,37 mm ²	AWG 26-22	three grooves
0,5 mm ²	AWG 20	with no grooves
0,75 mm ²	AWG 18	one groove (back side)
1 mm ²	AWG 18	one groove
1,5 mm ²	AWG 16	two grooves
2,5 mm ²	AWG 14	three grooves
3 mm ²	AWG 12	one wide groove
4 mm ²	AWG 12	with no grooves

tin plated
 CCFS 0.3
 CCFS 0.5
 CCFS 0.7
 CCFS 1.0
 CCFS 1.5
 CCFS 2.5
 CCFS 3.0
 CCFS 4.0

gold plated
 CCFJD 0.3
 CCFJD 0.5
 CCFJD 0.7
 CCFJD 1.0
 CCFJD 1.5
 CCFJD 2.5
 CCFJD 3.0
 CCFJD 4.0

 CCMS 0.3
 CCMS 0.5
 CCMS 0.7
 CCMS 1.0
 CCMS 1.5
 CCMS 2.5
 CCMS 3.0
 CCMS 4.0

 CCMJD 0.3
 CCMJD 0.5
 CCMJD 0.7
 CCMJD 1.0
 CCMJD 1.5
 CCMJD 2.5
 CCMJD 3.0
 CCMJD 4.0

- characteristics according to EN 61984:

16A 500V 6kV 3
16A 400/690V 6kV 2

- insulation resistance: $\geq 10 \text{ G}\Omega$
- ambient temperature limit: $-40 \text{ }^\circ\text{C} \dots +125 \text{ }^\circ\text{C}$
- are made of self-extinguishing thermoplastic resin UL 94 V0
- mechanical life: ≥ 200 cycles (tin plated)
- mechanical life: ≥ 500 cycles (gold plated)
- contact resistance: $\leq 1 \text{ m}\Omega$
- for contact crimping instructions, please see the crimping tool section (16A contacts, CCF, CCM series) on page 150
- for maximum current load, see the following load curves inserts, for more information see page 154

dimensions in mm

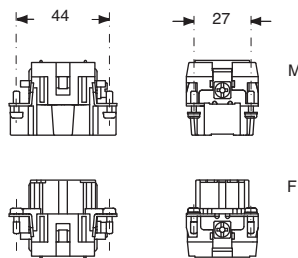

dimensions in mm

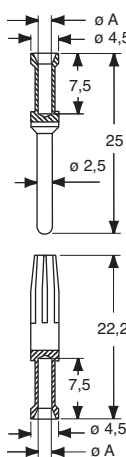
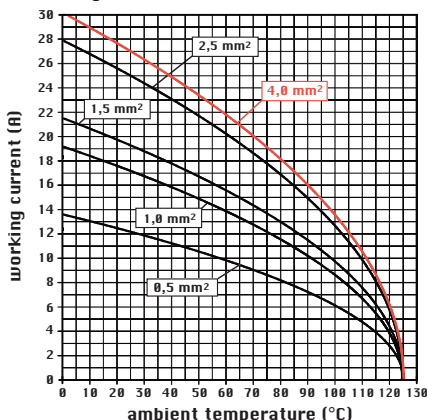
diagram CCE 06 poles

contacts side (front view)

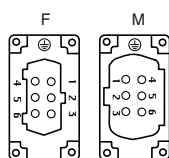

coding pin with loss of a contact CR CPQ

 dimensions shown are not binding
and may be changed without notice

CCF, CCM contacts

conductor section mm ²	conductor slot ø A (mm)	conductors stripping length (mm)
0,14-0,37	0,9	7,5
0,5	1,1	7,5
0,75	1,3	7,5
1,0	1,45	7,5
1,5	1,8	7,5
2,5	2,2	7,5
3	2,55	7,5
4	2,85	7,5

WARNING:

Do not use tin plated crimp contacts coupled with gold plated crimp contacts.

enclosures:

size "57.27"

page:

JEI®-P thermoplastic lever 94 - 95

JEI®-V zinc-plated steel lever 105 - 109

T-TYPE IP65 insulating 136 - 137

panel supports:

page:

COB 143 - 144

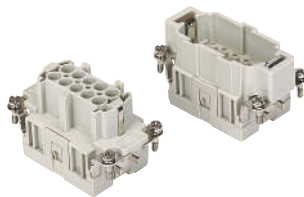
inserts, crimp connections

**16A crimp contacts
tin and gold plated**

description	part No.	part No.	part No.
-------------	----------	----------	----------

without contacts (to be ordered separately)

female inserts for female contacts

male inserts for male contacts

CCEF 10
CCEM 10
16A female contacts

0,14-0,37 mm ²	AWG 26-22	three grooves
0,5 mm ²	AWG 20	with no grooves
0,75 mm ²	AWG 18	one groove (back side)
1 mm ²	AWG 18	one groove
1,5 mm ²	AWG 16	two grooves
2,5 mm ²	AWG 14	three grooves
3 mm ²	AWG 12	one wide groove
4 mm ²	AWG 12	with no grooves

16A male contacts

0,14-0,37 mm ²	AWG 26-22	three grooves
0,5 mm ²	AWG 20	with no grooves
0,75 mm ²	AWG 18	one groove (back side)
1 mm ²	AWG 18	one groove
1,5 mm ²	AWG 16	two grooves
2,5 mm ²	AWG 14	three grooves
3 mm ²	AWG 12	one wide groove
4 mm ²	AWG 12	with no grooves

CCFS 0.3
CCFS 0.5
CCFS 0.7
CCFS 1.0
CCFS 1.5
CCFS 2.5
CCFS 3.0
CCFS 4.0

tin plated

CCFJD 0.3
CCFJD 0.5
CCFJD 0.7
CCFJD 1.0
CCFJD 1.5
CCFJD 2.5
CCFJD 3.0
CCFJD 4.0

gold plated

CCMS 0.3
CCMS 0.5
CCMS 0.7
CCMS 1.0
CCMS 1.5
CCMS 2.5
CCMS 3.0
CCMS 4.0

CCMJD 0.3
CCMJD 0.5
CCMJD 0.7
CCMJD 1.0
CCMJD 1.5
CCMJD 2.5
CCMJD 3.0
CCMJD 4.0

- characteristics according to EN 61984:

16A 500V 6kV 3
16A 400/690V 6kV 2

 - insulation resistance: $\geq 10 \text{ G}\Omega$

 - ambient temperature limit: $-40 \text{ }^\circ\text{C} \dots +125 \text{ }^\circ\text{C}$

- are made of self-extinguishing thermoplastic resin UL 94 V0

 - mechanical life: ≥ 200 cycles (tin plated)

 - mechanical life: ≥ 500 cycles (gold plated)

 - contact resistance: $\leq 1 \text{ m}\Omega$

- for contact crimping instructions, please see the crimping tool section (16A contacts, CCF, CCM series) on page 150

- for maximum current load, see the following load curves inserts, for more information see page 154

dimensions in mm

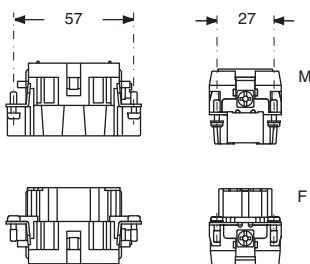

dimensions in mm

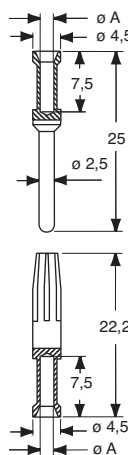
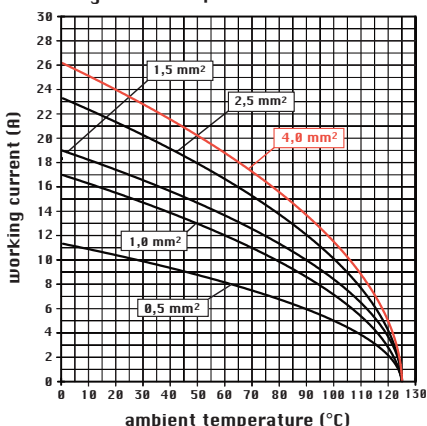
diagram CCE 10 poles

contacts side (front view)

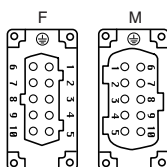

coding pin with loss of a contact CR CPQ

CCF, CCM contacts

conductor section mm ²	conductor slot ø A (mm)	conductors stripping length (mm)
0,14-0,37	0,9	7,5
0,5	1,1	7,5
0,75	1,3	7,5
1,0	1,45	7,5
1,5	1,8	7,5
2,5	2,2	7,5
3	2,55	7,5
4	2,85	7,5

WARNING:

Do not use tin plated crimp contacts coupled with gold plated crimp contacts.

dimensions shown are not binding and may be changed without notice

enclosures:

size "77.27" page:

JEI®-P thermoplastic lever 96 - 97

JEI®-V zinc-plated steel lever 110 - 114

T-TYPE IP65 insulating 138 - 139

panel supports: page:

COB 143 - 144

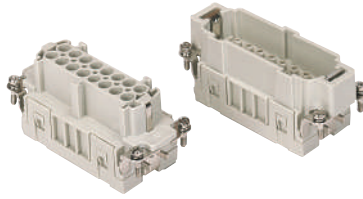
inserts, crimp connections

**16A crimp contacts
tin and gold plated**

description	part No.	part No.	part No.
-------------	----------	----------	----------

 without contacts (to be ordered separately)
 female inserts for female contacts
 male inserts for male contacts

CCEF 16
CCEM 16

16A female contacts		
0,14-0,37 mm ²	AWG 26-22	three grooves
0,5 mm ²	AWG 20	with no grooves
0,75 mm ²	AWG 18	one groove (back side)
1 mm ²	AWG 18	one groove
1,5 mm ²	AWG 16	two grooves
2,5 mm ²	AWG 14	three grooves
3 mm ²	AWG 12	one wide groove
4 mm ²	AWG 12	with no grooves

16A male contacts		
0,14-0,37 mm ²	AWG 26-22	three grooves
0,5 mm ²	AWG 20	with no grooves
0,75 mm ²	AWG 18	one groove (back side)
1 mm ²	AWG 18	one groove
1,5 mm ²	AWG 16	two grooves
2,5 mm ²	AWG 14	three grooves
3 mm ²	AWG 12	one wide groove
4 mm ²	AWG 12	with no grooves

tin plated
 CCFS 0.3
 CCFS 0.5
 CCFS 0.7
 CCFS 1.0
 CCFS 1.5
 CCFS 2.5
 CCFS 3.0
 CCFS 4.0

gold plated
 CCFJD 0.3
 CCFJD 0.5
 CCFJD 0.7
 CCFJD 1.0
 CCFJD 1.5
 CCFJD 2.5
 CCFJD 3.0
 CCFJD 4.0

 CCMS 0.3
 CCMS 0.5
 CCMS 0.7
 CCMS 1.0
 CCMS 1.5
 CCMS 2.5
 CCMS 3.0
 CCMS 4.0

 CCMJD 0.3
 CCMJD 0.5
 CCMJD 0.7
 CCMJD 1.0
 CCMJD 1.5
 CCMJD 2.5
 CCMJD 3.0
 CCMJD 4.0

- characteristics according to EN 61984:

16A 500V 6kV 3
16A 400/690V 6kV 2

- insulation resistance: $\geq 10 \text{ G}\Omega$
- ambient temperature limit: $-40 \text{ }^\circ\text{C} \dots +125 \text{ }^\circ\text{C}$
- are made of self-extinguishing thermoplastic resin UL 94 V0
- mechanical life: ≥ 200 cycles (tin plated)
- mechanical life: ≥ 500 cycles (gold plated)
- contact resistance: $\leq 1 \text{ m}\Omega$
- for contact crimping instructions, please see the crimping tool section (16A contacts, CCF, CCM series) on page 150
- for maximum current load, see the following load curves inserts, for more information see page 154

dimensions in mm

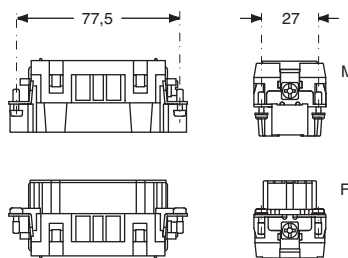

dimensions in mm

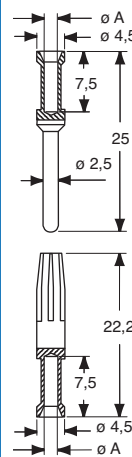
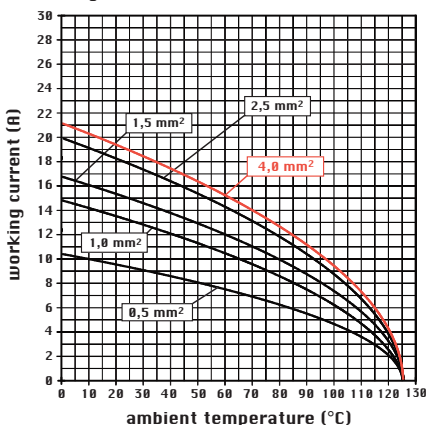
diagram CCE 16 poles

contacts side (front view)

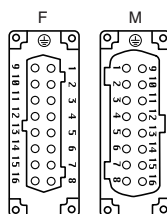

coding pin with loss of a contact CR CPQ

CCF, CCM contacts

conductor section mm ²	conductor slot ø A (mm)	conductors stripping length (mm)
0,14-0,37	0,9	7,5
0,5	1,1	7,5
0,75	1,3	7,5
1,0	1,45	7,5
1,5	1,8	7,5
2,5	2,2	7,5
3	2,55	7,5
4	2,85	7,5

WARNING:

Do not use tin plated crimp contacts coupled with gold plated crimp contacts.

 dimensions shown are not binding
 and may be changed without notice

enclosures:

size "104.27" page:

JEI®-P thermoplastic lever 98 - 99

JEI®-V zinc-plated steel lever 115 - 119

T-TYPE IP65 insulating 140 - 141

panel supports: page:

COB 143 - 144

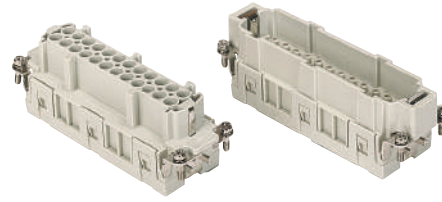
inserts, crimp connections

**16A crimp contacts
tin and gold plated**

description

part No.

part No.

part No.

without contacts (to be ordered separately)

female inserts for female contacts

male inserts for male contacts

CCEF 24
CCEM 24
16A female contacts

0,14-0,37 mm ²	AWG 26-22	three grooves
0,5 mm ²	AWG 20	with no grooves
0,75 mm ²	AWG 18	one groove (back side)
1 mm ²	AWG 18	one groove
1,5 mm ²	AWG 16	two grooves
2,5 mm ²	AWG 14	three grooves
3 mm ²	AWG 12	one wide groove
4 mm ²	AWG 12	with no grooves

16A male contacts

0,14-0,37 mm ²	AWG 26-22	three grooves
0,5 mm ²	AWG 20	with no grooves
0,75 mm ²	AWG 18	one groove (back side)
1 mm ²	AWG 18	one groove
1,5 mm ²	AWG 16	two grooves
2,5 mm ²	AWG 14	three grooves
3 mm ²	AWG 12	one wide groove
4 mm ²	AWG 12	with no grooves

tin plated
 CCFS 0.3
 CCFS 0.5
 CCFS 0.7
 CCFS 1.0
 CCFS 1.5
 CCFS 2.5
 CCFS 3.0
 CCFS 4.0

gold plated
 CCFJD 0.3
 CCFJD 0.5
 CCFJD 0.7
 CCFJD 1.0
 CCFJD 1.5
 CCFJD 2.5
 CCFJD 3.0
 CCFJD 4.0

 CCMS 0.3
 CCMS 0.5
 CCMS 0.7
 CCMS 1.0
 CCMS 1.5
 CCMS 2.5
 CCMS 3.0
 CCMS 4.0

 CCMJD 0.3
 CCMJD 0.5
 CCMJD 0.7
 CCMJD 1.0
 CCMJD 1.5
 CCMJD 2.5
 CCMJD 3.0
 CCMJD 4.0

- characteristics according to EN 61984:

16A 500V 6kV 3
16A 400/690V 6kV 2

- insulation resistance: $\geq 10 \text{ G}\Omega$
- ambient temperature limit: $-40 \text{ }^\circ\text{C} \dots +125 \text{ }^\circ\text{C}$
- are made of self-extinguishing thermoplastic resin UL 94 V0
- mechanical life: ≥ 200 cycles (tin plated)
- mechanical life: ≥ 500 cycles (gold plated)
- contact resistance: $\leq 1 \text{ m}\Omega$
- for contact crimping instructions, please see the crimping tool section (16A contacts, CCF, CCM series) on page 150
- for maximum current load, see the following load curves inserts, for more information see page 154

dimensions in mm

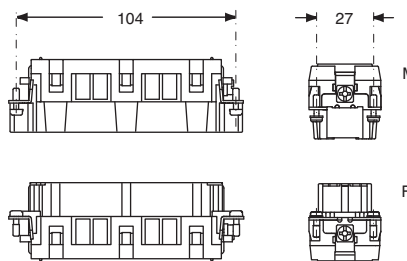

dimensions in mm

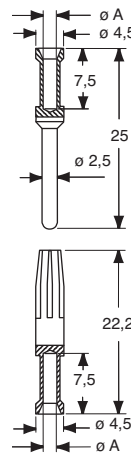
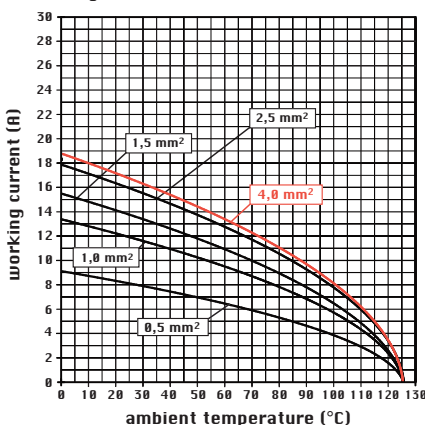
diagram CCE 24 poles

contacts side (front view)

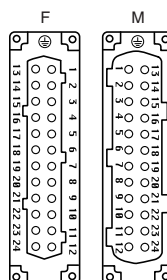

coding pin with loss of a contact CR CPQ

CCF, CCM contacts

conductor section mm ²	conductor slot $\varnothing A$ (mm)	conductors stripping length (mm)
0,14-0,37	0,9	7,5
0,5	1,1	7,5
0,75	1,3	7,5
1,0	1,45	7,5
1,5	1,8	7,5
2,5	2,2	7,5
3	2,55	7,5
4	2,85	7,5

WARNING:

Do not use tin plated crimp contacts coupled with gold plated crimp contacts.

dimensions shown are not binding and may be changed without notice

enclosures:

size "77.62"

page:

JEI®-P thermoplastic lever 100 - 101

JEI®-V zinc-plated steel lever 120 - 121

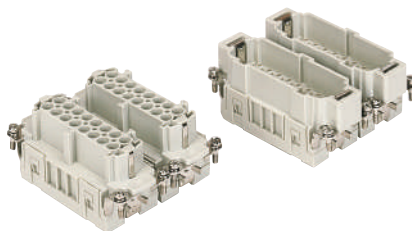
inserts, crimp connections

**16A crimp contacts
tin and gold plated**

description

part No.

part No.

part No.

part No.

 senza contatti (da ordinare separatamente)
 frutti presa per contatti femmina, num.^{no} (1÷16) e (17÷32)
 frutti spina per contatti maschio, num.^{no} (1÷16) e (17÷32)

**CCEF 16
CCEM 16**
**CCEF 16 N
CCEM 16 N**
16A female contacts

0,14-0,37 mm ²	AWG 26-22	three grooves
0,5 mm ²	AWG 20	with no grooves
0,75 mm ²	AWG 18	one groove (back side)
1 mm ²	AWG 18	one groove
1,5 mm ²	AWG 16	two grooves
2,5 mm ²	AWG 14	three grooves
3 mm ²	AWG 12	one wide groove
4 mm ²	AWG 12	with no grooves

16A male contacts

0,14-0,37 mm ²	AWG 26-22	three grooves
0,5 mm ²	AWG 20	with no grooves
0,75 mm ²	AWG 18	one groove (back side)
1 mm ²	AWG 18	one groove
1,5 mm ²	AWG 16	two grooves
2,5 mm ²	AWG 14	three grooves
3 mm ²	AWG 12	one wide groove
4 mm ²	AWG 12	with no grooves

**CCFS 0.3
CCFS 0.5
CCFS 0.7
CCFS 1.0
CCFS 1.5
CCFS 2.5
CCFS 3.0
CCFS 4.0**
tin plated
**CCFJD 0.3
CCFJD 0.5
CCFJD 0.7
CCFJD 1.0
CCFJD 1.5
CCFJD 2.5
CCFJD 3.0
CCFJD 4.0**
gold plated
**CCMS 0.3
CCMS 0.5
CCMS 0.7
CCMS 1.0
CCMS 1.5
CCMS 2.5
CCMS 3.0
CCMS 4.0**
**CCMJD 0.3
CCMJD 0.5
CCMJD 0.7
CCMJD 1.0
CCMJD 1.5
CCMJD 2.5
CCMJD 3.0
CCMJD 4.0**

- characteristics according to EN 61984:

16A 500V 6kV 3
16A 400/690V 6kV 2

- insulation resistance: $\geq 10 \text{ G}\Omega$
- ambient temperature limit: $-40 \text{ }^\circ\text{C} \dots +125 \text{ }^\circ\text{C}$
- are made of self-extinguishing thermoplastic resin UL 94 V0
- mechanical life: ≥ 200 cycles (tin plated)
- mechanical life: ≥ 500 cycles (gold plated)
- contact resistance: $\leq 1 \text{ m}\Omega$
- for contact crimping instructions, please see the crimping tool section (16A contacts, CCF, CCM series) on page 150
- for maximum current load, see the following load curves inserts, for more information see page 154

dimensions in mm

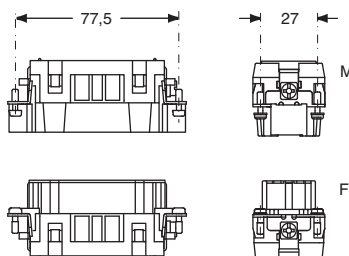

dimensions in mm

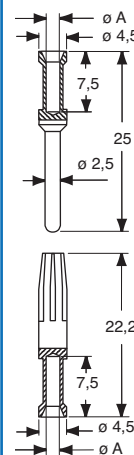

contacts side (front view)

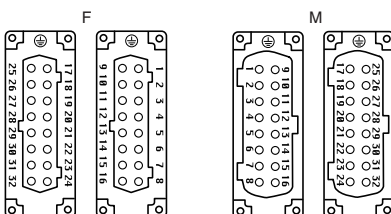

coding pin with loss of a contact CR CPQ

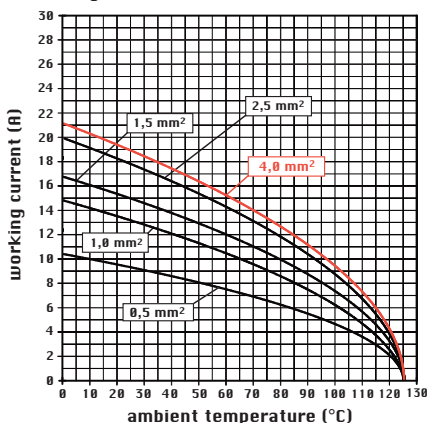
diagram CCE 32 poles

 dimensions shown are not binding
 and may be changed without notice

CCF, CCM contacts

conductor section mm ²	conductor slot ø A (mm)	conductors stripping length (mm)
0,14-0,37	0,9	7,5
0,5	1,1	7,5
0,75	1,3	7,5
1,0	1,45	7,5
1,5	1,8	7,5
2,5	2,2	7,5
3	2,55	7,5
4	2,85	7,5

WARNING:

Do not use tin plated crimp contacts coupled with gold plated crimp contacts.

enclosures:

size "104.62"

page:

JEI®-V zinc-plated steel lever 122

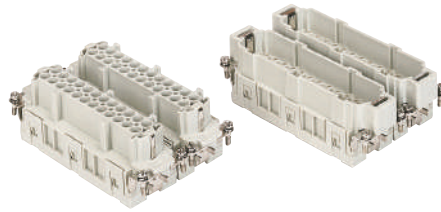
inserts, crimp connections

**16A crimp contacts
tin and gold plated**

description	part No.	part No.	part No.	part No.
senza contatti (da ordinare separatamente) frutti presa, num.ºe (1÷24) e (25÷48) frutti spina, num.ºe (1÷24) e (25÷48)	CCEF 24 CCEM 24	CCEF 24 N CCEM 24 N		
16A female contacts 0,14-0,37 mm ² AWG 26-22 three grooves 0,5 mm ² AWG 20 with no grooves 0,75 mm ² AWG 18 one groove (back side) 1 mm ² AWG 18 one groove 1,5 mm ² AWG 16 two grooves 2,5 mm ² AWG 14 three grooves 3 mm ² AWG 12 one wide groove 4 mm ² AWG 12 with no grooves			tin plated	gold plated
16A male contacts 0,14-0,37 mm ² AWG 26-22 three grooves 0,5 mm ² AWG 20 with no grooves 0,75 mm ² AWG 18 one groove (back side) 1 mm ² AWG 18 one groove 1,5 mm ² AWG 16 two grooves 2,5 mm ² AWG 14 three grooves 3 mm ² AWG 12 one wide groove 4 mm ² AWG 12 with no grooves			tin plated	gold plated
			CCFS 0.3 CCFS 0.5 CCFS 0.7 CCFS 1.0 CCFS 1.5 CCFS 2.5 CCFS 3.0 CCFS 4.0	CCFJD 0.3 CCFJD 0.5 CCFJD 0.7 CCFJD 1.0 CCFJD 1.5 CCFJD 2.5 CCFJD 3.0 CCFJD 4.0
			CCMS 0.3 CCMS 0.5 CCMS 0.7 CCMS 1.0 CCMS 1.5 CCMS 2.5 CCMS 3.0 CCMS 4.0	CCMJD 0.3 CCMJD 0.5 CCMJD 0.7 CCMJD 1.0 CCMJD 1.5 CCMJD 2.5 CCMJD 3.0 CCMJD 4.0

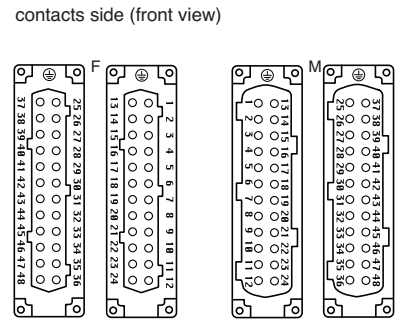
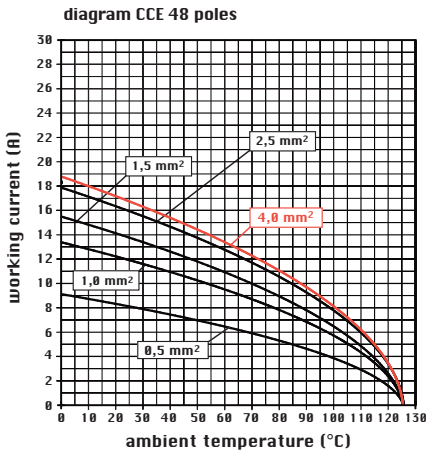
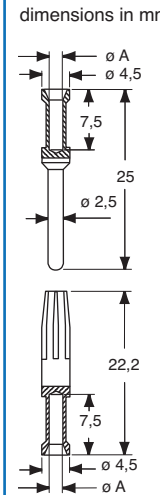
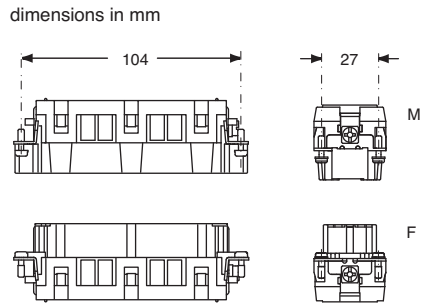
- characteristics according to EN 61984:
- 16A 500V 6kV 3**
- 16A 400/690V 6kV 2**
- insulation resistance: $\geq 10 \text{ G}\Omega$
- ambient temperature limit: $-40 \text{ }^\circ\text{C} \dots +125 \text{ }^\circ\text{C}$
- are made of self-extinguishing thermoplastic resin UL 94 V0
- mechanical life: ≥ 200 cycles (tin plated)
- mechanical life: ≥ 500 cycles (gold plated)
- contact resistance: $\leq 1 \text{ m}\Omega$
- for contact crimping instructions, please see the crimping tool section (16A contacts, CCF, CCM series) on page 150
- for maximum current load, see the following load curves inserts, for more information see page 154



coding pin with loss of a contact CR CPQ



CCF, CCM contacts

conductor section mm ²	conductor slot ø A (mm)	conductors stripping length (mm)
0,14-0,37	0,9	7,5
0,5	1,1	7,5
0,75	1,3	7,5
1,0	1,45	7,5
1,5	1,8	7,5
2,5	2,2	7,5
3	2,55	7,5
4	2,85	7,5

WARNING:
Do not use tin plated crimp contacts coupled with gold plated crimp contacts.

dimensions shown are not binding and may be changed without notice

When all the contacts are used, the CQE inserts series connectors may be used with voltages of up to 500V (first column) pollution degree 3, in accordance with the standard EN 61984.

If the number of contacts is reduced and the contacts accordingly assigned, these connectors may be used with higher voltages. This is possible because the decrease in the number of contacts leads to an increase in the surface insulation distance in the air. When the contacts are arranged as shown below, the inserts may be used for voltages of 690V (second column) and 1000V (third column) pollution degree 3, in accordance with the standard EN 61984.

Legend:

- working contact
- without contact
- M = male insert
- F = female insert

for use up to 500V
pollution degree 3

diagrams
contacts side (front view)

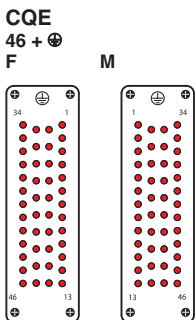
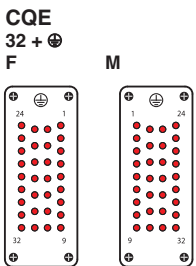
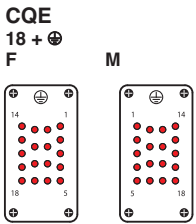
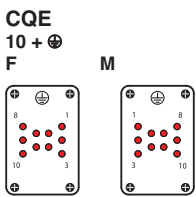

for use up to 690V
pollution degree 3

diagrams
contacts side (front view)

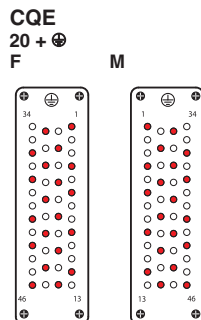
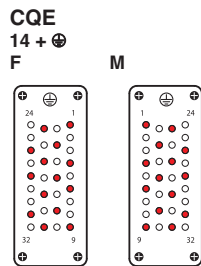
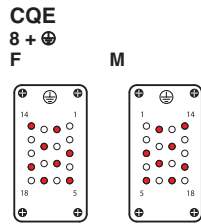
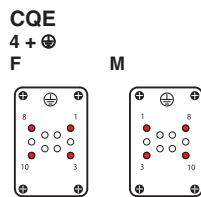

for use up to 1000V
pollution degree 3

diagrams
contacts side (front view)

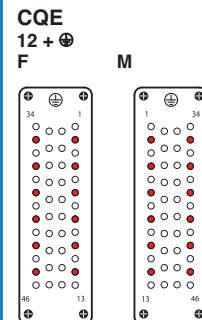
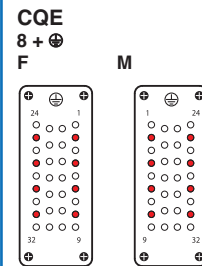
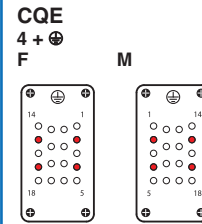
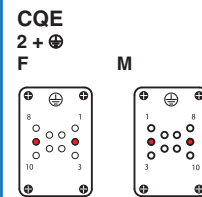

enclosures:

size "44.27"

page:

JEI®-P thermoplastic lever 92 - 93

JEI®-V zinc-plated steel lever 102 - 104

T-TYPE IP65 insulating 134 - 135

panel supports:

page:

COB 143 - 144

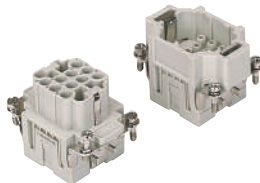
inserts, crimp connections

**16A crimp contacts
tin and gold plated**

description

part No.

part No.

part No.

without contacts (to be ordered separately)

female inserts for female contacts

male inserts for male contacts

**CQEF 10
CQEM 10**
16A female contacts

0,14-0,37 mm ²	AWG 26-22	three grooves
0,5 mm ²	AWG 20	with no grooves
0,75 mm ²	AWG 18	one groove (back side)
1 mm ²	AWG 18	one groove
1,5 mm ²	AWG 16	two grooves
2,5 mm ²	AWG 14	three grooves
3 mm ²	AWG 12	one wide groove
4 mm ²	AWG 12	with no grooves

16A male contacts

0,14-0,37 mm ²	AWG 26-22	three grooves
0,5 mm ²	AWG 20	with no grooves
0,75 mm ²	AWG 18	one groove (back side)
1 mm ²	AWG 18	one groove
1,5 mm ²	AWG 16	two grooves
2,5 mm ²	AWG 14	three grooves
3 mm ²	AWG 12	one wide groove
4 mm ²	AWG 12	with no grooves

tin plated
 CCFS 0.3
 CCFS 0.5
 CCFS 0.7
 CCFS 1.0
 CCFS 1.5
 CCFS 2.5
 CCFS 3.0
 CCFS 4.0

gold plated
 CCFJD 0.3
 CCFJD 0.5
 CCFJD 0.7
 CCFJD 1.0
 CCFJD 1.5
 CCFJD 2.5
 CCFJD 3.0
 CCFJD 4.0

tin plated
 CCMS 0.3
 CCMS 0.5
 CCMS 0.7
 CCMS 1.0
 CCMS 1.5
 CCMS 2.5
 CCMS 3.0
 CCMS 4.0

gold plated
 CCMJD 0.3
 CCMJD 0.5
 CCMJD 0.7
 CCMJD 1.0
 CCMJD 1.5
 CCMJD 2.5
 CCMJD 3.0
 CCMJD 4.0

- characteristics according to EN 61984:

16A 500V 6kV 3
16A 830V 8kV 2

- rated voltage according to UL/CSA: 600V
- insulation resistance: $\geq 10 \text{ G}\Omega$
- ambient temperature limit: $-40 \text{ }^\circ\text{C} \dots +125 \text{ }^\circ\text{C}$
- are made of self-extinguishing thermoplastic resin UL 94 V0
- mechanical life: ≥ 200 cycles (tin plated)
- mechanical life: ≥ 500 cycles (gold plated)
- contact resistance: $\leq 1 \text{ m}\Omega$
- for contact crimping instructions, please see the crimping tool section (16A contacts, CCF, CCM series) on page 150
- for maximum current load, see the following load curves inserts, for more information see page 154

dimensions in mm

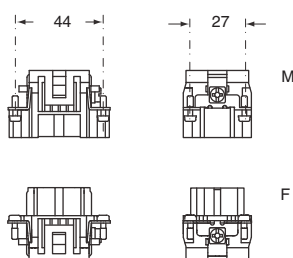

dimensions in mm

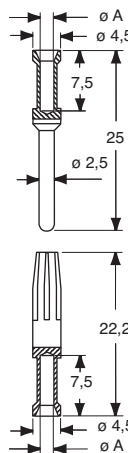
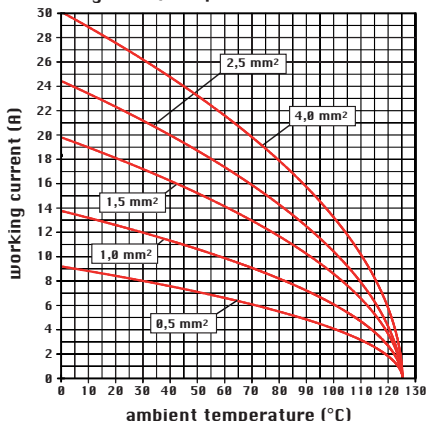
diagram CQE 10 poles

contacts side (front view)

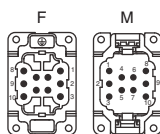

coding pin with loss of a contact CR CPQ

 dimensions shown are not binding
and may be changed without notice

CCF, CCM contacts

conductor section mm ²	conductor slot ø A (mm)	conductors stripping length (mm)
0,14-0,37	0,9	7,5
0,5	1,1	7,5
0,75	1,3	7,5
1,0	1,45	7,5
1,5	1,8	7,5
2,5	2,2	7,5
3	2,55	7,5
4	2,85	7,5

WARNING:

Do not use tin plated crimp contacts coupled with gold plated crimp contacts.

enclosures:

size "57.27"

page:

JEI®-P thermoplastic lever 94 - 95

JEI®-V zinc-plated steel lever 105 - 109

T-TYPE IP65 insulating 136 - 137

panel supports:

page:

COB 143 - 144

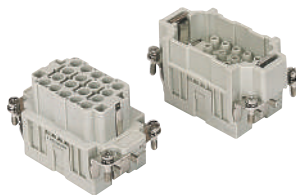
inserts, crimp connections

**16A crimp contacts
tin and gold plated**

description

part No.

part No.

part No.

without contacts (to be ordered separately)

female inserts for female contacts

male inserts for male contacts

**CQEF 18
CQEM 18**
16A female contacts

0,14-0,37 mm ²	AWG 26-22	three grooves
0,5 mm ²	AWG 20	with no grooves
0,75 mm ²	AWG 18	one groove (back side)
1 mm ²	AWG 18	one groove
1,5 mm ²	AWG 16	two grooves
2,5 mm ²	AWG 14	three grooves
3 mm ²	AWG 12	one wide groove
4 mm ²	AWG 12	with no grooves

16A male contacts

0,14-0,37 mm ²	AWG 26-22	three grooves
0,5 mm ²	AWG 20	with no grooves
0,75 mm ²	AWG 18	one groove (back side)
1 mm ²	AWG 18	one groove
1,5 mm ²	AWG 16	two grooves
2,5 mm ²	AWG 14	three grooves
3 mm ²	AWG 12	one wide groove
4 mm ²	AWG 12	with no grooves

CCFS 0.3
CCFS 0.5
CCFS 0.7
CCFS 1.0
CCFS 1.5
CCFS 2.5
CCFS 3.0
CCFS 4.0

tin plated

CCFJD 0.3
CCFJD 0.5
CCFJD 0.7
CCFJD 1.0
CCFJD 1.5
CCFJD 2.5
CCFJD 3.0
CCFJD 4.0

gold plated

CCMS 0.3
CCMS 0.5
CCMS 0.7
CCMS 1.0
CCMS 1.5
CCMS 2.5
CCMS 3.0
CCMS 4.0

CCMJD 0.3
CCMJD 0.5
CCMJD 0.7
CCMJD 1.0
CCMJD 1.5
CCMJD 2.5
CCMJD 3.0
CCMJD 4.0

- characteristics according to EN 61984:

**16A 500V 6kV 3
16A 830V 8kV 2**

- rated voltage according to UL/CSA: 600V
- insulation resistance: $\geq 10 \text{ G}\Omega$
- ambient temperature limit: $-40 \text{ }^\circ\text{C} \dots +125 \text{ }^\circ\text{C}$
- are made of self-extinguishing thermoplastic resin UL 94 V0
- mechanical life: ≥ 200 cycles (tin plated)
- mechanical life: ≥ 500 cycles (gold plated)
- contact resistance: $\leq 1 \text{ m}\Omega$
- for contact crimping instructions, please see the crimping tool section (16A contacts, CCF, CCM series) on page 150
- for maximum current load, see the following load curves inserts, for more information see page 154

dimensions in mm

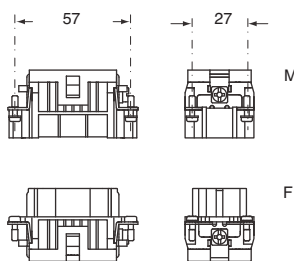

dimensions in mm

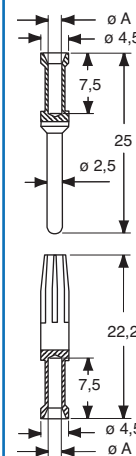
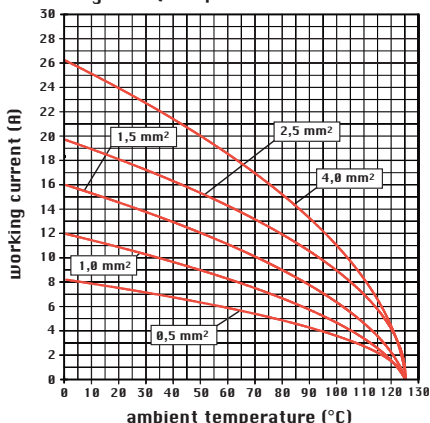
diagram CQE 18 poles

contacts side (front view)

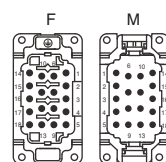

coding pin with loss of a contact CR CPQ

CCF, CCM contacts

conductor section mm ²	conductor slot ø A (mm)	conductors stripping length (mm)
0,14-0,37	0,9	7,5
0,5	1,1	7,5
0,75	1,3	7,5
1,0	1,45	7,5
1,5	1,8	7,5
2,5	2,2	7,5
3	2,55	7,5
4	2,85	7,5

WARNING:

Do not use tin plated crimp contacts coupled with gold plated crimp contacts.

 dimensions shown are not binding
and may be changed without notice

enclosures:

size "77.27" page:

JEI®-P thermoplastic lever 96 - 97

JEI®-V zinc-plated steel lever 110 - 114

T-TYPE IP65 insulating 138 - 139

panel supports: page:

COB 143 - 144

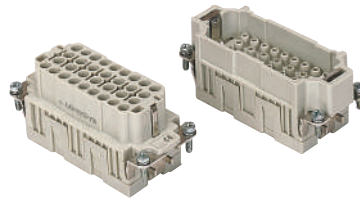
inserts, crimp connections

**16A crimp contacts
tin and gold plated**

description	part No.	part No.	part No.
-------------	----------	----------	----------

without contacts (to be ordered separately)

female inserts for female contacts

male inserts for male contacts

CQEF 32
CQEM 32
16A female contacts

0,14-0,37 mm ²	AWG 26-22	three grooves
0,5 mm ²	AWG 20	with no grooves
0,75 mm ²	AWG 18	one groove (back side)
1 mm ²	AWG 18	one groove
1,5 mm ²	AWG 16	two grooves
2,5 mm ²	AWG 14	three grooves
3 mm ²	AWG 12	one wide groove
4 mm ²	AWG 12	with no grooves

16A male contacts

0,14-0,37 mm ²	AWG 26-22	three grooves
0,5 mm ²	AWG 20	with no grooves
0,75 mm ²	AWG 18	one groove (back side)
1 mm ²	AWG 18	one groove
1,5 mm ²	AWG 16	two grooves
2,5 mm ²	AWG 14	three grooves
3 mm ²	AWG 12	one wide groove
4 mm ²	AWG 12	with no grooves

tin plated
 CCFS 0.3
 CCFS 0.5
 CCFS 0.7
 CCFS 1.0
 CCFS 1.5
 CCFS 2.5
 CCFS 3.0
 CCFS 4.0

gold plated
 CCFJD 0.3
 CCFJD 0.5
 CCFJD 0.7
 CCFJD 1.0
 CCFJD 1.5
 CCFJD 2.5
 CCFJD 3.0
 CCFJD 4.0

tin plated
 CCMS 0.3
 CCMS 0.5
 CCMS 0.7
 CCMS 1.0
 CCMS 1.5
 CCMS 2.5
 CCMS 3.0
 CCMS 4.0

gold plated
 CCMJD 0.3
 CCMJD 0.5
 CCMJD 0.7
 CCMJD 1.0
 CCMJD 1.5
 CCMJD 2.5
 CCMJD 3.0
 CCMJD 4.0

- characteristics according to EN 61984:

16A 500V 6kV 3
16A 830V 8kV 2

- rated voltage according to UL/CSA: 600V

- insulation resistance: ≥ 10 GΩ

- ambient temperature limit: -40 °C ... +125 °C

- are made of self-extinguishing thermoplastic resin UL 94 V0

- mechanical life: ≥ 200 cycles (tin plated)

- mechanical life: ≥ 500 cycles (gold plated)

- contact resistance: ≤ 1 mΩ

- for contact crimping instructions, please see the crimping tool section (16A contacts, CCF, CCM series) on page 150

- for maximum current load, see the following load curves inserts, for more information see page 154

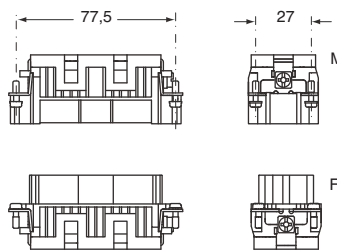
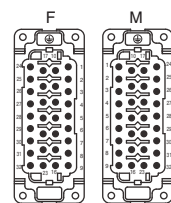
dimensions in mm

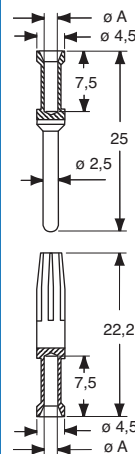
contacts side (front view)

coding pin with loss of a contact CR CPQ

dimensions in mm

CCF, CCM contacts

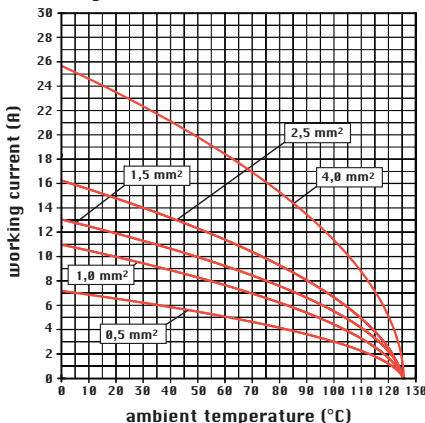
conductor section mm ²	conductor slot ø A (mm)	conductors stripping length (mm)
0,14-0,37	0,9	7,5
0,5	1,1	7,5
0,75	1,3	7,5
1,0	1,45	7,5
1,5	1,8	7,5
2,5	2,2	7,5
3	2,55	7,5
4	2,85	7,5

WARNING:

Do not use tin plated crimp contacts coupled with gold plated crimp contacts.

diagram CQE 32 poles

dimensions shown are not binding and may be changed without notice

enclosures:

size "104.27" page:

JEI®-P thermoplastic lever 98 - 99

JEI®-V zinc-plated steel lever 115 - 119

T-TYPE IP65 insulating 140 - 141

panel supports: page:

COB 143 - 144

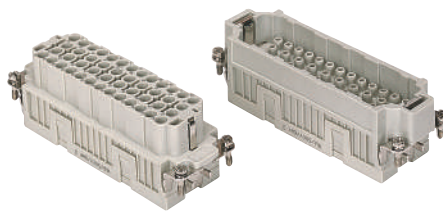
inserts, crimp connections

**16A crimp contacts
tin and gold plated**

description	part No.	part No.	part No.
-------------	----------	----------	----------

 without contacts (to be ordered separately)
 female inserts for female contacts
 male inserts for male contacts

CQEF 46
CQEM 46

16A female contacts		
0,14-0,37 mm ²	AWG 26-22	three grooves
0,5 mm ²	AWG 20	with no grooves
0,75 mm ²	AWG 18	one groove (back side)
1 mm ²	AWG 18	one groove
1,5 mm ²	AWG 16	two grooves
2,5 mm ²	AWG 14	three grooves
3 mm ²	AWG 12	one wide groove
4 mm ²	AWG 12	with no grooves

16A male contacts		
0,14-0,37 mm ²	AWG 26-22	three grooves
0,5 mm ²	AWG 20	with no grooves
0,75 mm ²	AWG 18	one groove (back side)
1 mm ²	AWG 18	one groove
1,5 mm ²	AWG 16	two grooves
2,5 mm ²	AWG 14	three grooves
3 mm ²	AWG 12	one wide groove
4 mm ²	AWG 12	with no grooves

tin plated
 CCFS 0.3
 CCFS 0.5
 CCFS 0.7
 CCFS 1.0
 CCFS 1.5
 CCFS 2.5
 CCFS 3.0
 CCFS 4.0

gold plated
 CCFJD 0.3
 CCFJD 0.5
 CCFJD 0.7
 CCFJD 1.0
 CCFJD 1.5
 CCFJD 2.5
 CCFJD 3.0
 CCFJD 4.0

tin plated
 CCMS 0.3
 CCMS 0.5
 CCMS 0.7
 CCMS 1.0
 CCMS 1.5
 CCMS 2.5
 CCMS 3.0
 CCMS 4.0

gold plated
 CCMJD 0.3
 CCMJD 0.5
 CCMJD 0.7
 CCMJD 1.0
 CCMJD 1.5
 CCMJD 2.5
 CCMJD 3.0
 CCMJD 4.0

- characteristics according to EN 61984:

16A 500V 6kV 3
16A 830V 8kV 2

- rated voltage according to UL/CSA: 600V
- insulation resistance: $\geq 10 \text{ G}\Omega$
- ambient temperature limit: $-40 \text{ }^\circ\text{C} \dots +125 \text{ }^\circ\text{C}$
- are made of self-extinguishing thermoplastic resin UL 94 V0
- mechanical life: ≥ 200 cycles (tin plated)
- mechanical life: ≥ 500 cycles (gold plated)
- contact resistance: $\leq 1 \text{ m}\Omega$
- for contact crimping instructions, please see the crimping tool section (16A contacts, CCF, CCM series) on page 150
- for maximum current load, see the following load curves inserts, for more information see page 154

dimensions in mm

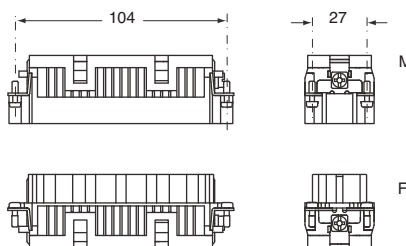

dimensions in mm

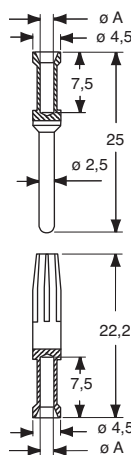
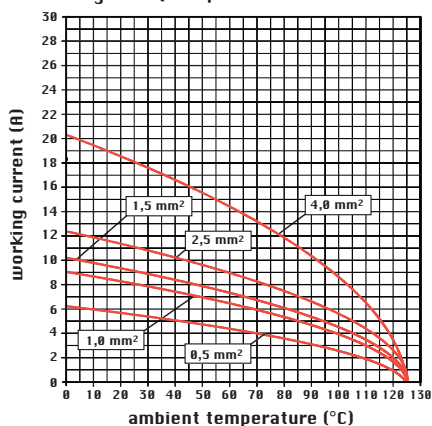
diagram CQE 46 poles

contacts side (front view)

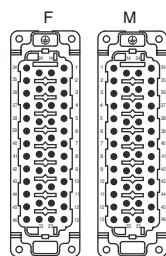

coding pin with loss of a contact CR CPQ

CCF, CCM contacts

conductor section mm ²	conductor slot ø A (mm)	conductors stripping length (mm)
0,14-0,37	0,9	7,5
0,5	1,1	7,5
0,75	1,3	7,5
1,0	1,45	7,5
1,5	1,8	7,5
2,5	2,2	7,5
3	2,55	7,5
4	2,85	7,5

WARNING:

Do not use tin plated crimp contacts coupled with gold plated crimp contacts.

 dimensions shown are not binding
 and may be changed without notice

enclosures:

size "77.62"

page:

JEI®-P thermoplastic lever 100 - 101

JEI®-V zinc-plated steel lever 120 - 121

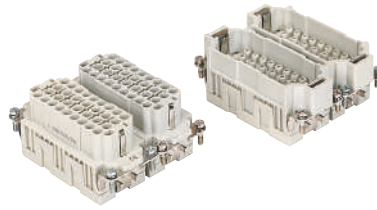
inserts, crimp connections

**16A crimp contacts
tin and gold plated**

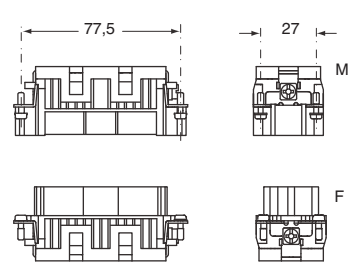

description	part No.	part No.	part No.	part No.
without contacts (to be ordered separately) frutti presa, num.ºe (1÷32) e (33÷64) frutti spina, num.ºe (1÷32) e (33÷64)	CQEF 32 CQEM 32	CQEF 32 N CQEM 32 N		
16A female contacts 0,14-0,37 mm ² AWG 26-22 three grooves 0,5 mm ² AWG 20 with no grooves 0,75 mm ² AWG 18 one groove (back side) 1 mm ² AWG 18 one groove 1,5 mm ² AWG 16 two grooves 2,5 mm ² AWG 14 three grooves 3 mm ² AWG 12 one wide groove 4 mm ² AWG 12 with no grooves			CCFS 0.3 CCFS 0.5 CCFS 0.7 CCFS 1.0 CCFS 1.5 CCFS 2.5 CCFS 3.0 CCFS 4.0	CCFJD 0.3 CCFJD 0.5 CCFJD 0.7 CCFJD 1.0 CCFJD 1.5 CCFJD 2.5 CCFJD 3.0 CCFJD 4.0
16A male contacts 0,14-0,37 mm ² AWG 26-22 three grooves 0,5 mm ² AWG 20 with no grooves 0,75 mm ² AWG 18 one groove (back side) 1 mm ² AWG 18 one groove 1,5 mm ² AWG 16 two grooves 2,5 mm ² AWG 14 three grooves 3 mm ² AWG 12 one wide groove 4 mm ² AWG 12 with no grooves			CCMS 0.3 CCMS 0.5 CCMS 0.7 CCMS 1.0 CCMS 1.5 CCMS 2.5 CCMS 3.0 CCMS 4.0	CCMJD 0.3 CCMJD 0.5 CCMJD 0.7 CCMJD 1.0 CCMJD 1.5 CCMJD 2.5 CCMJD 3.0 CCMJD 4.0

- characteristics according to EN 61984:
- 16A 500V 6kV 3**
- 16A 830V 8kV 2**
- rated voltage according to UL/CSA: 600V
- insulation resistance: ≥ 10 GΩ
- ambient temperature limit: -40 °C ... +125 °C
- are made of self-extinguishing thermoplastic resin UL 94 V0
- mechanical life: ≥ 200 cycles (tin plated)
- mechanical life: ≥ 500 cycles (gold plated)
- contact resistance: ≤ 1 mΩ
- for contact crimping instructions, please see the crimping tool section (16A contacts, CCF, CCM series) on page 150
- for maximum current load, see the following load curves inserts, for more information see page 154

dimensions in mm

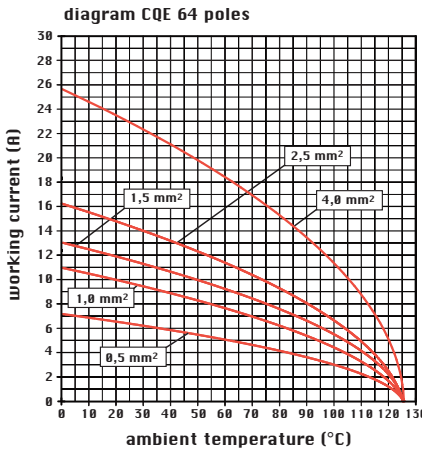
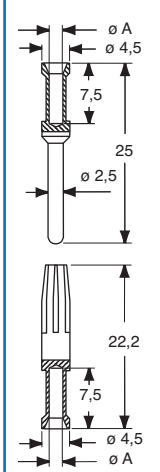

dimensions in mm



contacts side (front view)

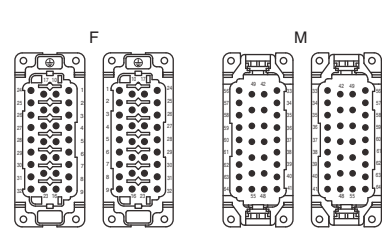

coding pin with loss of a contact CR CPQ

CCF, CCM contacts

conductor section mm ²	conductor slot ø A (mm)	conductors stripping length (mm)
0,14-0,37	0,9	7,5
0,5	1,1	7,5
0,75	1,3	7,5
1,0	1,45	7,5
1,5	1,8	7,5
2,5	2,2	7,5
3	2,55	7,5
4	2,85	7,5

WARNING:

Do not use tin plated crimp contacts coupled with gold plated crimp contacts.

dimensions shown are not binding and may be changed without notice

enclosures:

size "104.62"

page:

JEI®-V zinc-plated steel lever 122

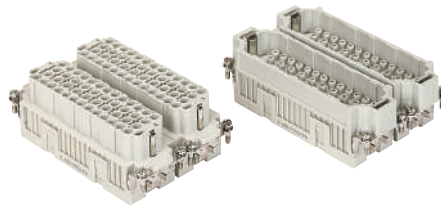
inserts, crimp connections

**16A crimp contacts
tin and gold plated**

description	part No.	part No.	part No.	part No.
senza contatti (da ordinare separatamente)				
frutti presa, num. ^{ne} (1÷46) e (47÷92)	CQEF 46	CQEF 46 N		
frutti spina, num. ^{ne} (1÷46) e (47÷92)	CQEM 46	CQEM 46 N		
16A female contacts				
0,14-0,37 mm ² AWG 26-22 three grooves			CCFS 0.3	CCFJD 0.3
0,5 mm ² AWG 20 with no grooves			CCFS 0.5	CCFJD 0.5
0,75 mm ² AWG 18 one groove (back side)			CCFS 0.7	CCFJD 0.7
1 mm ² AWG 18 one groove			CCFS 1.0	CCFJD 1.0
1,5 mm ² AWG 16 two grooves			CCFS 1.5	CCFJD 1.5
2,5 mm ² AWG 14 three grooves			CCFS 2.5	CCFJD 2.5
3 mm ² AWG 12 one wide groove			CCFS 3.0	CCFJD 3.0
4 mm ² AWG 12 with no grooves			CCFS 4.0	CCFJD 4.0
16A male contacts				
0,14-0,37 mm ² AWG 26-22 three grooves			CCMS 0.3	CCMJD 0.3
0,5 mm ² AWG 20 with no grooves			CCMS 0.5	CCMJD 0.5
0,75 mm ² AWG 18 one groove (back side)			CCMS 0.7	CCMJD 0.7
1 mm ² AWG 18 one groove			CCMS 1.0	CCMJD 1.0
1,5 mm ² AWG 16 two grooves			CCMS 1.5	CCMJD 1.5
2,5 mm ² AWG 14 three grooves			CCMS 2.5	CCMJD 2.5
3 mm ² AWG 12 one wide groove			CCMS 3.0	CCMJD 3.0
4 mm ² AWG 12 with no grooves			CCMS 4.0	CCMJD 4.0

tin plated
gold plated

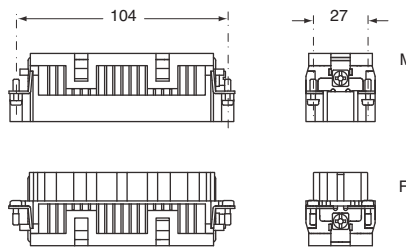
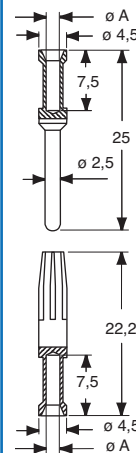
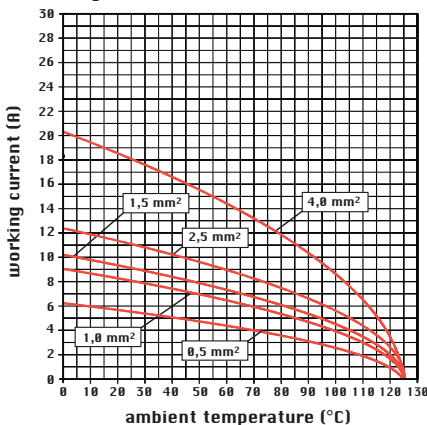
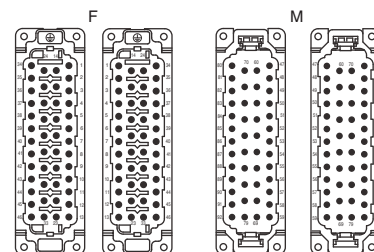
- characteristics according to EN 61984:
- 16A 500V 6kV 3**
- 16A 830V 8kV 2**
- rated voltage according to UL/CSA: 600V
- insulation resistance: ≥ 10 GΩ
- ambient temperature limit: -40 °C ... +125 °C
- are made of self-extinguishing thermoplastic resin UL 94 V0
- mechanical life: ≥ 200 cycles (tin plated)
- mechanical life: ≥ 500 cycles (gold plated)
- contact resistance: ≤ 1 mΩ
- for contact crimping instructions, please see the crimping tool section (16A contacts, CCF, CCM series) on page 150
- for maximum current load, see the following load curves inserts, for more information see page 154

dimensions in mm

dimensions in mm

diagram CQE 92 poles

contacts side (front view)

coding pin with loss of a contact CR CPQ

CCF, CCM contacts

conductor section mm ²	conductor slot ø A (mm)	conductors stripping length (mm)
0,14-0,37	0,9	7,5
0,5	1,1	7,5
0,75	1,3	7,5
1,0	1,45	7,5
1,5	1,8	7,5
2,5	2,2	7,5
3	2,55	7,5
4	2,85	7,5

WARNING:

Do not use tin plated crimp contacts coupled with gold plated crimp contacts.

Identification of enclosures

Connector inserts and their enclosures are numerous and therefore the search for the correct pairing of one with another can be complex.

To facilitate this operation (in addition to the normal part number) the definition of "size" has been introduced in this catalogue.

As indicated in the illustration on the left and in the table below the size value refers to the screw fixing centre distances which constitute a unique element since they are common to both the inserts and the enclosures.

All the pages that illustrate combinable articles (inserts and enclosures) carry references as per the examples illustrated on the opposite page.

Following is a table that shows all the sizes of the enclosures and the dimensions of the housings where the inserts will be fastened.

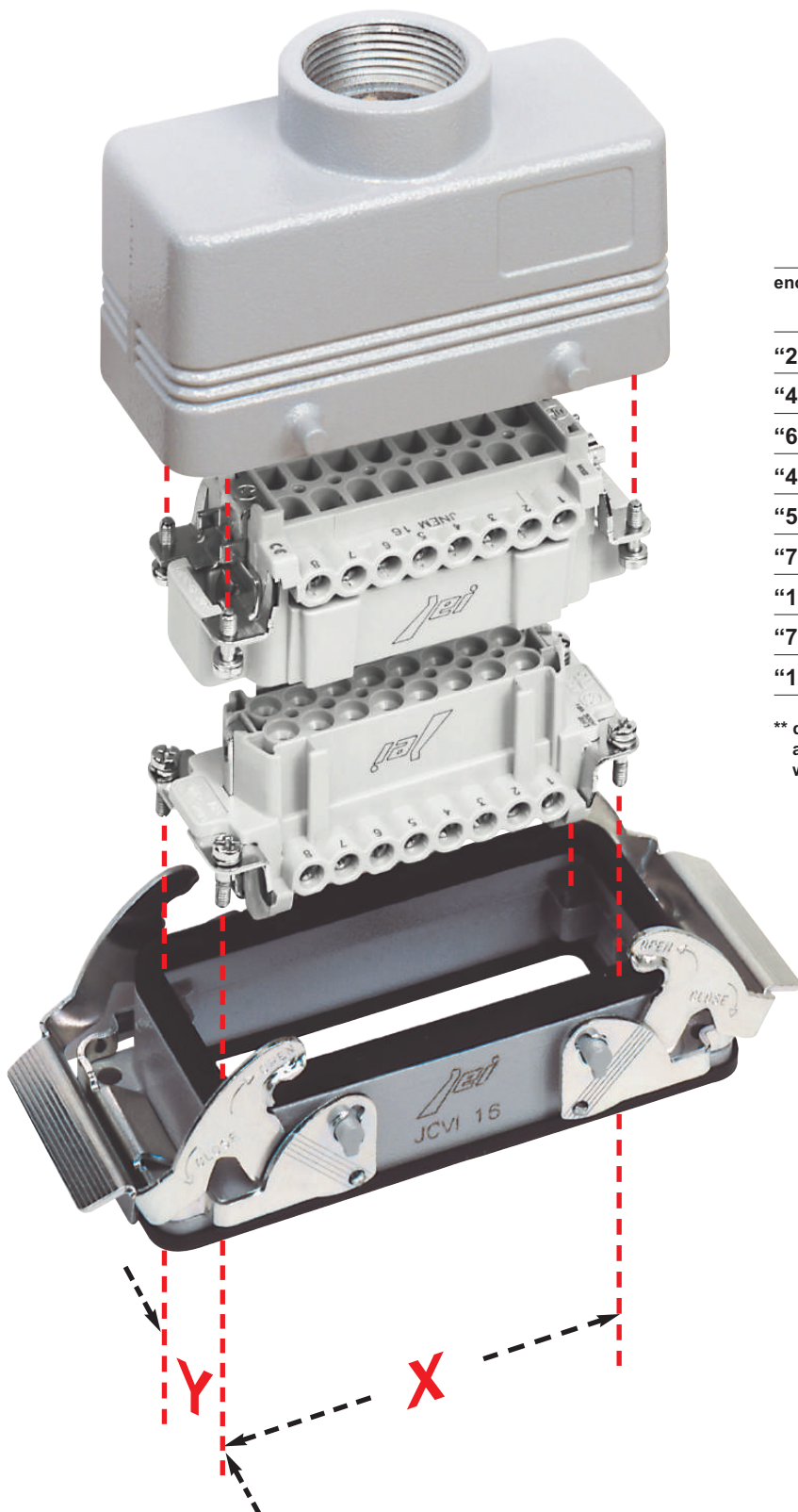

enclosures size	insert housing with screw fixing centre distance x-y
"21.21"	(21 x 21 mm) **
"49.16"	49,5 x 16 mm
"66.16"	66 x 16 mm
"44.27"	44 x 27 mm
"57.27"	57 x 27 mm
"77.27"	77,5 x 27 mm
"104.27"	104 x 27 mm
"77.62"	77,5 x 27 mm (2 inserts)
"104.62"	104 x 27 mm (2 inserts)

** dimensions relating to the insert cross-section size not being able to identify a screw fixing centre distance since provided with a single screw.

inserts:		page:
CD	15 poles + ⊕	33
JDA	10 poles + ⊕	48

bulkhead mounting housings with single lever



thermoplastic lever

surface mounting housings with single lever



thermoplastic lever

description	part No.		part No.		part No.	
				entry Pg		entry M
with single lever	JPI 15 L					
with single lever			JPP 15 L16	16	JMPP 15 L25	25
with single lever			JPP 15 L216	16 x 2	JMPP 15 L225	25 x 2
with single lever			JPP 15 L21	21		

panel cut-out for bulkhead mounting housings in mm

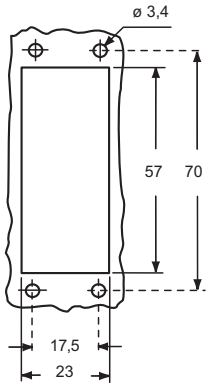

dimensions in mm

JPI L

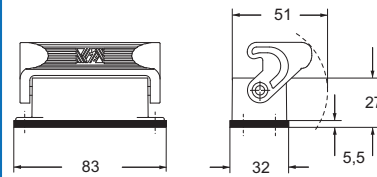

dimensions in mm

JPP L and JMPP L

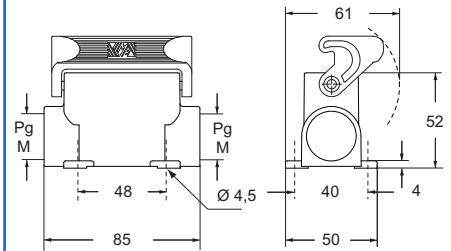

CULUS Type 4/4X/12

EAC



dimensions shown are not binding and may be changed without notice

inserts:	page:
CD 15 poles + ⊕	33
JDA 10 poles + ⊕	48

Cover versions L and LG cannot be used together with coding pins. If this application is required, please contact ILME SpA.

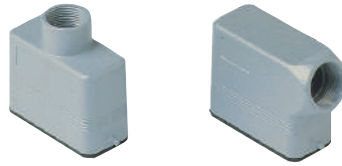
hoods with 2 pegs

hoods with single lever covers with 2 pegs and single lever

thermoplastic lever

**AVAILABLE
END 2015**

description	part No.		part No.		part No.	entry Pg	part No.	entry M
	entry Pg	entry M	entry Pg	entry M				
with pegs, side entry	CZO 15 L	16	MZO 15 L20	20				
with pegs, side entry			MZO 15 L25	25				
with pegs, top entry	CZV 15 L	13,5	MZV 15 L20	20				
with pegs, side entry, high construction, without adaptor *	CZFO 15 L16	16	MZFO 15 L20	20				
with pegs, side entry, high construction, without adaptor *	CZFO 15 L21	21	MZFO 15 L25	25				
with pegs, top entry, high construction, without adaptor *	CZFV 15 L16	16	MZFV 15 L20	20				
with pegs, top entry, high construction, without adaptor *	CZFV 15 L21	21	MZFV 15 L25	25				
with single lever, top entry					JPV 15 LG13	13,5	JMPV 15 LG20	20
with pegs (for enclosures with single lever)					CZC 15 L			
with single lever (for hoods with pegs)					JPC 15 LG			

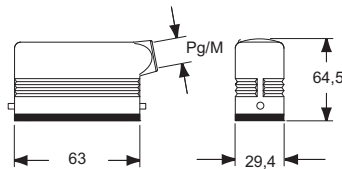
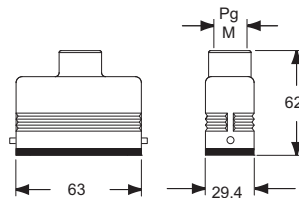
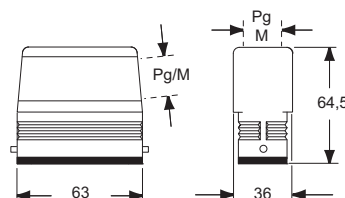
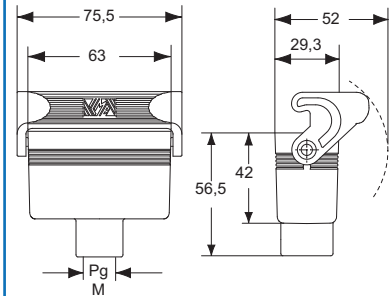
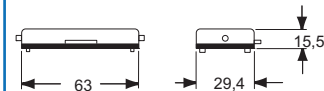
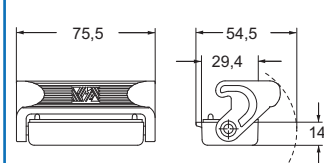
* enclosure without adaptor, threaded on the body, to enclosure to be used only with a complete cable gland.

dimensions in mm
CZO L and MZO L

CZV L and MZV L

CZFO L - MZFO L and CZFV L - MZFV L

dimensions in mm
JPV LG and JMPV LG

CZC L

JPC LG

CALUS® Type 4/4X/12
(excluding cover JPC 15 LG)

EAC



dimensions shown are not binding and may be changed without notice

inserts:	page:
CD 25 poles + ⊕	34
CDD 38 poles + ⊕	41
JDA 16 poles + ⊕	49

bulkhead mounting housings with single lever



thermoplastic lever

surface mounting housings with single lever



thermoplastic lever

description	part No.		part No.		part No.	
				entry Pg		entry M
with single lever	JPI 25 L					
with single lever			JPP 25 L16	16	JMPP 25 L25	25
with single lever			JPP 25 L216	16 x 2	JMPP 25 L225	25 x 2
with single lever			JPP 25 L21	21		

panel cut-out for bulkhead mounting housings in mm

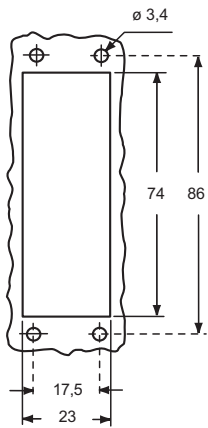

dimensions in mm

JPI L

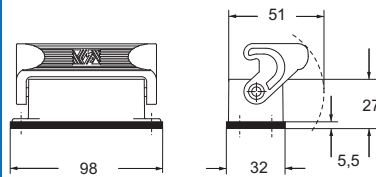

dimensions in mm

JPP L and JMPP L

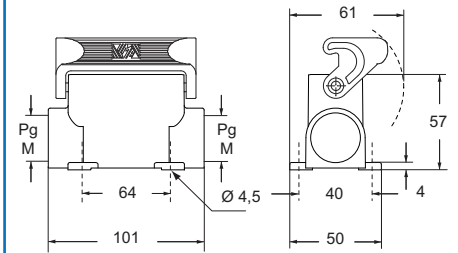

CE® **US** Type 4/4X/12

EAC



dimensions shown are not binding and may be changed without notice

inserts:	page:
CD 25 poles + ⊕	34
CDD 38 poles + ⊕	41
JDA 16 poles + ⊕	49

Cover versions L and LG cannot be used together with coding pins. If this application is required, please contact ILME SpA.

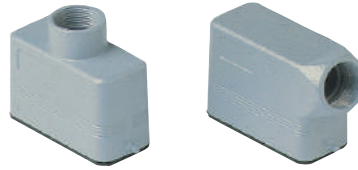
hoods with 2 pegs

hoods with single lever covers with 2 pegs and single lever



thermoplastic lever

**AVAILABLE
END 2015**

description	part No.		part No.		part No.		part No.	
		entry Pg		entry M		entry Pg		entry M
with pegs, side entry	CZO 25 L	16	MZO 25 L20	20				
with pegs, side entry			MZO 25 L25	25				
with pegs, top entry	CZV 25 L	16	MZV 25 L20 **	20				
with pegs, side entry, high construction, without adaptor *	CZFO 25 L16	16	MZFO 25 L20	20				
with pegs, side entry, high construction, without adaptor *	CZFO 25 L21	21	MZFO 25 L25	25				
with pegs, top entry, high construction, without adaptor *	CZFV 25 L16	16	MZFV 25 L20	20				
with pegs, top entry, high construction, without adaptor *	CZFV 25 L21	21	MZFV 25 L25	25				
with single lever, top entry					JPV 25 LG16	16	JMPV 25 LG20 **	20
with pegs (for enclosures with single lever)					CZC 25 L			
with single lever (for hoods with pegs)					JPC 25 LG			

* enclosure without adaptor, threaded on the body, to enclosure to be used only with a complete cable gland.

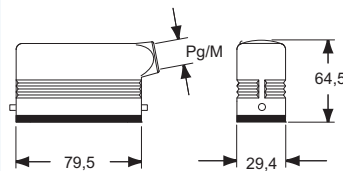
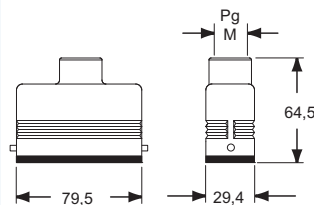
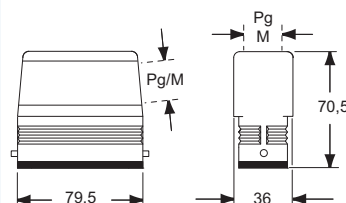
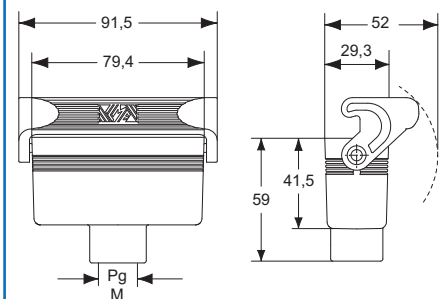
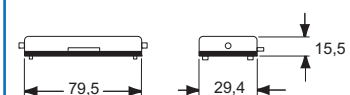
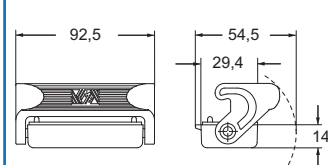
** can only be used with a complete cable gland (to be purchased separately).

dimensions in mm
CZO L and MZO L

CZV L and MZV L

CZFO L - MZFO L and CZFV L - MZFV L

dimensions in mm
JPV LG and JMPV LG

CZC L

JPC LG

CALUS® Type 4/4X/12
(excluding cover JPC 25 LG)

EAC



dimensions shown are not binding and may be changed without notice

inserts:	page:
CDD 24 poles + ⊕	40
JDS 9 poles + ⊕	54
JSH 6 poles + ⊕	62
JNE, JSE 6 poles + ⊕	68
CCE 6 poles + ⊕	74
CQE 10 poles + ⊕	81

insert centre distance:
44 x 27 mm

bulkhead mounting housings with single lever



thermoplastic lever

surface mounting housings with single lever



thermoplastic lever

description	part No.	part No.	entry Pg	part No.	entry M
with single lever	JPI 06 L				
with single lever		JPP 06 L16	16	JMPP 06 L20	20
with single lever		JPP 06 L216	16 x 2	JMPP 06 L220	20 x 2
with single lever, high construction		JPAP 06 L21	21	JMPAP 06 L32	32
with single lever, high construction		JPAP 06 L221	21 x 2	JMPAP 06L232	32 x 2

panel cut-out for bulkhead mounting housings in mm

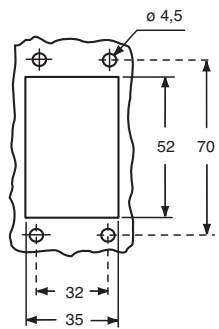

dimensions in mm

JPI L

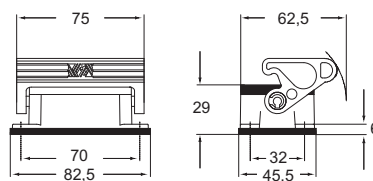

dimensions in mm

JPP L - JPAP L and JMPP L - JMPAP L

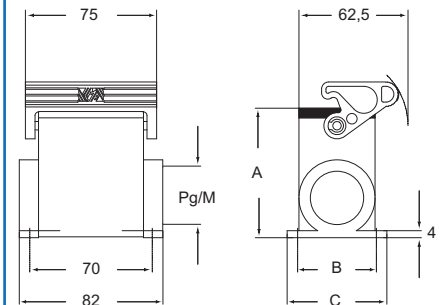

type	A	B	C
JPP L / JMPP L	53	40	52
JPAP L / JMPAP L	74	45	57

CAUS® Type 4/4X/12

EAC



dimensions shown are not binding and may be changed without notice

inserts: page:

CDD	24 poles + ⊕	40
JDS	9 poles + ⊕	54
JSH	6 poles + ⊕	62
JNE, JSE	6 poles + ⊕	68
CCE	6 poles + ⊕	74
CQE	10 poles + ⊕	81

 insert centre distance:
44 x 27 mm
hoods with 2 pegs

hoods with gasket and 1 lever covers with 2 pegs and 1 lever

thermoplastic lever

description	part No.		entry		part No.		entry	
			Pg	M			Pg	M
with pegs, side entry	CHO 06 L13		13,5		MHO 06 L20		20	
with pegs, side entry	CHO 06 L16		16		MHO 06 L25		25	
with pegs, side entry, high construction, without adaptor *	CFO 06 L21		21		MFO 06 L25		25	
with pegs, side entry, high construction, without adaptor *	CFO 06 L29		29		MFO 06 L32		32	
with pegs, top entry	CHV 06 L13		13,5		MHV 06 L20		20	
with pegs, top entry	CHV 06 L16		16		MHV 06 L25		25	
with pegs, top entry, high construction, without adaptor *	CFV 06 L21		21		MFV 06 L25		25	
with pegs, top entry, high construction, without adaptor *	CFV 06 L29		29		MFV 06 L32		32	
with single lever, top entry							JPV 06 LG16	16
with single lever (for hoods with pegs)							JPC 06 LG	
with pegs (for enclosures with single lever)							JMPV 06 LG25	25
							CHC 06 L	

* enclosure without adaptor, threaded on the body, to enclosure to be used only with a complete cable gland.

dimensions in mm

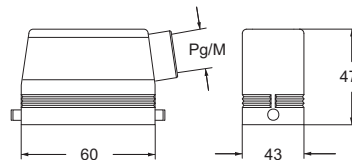
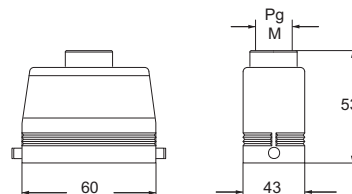
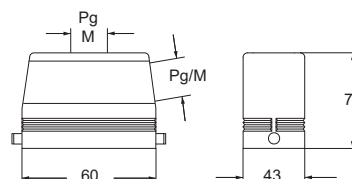
CHO L and MHO L

CHV L and MHV L

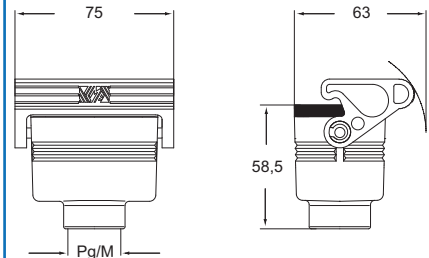
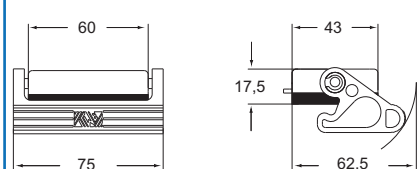
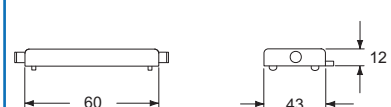
CFO L and MFO L - CFV L and MFV L

dimensions in mm

JPV LG and JMPV LG

JPC LG

CHC L

Type 4/4X/12

dimensions shown are not binding and may be changed without notice

inserts:	page:
CDD 42 poles + ⊕	42
JDS 18 poles + ⊕	55
JSH 10 poles + ⊕	63
JNE, JSE 10 poles + ⊕	69
CCE 10 poles + ⊕	75
CQE 18 poles + ⊕	82

insert centre distance:
57 x 27 mm

bulkhead mounting housings with 2 levers



thermoplastic lever

surface mounting housings with 2 levers



thermoplastic lever

description	part No.	part No.	entry Pg	part No.	entry M
with levers	JPI 10				
with levers		JPP 10.16	16	JMPP 10.20	20
with levers		JPP 10.216	16 x 2	JMPP 10.220	20 x 2
with levers, high construction		JPAP 10.21	21	JMPAP 10.32	32
with levers, high construction		JPAP 10.221	21 x 2	JMPAP 10.232	32 x 2

panel cut-out for bulkhead mounting housings in mm

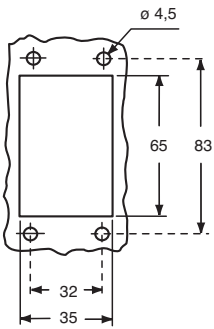

dimensions in mm

JPI

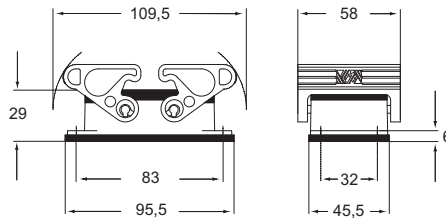

dimensions in mm

JPP - JPAP and JMPP - JMPAP

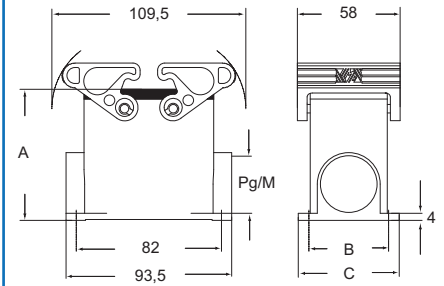

type	A	B	C
JPP - JMPP 10	57	40	52
JPAP - JMPAP 10	74	45	57

CALUS Type 4/4X/12

EAC



dimensions shown are not binding and may be changed without notice

inserts:	page:
CDD 42 poles + ⊕	42
JDS 18 poles + ⊕	55
JSH 10 poles + ⊕	63
JNE, JSE 10 poles + ⊕	69
CCE 10 poles + ⊕	75
CQE 18 poles + ⊕	82

 insert centre distance:
57 x 27 mm
hoods with 4 pegs

hoods with gasket and 2 levers covers with 4 pegs and 2 levers

 thermoplastic
 lever

description	part No.		part No.		part No.		part No.	
		entry Pg		entry M		entry Pg		entry M
with pegs, side entry	CHO 10	16	MHO 10.20	20				
with pegs, side entry			MHO 10.25	25				
with pegs, side entry, high construction	CAO 10.21	21	MAO 10.32	32				
with pegs, side entry, high construction	CAO 10.29	29	MAO 10.40	40				
with pegs, side entry, high construction, without adaptor *	CFO 10.21	21	MFO 10.25	25				
with pegs, side entry, high construction, without adaptor *	CFO 10.29	29	MFO 10.32	32				
with pegs, top entry	CHV 10	16	MHV 10.20**	20				
with pegs, top entry			MHV 10.25	25				
with pegs, top entry, high construction	CAV 10.21	21	MAV 10.32	32				
with pegs, top entry, high construction	CAV 10.29	29	MAV 10.40	40				
with pegs, top entry, high construction, without adaptor *	CFV 10.21	21	MFV 10.25	25				
with pegs, top entry, high construction, without adaptor *	CFV 10.29	29	MFV 10.32	32				
with levers, top entry					JPV 10 G16	16	JMPV 10 G25	25
with levers (for hoods with pegs)					JPC 10 G			
with pegs (for enclosures with levers and gasket)					CHC 10			

* enclosure without adaptor, threaded on the body, to enclosure to be used only with a complete cable gland.

** can only be used with a complete cable gland (to be purchased separately).

dimensions in mm

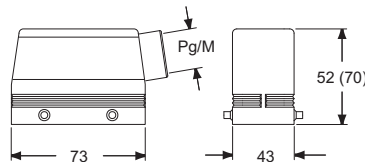
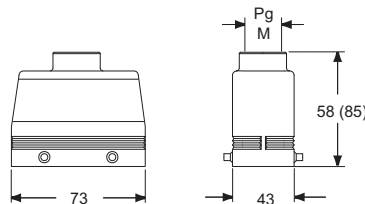
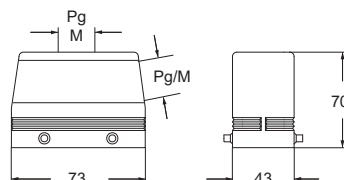
CHO (CAO) and MHO (MAO)

CHV (CAV) and MHV (MAV)

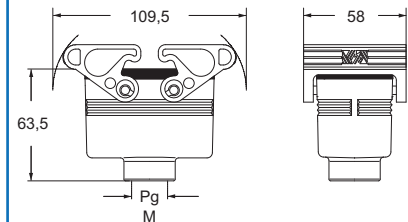
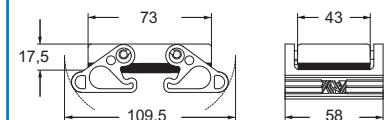
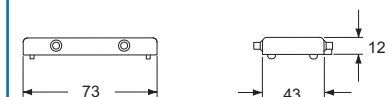
CFO - MFO and CFV - MFV

dimensions in mm

JPV G and JMPV G

JPC G

CHC

Type 4/4X/12

dimensions shown are not binding and may be changed without notice

inserts:	page:
CD 40 poles + ⊕	35
CDD 72 poles + ⊕	43
JDS 27 poles + ⊕	56
JSH 16 poles + ⊕	64
JNE, JSE 16 poles + ⊕	70
CCE 16 poles + ⊕	76
CQE 32 poles + ⊕	83

insert centre distance:
77,5 x 27 mm

bulkhead mounting housings with 2 levers



thermoplastic lever

surface mounting housings with 2 levers



thermoplastic lever

description	part No.	part No.	entry Pg	part No.	entry M
with levers	JPI 16				
with levers		JPP 16.21	21	JMPP 16.25	25
with levers		JPP 16.221	21 x 2	JMPP 16.225	25 x 2
with levers, high construction		JPAP 16.29	29	JMPAP 16.32	32
with levers, high construction		JPAP 16.229	29 x 2	JMPAP 16.232	32 x 2

panel cut-out for bulkhead mounting housings in mm

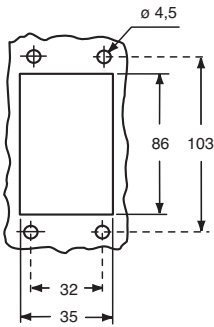

dimensions in mm

JPI

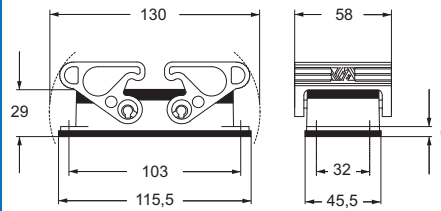

dimensions in mm

JPP - JPAP and JMPP - JMPAP

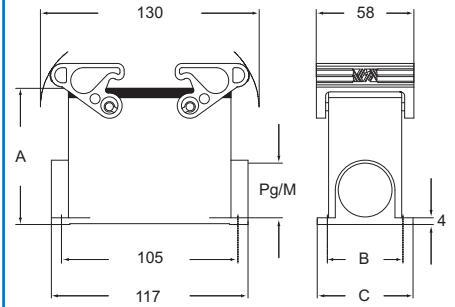

type	A	B	C
JPP - JMPP 16	63	45	57
JPAP - JMPAP 16	81	45	57

CE® Type 4/4X/12

EAC



dimensions shown are not binding and may be changed without notice

inserts:	page:
CD 40 poles + ⊕	35
CDD 72 poles + ⊕	43
JDS 27 poles + ⊕	56
JSH 16 poles + ⊕	64
JNE, JSE 16 poles + ⊕	70
CCE 16 poles + ⊕	76
CQE 32 poles + ⊕	83

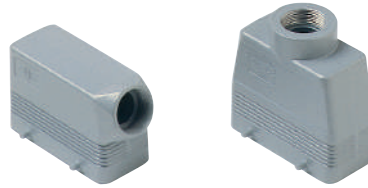
 insert centre distance:
77,5 x 27 mm
hoods with 4 pegs

hoods with gasket and 2 levers covers with 4 pegs and 2 levers



thermoplastic lever

description	part No.		part No.		part No.		part No.	
		entry Pg		entry M		entry Pg		entry M
with pegs, side entry	CHO 16	21	MHO 16.25	25				
with pegs, side entry			MHO 16.32	32				
with pegs, side entry, high construction	CAO 16.21	21	MAO 16.32	32				
with pegs, side entry, high construction	CAO 16.29	29	MAO 16.40	40				
with pegs, side entry, high construction, without adaptor *	CFO 16.21	21	MFO 16.25	25				
with pegs, side entry, high construction, without adaptor *	CFO 16.29	29	MFO 16.32	32				
with pegs, top entry	CHV 16	21	MHV 16.25 **	25				
with pegs, top entry			MHV 16.32	32				
with pegs, top entry, high construction	CAV 16.21	21	MAV 16.32	32				
with pegs, top entry, high construction	CAV 16.29	29	MAV 16.40	40				
with pegs, top entry, high construction, without adaptor *	CFV 16.21	21	MFV 16.32	32				
with pegs, top entry, high construction, without adaptor *	CFV 16.29	29	MFV 16.40	40				
with levers, top entry					JPV 16 G21	21	JMPV 16 G32	32
with levers (for hoods with pegs)					JPC 16 G			
with pegs (for enclosures with levers and gasket)					CHC 16			

* enclosure without adaptor, threaded on the body, to enclosure to be used only with a complete cable gland.

** can only be used with a complete cable gland (to be purchased separately).

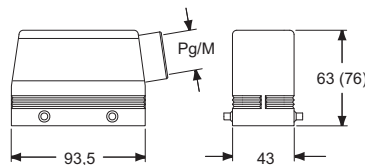
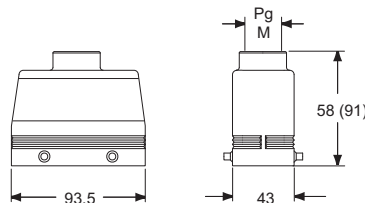
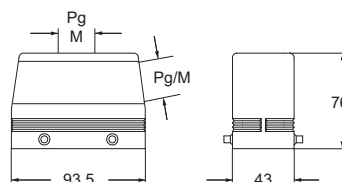
dimensions in mm

CHO (CAO) and MHO (MAO)

CHV (CAV) and MHV (MAV)

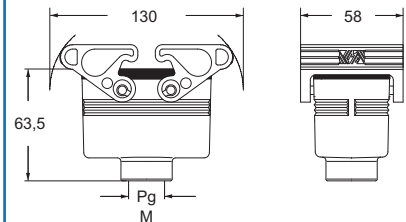
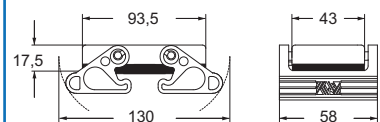
CFO - MFO and CFV - MFV

dimensions in mm

JPV G and JMPV G

JPC G

CHC

Type 4/4X/12



dimensions shown are not binding and may be changed without notice

inserts:	page:
CD 64 poles + ⊕	36
CDD 108 poles + ⊕	44
JDS 42 poles + ⊕	57
JSH 24 poles + ⊕	65
JNE, JSE 24 poles + ⊕	71
CCE 24 poles + ⊕	77
CQE 46 poles + ⊕	84

insert centre distance:
104 x 27 mm

bulkhead mounting housings with 2 levers



thermoplastic lever

surface mounting housings with 2 levers



thermoplastic lever

description	part No.	part No.	entry Pg	part No.	entry M
with levers	JPI 24				
with levers		JPP 24.21	21	JMPP 24.25	25
with levers		JPP 24.221	21 x 2	JMPP 24.225	25 x 2
with levers, high construction		JPAP 24.29	29	JMPAP 24.32	32
with levers, high construction		JPAP 24.229	29 x 2	JMPAP 24.232	32 x 2

panel cut-out for bulkhead mounting housings in mm

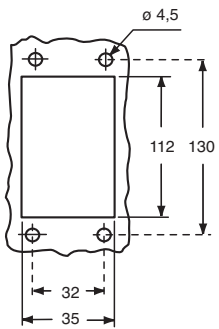

dimensions in mm

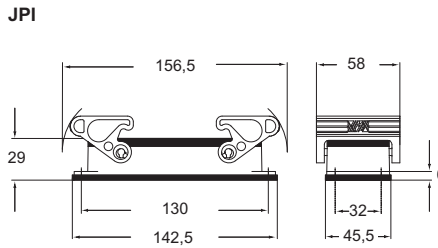

dimensions in mm

JPP - JPAP and JMPP - JMPAP

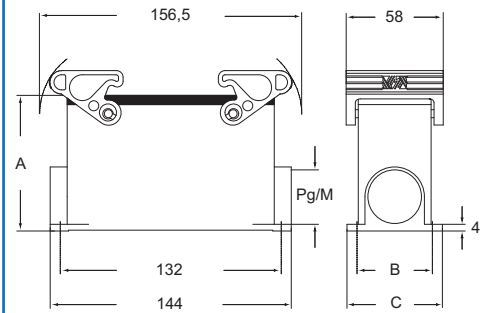

type	A	B	C
JPP - JMPP 24	63	45	57
JPAP - JMPAP 24	81	45	57

CALUS Type 4/4X/12

EAC



dimensions shown are not binding and may be changed without notice

inserts:	page:
CD 64 poles + ⊕	36
CDD 108 poles + ⊕	44
JDS 42 poles + ⊕	57
JSH 24 poles + ⊕	65
JNE, JSE 24 poles + ⊕	71
CCE 24 poles + ⊕	77
CQE 46 poles + ⊕	84

insert centre distance:
104 x 27 mm

hoods with 4 pegs



hoods with gasket and 2 levers covers with 4 pegs and 2 levers



thermoplastic lever

description	part No.		part No.		part No.		part No.	
		entry Pg		entry M		entry Pg		entry M
with pegs, side entry	CHO 24	21	MHO 24.25	25				
with pegs, side entry			MHO 24.32	32				
with pegs, side entry, high construction	CAO 24.21	21	MAO 24.32	32				
with pegs, side entry, high construction	CAO 24.29	29	MAO 24.40	40				
with pegs, side entry, high construction, without adaptor *	CFO 24.21	21	MFO 24.25	25				
with pegs, side entry, high construction, without adaptor *	CFO 24.29	29	MFO 24.32	32				
with pegs, top entry	CHV 24	21	MHV 24.25 **	25				
with pegs, top entry			MHV 24.32	32				
with pegs, top entry	CHV 24.29	29	MHV 24.40	40				
with pegs, top entry, high construction	CAV 24.21	21	MAV 24.32	32				
with pegs, top entry, high construction	CAV 24.29	29	MAV 24.40	40				
with pegs, top entry, high construction, without adaptor *	CFV 24.21	21	MFV 24.32	32				
with pegs, top entry, high construction, without adaptor *	CFV 24.29	29	MFV 24.40	40				
with levers, top entry					JPV 24 G21	21	JMPV 24 G32	32
with levers (for hoods with pegs)					JPC 24 G			
with pegs (for enclosures with levers and gasket)					CHC 24			

* enclosure without adaptor, threaded on the body, to enclosure to be used only with a complete cable gland.

** can only be used with a complete cable gland (to be purchased separately).

dimensions in mm

CHO (CAO) and MHO (MAO)

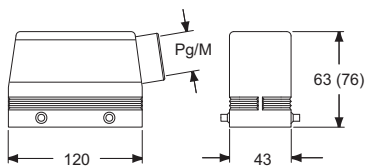

CHV (CAV) and MHV (MAV)

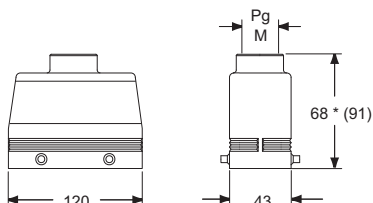

* 69,5 for Pg 29 - M 40 versions

CFO - MFO and CFV - MFV

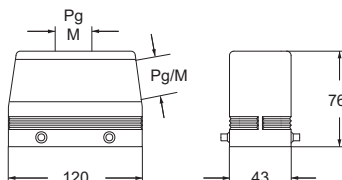

dimensions in mm

JPV G and JMPV G

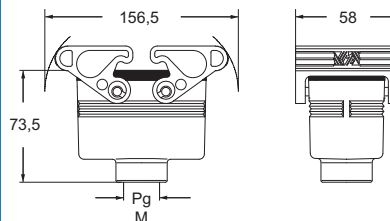

JPC G

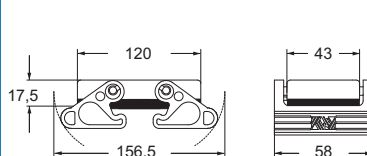

CHC

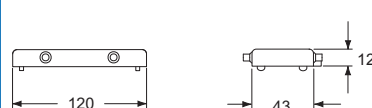

CALUS® Type 4/4X/12

EAC



dimensions shown are not binding and may be changed without notice

inserts:	page:
CD 80 poles + ⊕	37
CDD 144 poles + ⊕	45
JDS 54 poles + ⊕	58
JSH 32 poles + ⊕	66
JNE, JSE 32 poles + ⊕	72
CCE 32 poles + ⊕	78
CQE 64 poles + ⊕	85

insert centre distance:
2 x (77,5 x 27) mm

bulkhead mounting housings with 2 levers



thermoplastic lever

surface mounting housings with 2 levers



thermoplastic lever

description	part No.		part No.		part No.	
				entry Pg		entry M
with levers	JPI 32					
with levers			JPP 32.29	29	JMPP 32.40	40
with levers			JPP 32.229	29 x 2	JMPP 32.240	40 x 2
with levers			JPP 32.36	36		
with levers			JPP 32.236	36 x 2		

panel cut-out for bulkhead mounting housings in mm

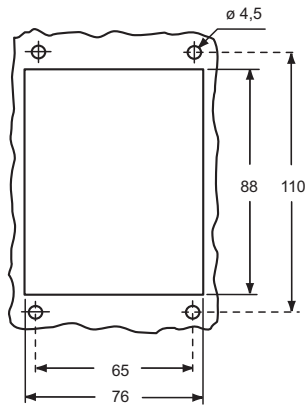

dimensions in mm

JPI

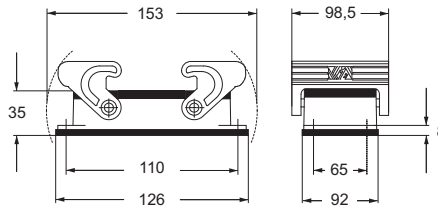

dimensions in mm

JPP and JMPP

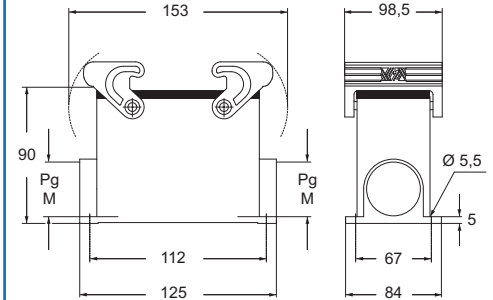

CE® Type 4/4X/12

EAC



dimensions shown are not binding and may be changed without notice

inserts: page:

CD	80 poles + ⊕	37
CDD	144 poles + ⊕	45
JDS	54 poles + ⊕	58
JSH	32 poles + ⊕	66
JNE, JSE	32 poles + ⊕	72
CCE	32 poles + ⊕	78
CQE	64 poles + ⊕	85

insert centre distance:
2 x (77,5 x 27) mm

hoods with 4 pegs



hoods with gasket and 2 levers covers with 4 pegs and 2 levers



thermoplastic lever

description	part No.		entry		part No.		entry	
			Pg	M			Pg	M
with pegs, side entry, without adaptor *	CFO 32.29		29		MFO 32.32		32	
with pegs, side entry, without adaptor *	CFO 32.36		36		MFO 32.40		40	
with pegs, top entry, without adaptor *	CFV 32.29		29		MFV 32.32		32	
with pegs, top entry, without adaptor *	CFV 32.36		36		MFV 32.40		40	
with levers, top entry, without adaptor *					JPFV 32 G36	36		JMPFV 32 G40 40
with levers (for hoods with pegs)					JPC 32 G			
with levers (for enclosures with levers and gasket)					CHC 32			

* enclosure without adaptor, threaded on the body, to enclosure to be used only with a complete cable gland.

dimensions in mm

CFO and MFO

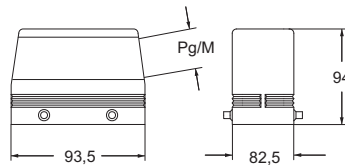

CFV and MFV

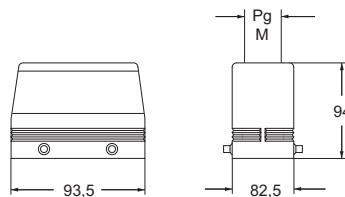

dimensions in mm

JPFV G and JMPFV G

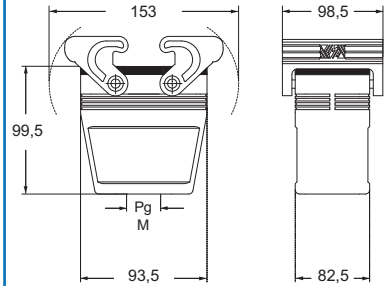

JPC G

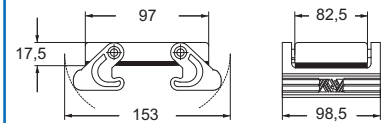

CHC

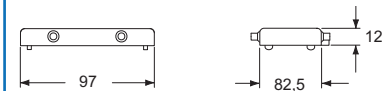

CE® Type 4/4X/12

EAC



dimensions shown are not binding and may be changed without notice

inserts:	page:
CDD 24 poles + ⊕	40
JDS 9 poles + ⊕	54
JSH 6 poles + ⊕	62
JNE, JSE 6 poles + ⊕	68
CCE 6 poles + ⊕	74
CQE 10 poles + ⊕	81

insert centre distance:
44 x 27 mm

bulkhead mounting housings with single lever



lever in galvanized steel

bulkhead mounting housings with single lever



lever in galvanized steel

description	part No.	part No.
with lever	JCVI 06 L	JCVI 06 LP
with lever and plastic cover		

panel cut-out for bulkhead mounting housings in mm

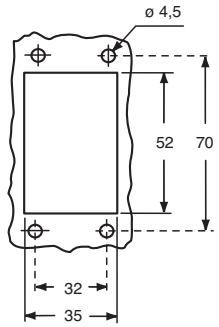

dimensions in mm

JCVI L

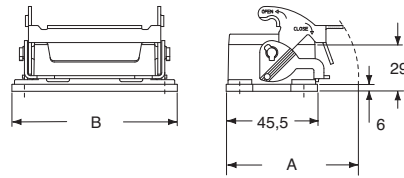

type	A	B
JCVI 06 L	66	82,5

dimensions in mm

JCVI LP

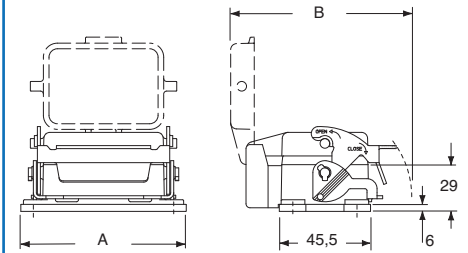

type	A	B
JCVI 06 LP	82,5	89

NB:
the enclosures ensure IP66 protection (or IP65 for cover versions) rating when mated and locked with the closing levers.

CE® Type 4/4X/12
(excluding enclosures with plastic cover)

EAC



dimensions shown are not binding and may be changed without notice

inserts: page:

CDD	24 poles + ⊕	40
JDS	9 poles + ⊕	54
JSH	6 poles + ⊕	62
JNE, JSE	6 poles + ⊕	68
CCE	6 poles + ⊕	74
CQE	10 poles + ⊕	81

insert centre distance:
44 x 27 mm

surface mounting housings with single lever



lever in galvanized steel

surface mounting housings with single lever



lever in galvanized steel

description	part No.	entry Pg
with lever and plastic cover	JCVP 06 LP	16
with lever and plastic cover	JCVP 06 LP2	16 x 2
with lever and plastic cover, high construction	JCVAP 06 LP	21
with lever and plastic cover, high construction	JCVAP 06 LP2	21 x 2
with lever		
with lever		
with lever, high construction		
with lever, high construction		

part No.	entry M	part No.	entry M
JMVP 06 LP20	20	JMVP 06LP220	20 x 2
JMVAP 06LP32	32	JMVAP06LP232	32 x 2

part No.	entry Pg	part No.	entry M
JCVP 06 L	16	JMVP 06 L20	20
JCVP 06 L2	16 x 2	JMVP 06 L220	20 x 2
JCVAP 06 L	21	JMVAP 06 L32	32
JCVAP 06 L2	21 x 2	JMVAP 06L232	32 x 2

NB:
the enclosures ensure IP66 protection (or IP65 for cover versions) rating when mated and locked with the closing levers.

dimensions in mm

JCVP LP - JCVAP LP and JMVP LP - JMVAP LP

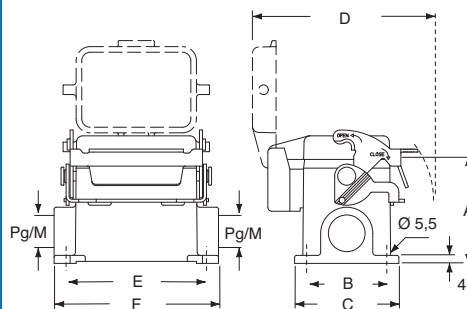

type	A	B	C	D	E	F
JCVP/JMVP 06 LP	53	40	52	91	70	82
JCVAP/JMVAP 06 LP	73	45	57	91	70	82

dimensions in mm

JCVP L - JCVAP L and JMVP L - JMVAP L

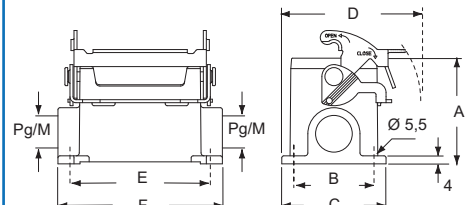

type	A	B	C	D	E	F
JCVP/JMVP 06 L	53	40	52	70	70	82
JCVAP/JMVAP 06 L	73	45	57	72,5	70	82

CRUS® Type 4/4X/12
(excluding enclosures with plastic cover)

EAC



dimensions shown are not binding and may be changed without notice

inserts:	page:
CDD 24 poles + ⊕	40
JDS 9 poles + ⊕	54
JSH 6 poles + ⊕	62
JNE, JSE 6 poles + ⊕	68
CCE 6 poles + ⊕	74
CQE 10 poles + ⊕	81

 insert centre distance:
44 x 27 mm
hoods with 2 pegs

covers with 2 pegs



description	part No.		part No.		part No.
		entry Pg		entry M	
with pegs, side entry	CHO 06 L13	13,5	MHO 06 L20	20	
with pegs, side entry	CHO 06 L16	16	MHO 06 L25	25	
with pegs, side entry, high construction, without adaptor *	CFO 06 L21	21	MFO 06 L25	25	
with pegs, side entry, high construction, without adaptor *	CFO 06 L29	29	MFO 06 L32	32	
with pegs, top entry	CHV 06 L13	13,5	MHV 06 L20	20	
with pegs, top entry	CHV 06 L16	16	MHV 06 L25	25	
with pegs, top entry, high construction, without adaptor *	CFV 06 L21	21	MFV 06 L25	25	
with pegs, top entry, high construction, without adaptor *	CFV 06 L29	29	MFV 06 L32	32	
with pegs (for enclosures with single lever)					CHC 06 L

* enclosure without adaptor, threaded on the body, to enclosure to be used only with a complete cable gland.

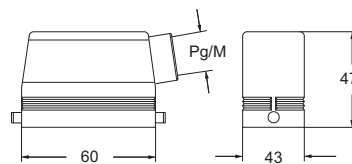
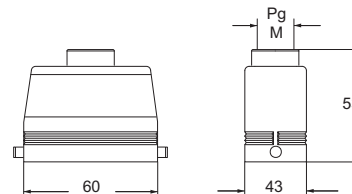
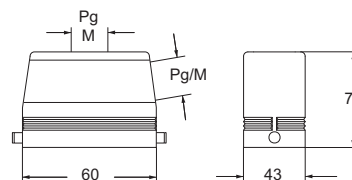
dimensions in mm

CHO L and MHO L

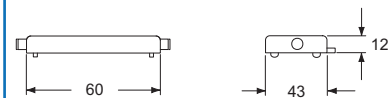
CHV L and MHV L

CFO L and MFO L - CFV L and MFV L

dimensions in mm

CHC L

Type 4/4X/12



dimensions shown are not binding and may be changed without notice

inserts:	page:
CDD 42 poles + ⊕	42
JDS 18 poles + ⊕	55
JSH 10 poles + ⊕	63
JNE, JSE 10 poles + ⊕	69
CCE 10 poles + ⊕	75
CQE 18 poles + ⊕	82

insert centre distance:
57 x 27 mm

bulkhead mounting housings with single lever

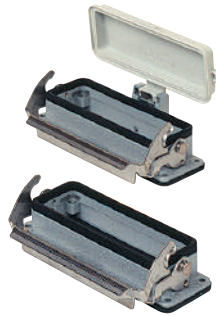

lever in galvanized steel

bulkhead mounting housings with 2 levers

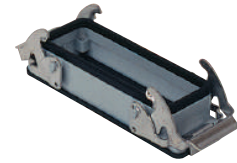

lever in galvanized steel

description	part No.	part No.
with lever	JCVI 10 L	
with lever and plastic cover	JCVI 10 LP	
with levers		JCVI 10

panel cut-out for bulkhead mounting housings in mm

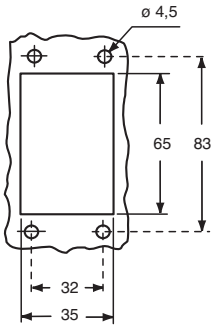

dimensions in mm

JCVI L

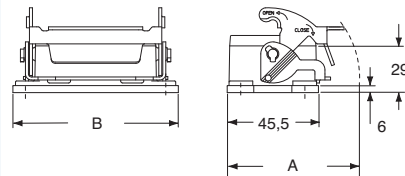

JCVI LP

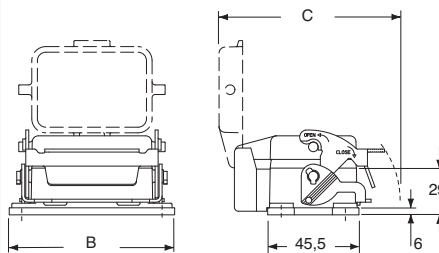

type	A	B	C
JCVI 10 L	70	95,5	-
JCVI 10 LP	-	95,5	94

dimensions in mm

JCVI

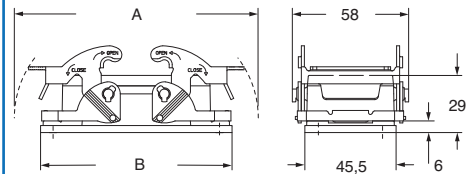

type	A	B
JCVI 10	122	95,5

NB:
the enclosures ensure IP66 protection (or IP65 for cover versions) rating when mated and locked with the closing levers.

CRUS® Type 4/4X/12
(excluding enclosures with plastic cover)



dimensions shown are not binding and may be changed without notice

inserts: page:

CDD	42 poles + ⊕	42
JDS	18 poles + ⊕	55
JSH	10 poles + ⊕	63
JNE, JSE	10 poles + ⊕	69
CCE	10 poles + ⊕	75
CQE	18 poles + ⊕	82

 insert centre distance:
57 x 27 mm
surface mounting housings with 2 levers

 lever in
 galvanized
 steel

description	part No.	entry	part No.	entry
		Pg		M
with levers	JCVP 10	16	JMVP 10.20	20
with levers	JCVP 10.2	16 x 2	JMVP 10.220	20 x 2
with levers, high construction	JCVAP 10.21	21	JMVAP 10.32	32
with levers, high construction	JCVAP 10.221	21 x 2	JMVAP 10.232	32 x 2

dimensions in mm

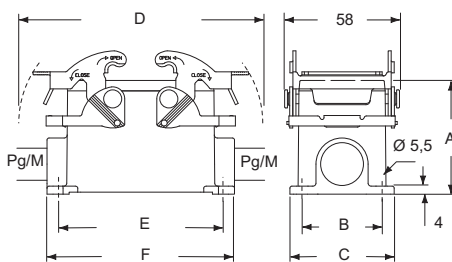
JCVP - JCVAP and JMVP - JMVAP

type	A	B	C	D	E	F
JCVP/JMVP 10	57	40	52	122	82	93,5
JCVAP/JMVAP 10	73	45	57	122	82	93,5

 Type
 4/4X/12

 dimensions shown are not binding
 and may be changed without notice

inserts:	page:
CDD 42 poles + ⊕	42
JDS 18 poles + ⊕	55
JSH 10 poles + ⊕	63
JNE, JSE 10 poles + ⊕	69
CCE 10 poles + ⊕	75
CQE 18 poles + ⊕	82

insert centre distance:
57 x 27 mm

surface mounting housings with single lever

lever in galvanized steel

surface mounting housings with single lever

lever in galvanized steel

description	part No.		part No.		part No.		part No.	
		entry Pg		entry M		entry Pg		entry M
with lever and plastic cover	JCVP 10 LP	16	JMVP 10 LP20	20				
with lever and plastic cover	JCVP 10 LP2	16 x 2	JMVP 10LP220	20 x 2				
with lever and plastic cover, high construction	JCVAP 10LP21	21	JMVAP 10LP32	32				
with lever and plastic cover, high construction	JCVAP10LP221	21 x 2	JMVAP10LP232	32 x 2				
with lever					JCVP 10 L	16	JMVP 10 L20	20
with lever					JCVP 10 L2	16 x 2	JMVP 10 L220	20 x 2
with lever, high construction					JCVAP 10 L21	21	JMVAP 10 L32	32
with lever, high construction					JCVAP 10L221	21 x 2	JMVAP 10L232	32 x 2

NB:
the enclosures ensure IP66 protection (or IP65 for cover versions) rating when mated and locked with the closing levers.

dimensions in mm

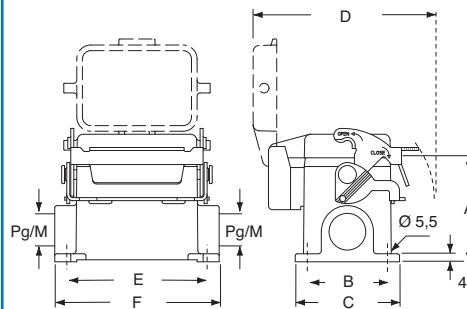
JCVP LP - JCVAP LP and JMVP LP - JMVAP LP

type	A	B	C	D	E	F
JCVP/JMVP 10 LP	57	40	52	94	82	93,5
JCVAP/JMVAP 10 LP	73	45	57	94	82	93,5

dimensions in mm

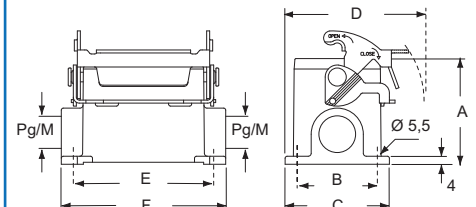
JCVP L - JCVAP L and JMVP L - JMVAP L

type	A	B	C	D	E	F
JCVP/JMVP 10 L	57	40	52	73	82	93,5
JCVAP/JMVAP 10 L	73	45	57	75,5	82	93,5

CRUS® Type 4/4X/12
(excluding enclosures with plastic cover)

EAC



dimensions shown are not binding and may be changed without notice

inserts:	page:
CDD 42 poles + ⊕	42
JDS 18 poles + ⊕	55
JSH 10 poles + ⊕	63
JNE, JSE 10 poles + ⊕	69
CCE 10 poles + ⊕	75
CQE 18 poles + ⊕	82

insert centre distance:
57 x 27 mm

hoods with 4 pegs

hoods with 2 pegs



description	part No.		part No.		part No.		part No.	
		entry Pg		entry M		entry Pg		entry M
with pegs, side entry	CHO 10	16	MHO 10.20	20	CHO 10 L	16	MHO 10 L20	20
with pegs, side entry			MHO 10.25	25			MHO 10 L25	25
with pegs, side entry, high construction	CAO 10.21	21	MAO 10.32	32	CAO 10 L21	21	MAO 10 L32	32
with pegs, side entry, high construction	CAO 10.29	29	MAO 10.40	40	CAO 10 L29	29	MAO 10 L40	40
with pegs, top entry	CHV 10	16	MHV 10.20 *	20	CHV 10 L	16	MHV 10 L20 *	20
with pegs, top entry			MHV 10.25	25			MHV 10 L25	25
with pegs, top entry, high construction	CAV 10.21	21	MAV 10.32	32	CAV 10 L21	21	MAV 10 L32	32
with pegs, top entry, high construction	CAV 10.29	29	MAV 10.40	40	CAV 10 L29	29	MAV 10 L40	40

* can only be used with a complete cable gland (to be purchased separately).

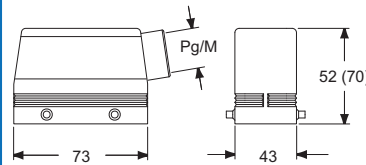
dimensions in mm

CHO (CAO) and MHO (MAO)

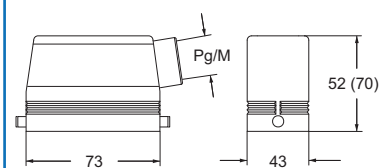
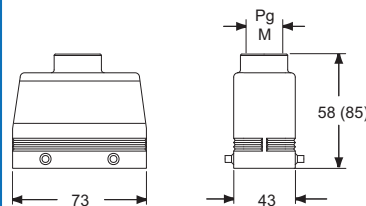
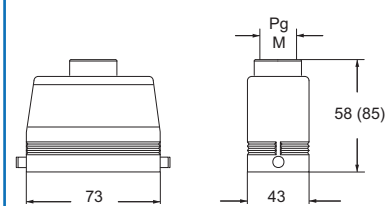
dimensions in mm

CHO L (CAO L) and MHO L (MAO L)

CHV (CAV) and MHV (MAV)

CHV L (CAV L) and MHV L (MAV L)

CALUS® Type 4/4X/12

EAC



according to the type of lever

dimensions shown are not binding and may be changed without notice

inserts: page:

CDD	42 poles + ⊕	42
JDS	18 poles + ⊕	55
JSH	10 poles + ⊕	63
JNE, JSE	10 poles + ⊕	69
CCE	10 poles + ⊕	75
CQE	18 poles + ⊕	82

insert centre distance:
57 x 27 mm

covers with 2 pegs



covers with 4 pegs



description

part No.

part No.

with 2 pegs (for enclosures with 1 lever and gasket)

CHC 10 L

with 4 pegs (for enclosures with 2 levers and gasket)

CHC 10

NB:
the enclosures ensure IP66 protection (or IP65 for cover versions) rating when mated and locked with the closing levers.

dimensions in mm

CHC L

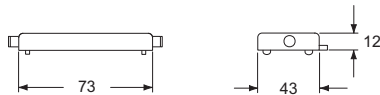

dimensions in mm

CHC

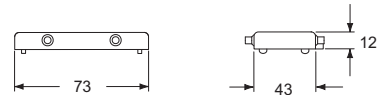

CRAUS Type 4/4X/12

EAC



dimensions shown are not binding
and may be changed without notice

inserts:	page:
CD 40 poles + ⊕	35
CDD 72 poles + ⊕	43
JDS 27 poles + ⊕	56
JSH 16 poles + ⊕	64
JNE, JSE 16 poles + ⊕	70
CCE 16 poles + ⊕	76
CQE 32 poles + ⊕	83

insert centre distance:
77,5 x 27 mm

bulkhead mounting housings with single lever

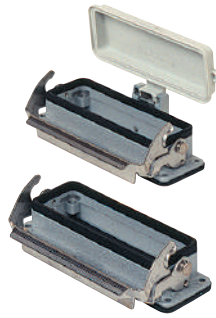

lever in galvanized steel

bulkhead mounting housings with 2 levers

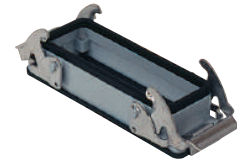

lever in galvanized steel

description	part No.	part No.
with lever	JCVI 16 L	
with lever and plastic cover	JCVI 16 LP	
with levers		JCVI 16

panel cut-out for bulkhead mounting housings in mm

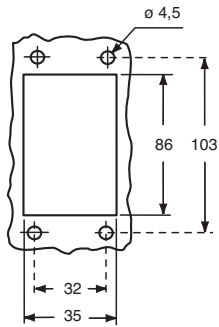

NB:
the enclosures ensure IP66 protection (or IP65 for cover versions) rating when mated and locked with the closing levers.

dimensions in mm

JCVI L

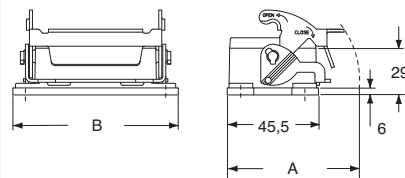

JCVI LP

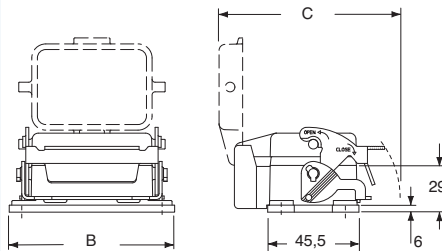

type	A	B	C
JCVI 16 L	70	115,5	-
JCVI 16 LP	-	115,5	94

dimensions in mm

JCVI

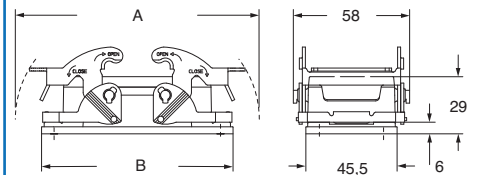

type	A	B
JCVI 16	142,5	115,5

CAVUS® Type 4/4X/12
(excluding enclosures with plastic cover)



dimensions shown are not binding and may be changed without notice

inserts: page:

CD	40 poles + ⊕	35
CDD	72 poles + ⊕	43
JDS	27 poles + ⊕	56
JSH	16 poles + ⊕	64
JNE, JSE	16 poles + ⊕	70
CCE	16 poles + ⊕	76
CQE	32 poles + ⊕	83

insert centre distance:
77,5 x 27 mm

surface mounting housings
with 2 levers



lever in
galvanized
steel

description	part No.	entry	part No.	entry
		Pg		M
with levers	JCVP 16	21	JMVP 16.25	25
with levers	JCVP 16.2	21 x 2	JMVP 16.225	25 x 2
with levers, high construction	JCVAP 16.29	29	JMVAP 16.32	32
with levers, high construction	JCVAP 16.229	29 x 2	JMVAP 16.232	32 x 2

dimensions in mm

JCVP - JCVAP and JMVP - JMVAP

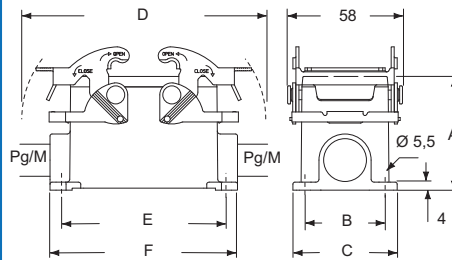

type	A	B	C	D	E	F
JCVP/JMVP 16	63	45	57	142,5	105	117
JCVAP/JMVAP 16	77	45	57	142,5	105	117

CAVUS® Type 4/4X/12

EAC



dimensions shown are not binding
and may be changed without notice

inserts:	page:
CD 40 poles + ⊕	35
CDD 72 poles + ⊕	43
JDS 27 poles + ⊕	56
JSH 16 poles + ⊕	64
JNE, JSE 16 poles + ⊕	70
CCE 16 poles + ⊕	76
CQE 32 poles + ⊕	83

insert centre distance:
77,5 x 27 mm

surface mounting housings
with single lever



lever in
galvanized
steel

surface mounting housings
with single lever



lever in
galvanized
steel

description	part No.		part No.		part No.		part No.	
		entry Pg		entry M		entry Pg		entry M
with lever and plastic cover	JCVP 16 LP	21	JMVP 16 LP25	25				
with lever and plastic cover	JCVP 16 LP2	21 x 2	JMVP 16LP225	25 x 2				
with lever and plastic cover, high construction	JCVAP 16LP29	29	JMVAP 16LP32	32				
with lever and plastic cover, high construction	JCVAP16LP229	29 x 2	JMVAP16LP232	32 x 2				
with lever					JCVP 16 L	21	JMVP 16 L25	25
with lever					JCVP 16 L2	21 x 2	JMVP 16 L225	25 x 2
with lever, high construction					JCVAP 16 L29	29	JMVAP 16 L32	32
with lever, high construction					JCVAP 16L229	29 x 2	JMVAP 16L232	32 x 2

NB:
the enclosures ensure IP66 protection (or IP65 for cover versions) rating when mated and locked with the closing levers.

dimensions in mm

JCVP LP - JCVAP LP and JMVP LP - JMVAP LP

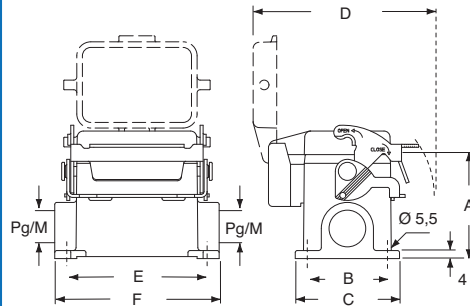

type	A	B	C	D	E	F
JCVP/JMVP 16 LP	63	45	57	94	105	117
JCVAP/JMVAP 16 LP	77	45	57	94	105	117

dimensions in mm

JCVP L - JCVAP L and JMVP L - JMVAP L

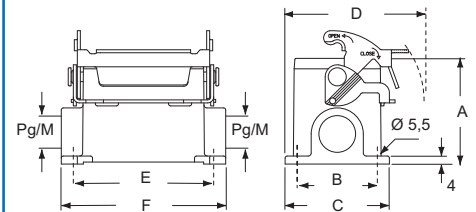

type	A	B	C	D	E	F
JCVP/JMVP 16 L	63	45	57	75,5	105	117
JCVAP/JMVAP 16 L	77	45	57	75,5	105	117

CAVUS® Type
4/4X/12
(excluding enclosures with plastic cover)



dimensions shown are not binding
and may be changed without notice

inserts:	page:
CD 40 poles + ⊕	35
CDD 72 poles + ⊕	43
JDS 27 poles + ⊕	56
JSH 16 poles + ⊕	64
JNE, JSE 16 poles + ⊕	70
CCE 16 poles + ⊕	76
CQE 32 poles + ⊕	83

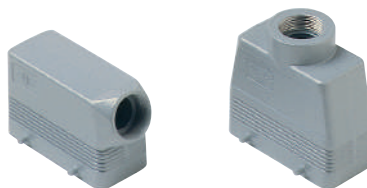
 insert centre distance:
77,5 x 27 mm
hoods with 4 pegs

hoods with 2 pegs

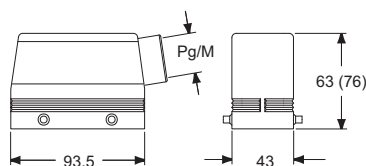

description	part No.		part No.		part No.		part No.	
		entry Pg		entry M		entry Pg		entry M
with pegs, side entry	CHO 16	21	MHO 16.25	25	CHO 16 L	21	MHO 16 L25	25
with pegs, side entry			MHO 16.32	32			MHO 16 L32	32
with pegs, side entry, high construction	CAO 16.21	21	MAO 16.32	32	CAO 16 L21	21	MAO 16 L32	32
with pegs, side entry, high construction	CAO 16.29	29	MAO 16.40	40	CAO 16 L29	29	MAO 16 L40	40
with pegs, top entry	CHV 16	21	MHV 16.25 *	25	CHV 16 L	21	MHV 16 L25	25
with pegs, top entry			MHV 16.32	32			MHV 16 L32	32
with pegs, top entry, high construction	CAV 16.21	21	MAV 16.32	32	CAV 16 L21	21	MAV 16 L32	32
with pegs, top entry, high construction	CAV 16.29	29	MAV 16.40	40	CAV 16 L29	29	MAV 16 L40	40

* can only be used with a complete cable gland (to be purchased separately).

dimensions in mm

CHO (CAO) and MHO (MAO)

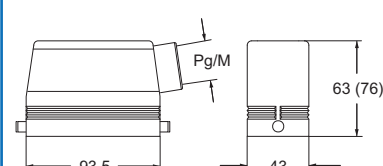
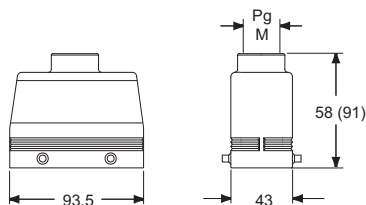
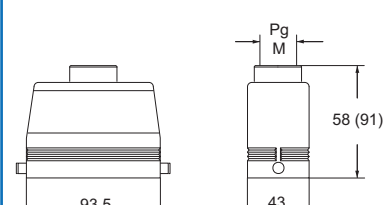
dimensions in mm

CHO L (CAO L) and MHO L (MAO L)

CHV (CAV) and MHV (MAV)

CHV L (CAV L) and MHV L (MAV L)

Type 4/4X/12

according to the type of lever

 dimensions shown are not binding
 and may be changed without notice

inserts:		page:
CD	40 poles + ⊕	35
CDD	72 poles + ⊕	43
JDS	27 poles + ⊕	56
JSH	16 poles + ⊕	64
JNE, JSE	16 poles + ⊕	70
CCE	16 poles + ⊕	76
CQE	32 poles + ⊕	83

insert centre distance:
77,5 x 27 mm

covers with 2 pegs



covers with 4 pegs



description	part No.	part No.
with 2 pegs (for enclosures with 1 lever and gasket)	CHC 16 L	
with 4 pegs (for enclosures with 2 levers and gasket)		CHC 16

NB:
the enclosures ensure IP66 protection (or IP65 for cover versions) rating when mated and locked with the closing levers.

dimensions in mm

CHC L

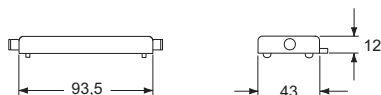

dimensions in mm

CHC



CRAUS® Type 4/4X/12

EAC



dimensions shown are not binding
and may be changed without notice

inserts:	page:
CD 64 poles + ⊕	36
CDD 108 poles + ⊕	44
JDS 42 poles + ⊕	57
JSH 24 poles + ⊕	65
JNE, JSE 24 poles + ⊕	71
CCE 24 poles + ⊕	77
CQE 46 poles + ⊕	84

insert centre distance:
104 x 27 mm

bulkhead mounting housings with single lever

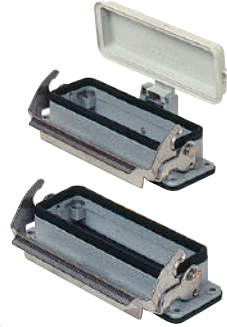

lever in galvanized steel

bulkhead mounting housings with 2 levers



lever in galvanized steel

description	part No.	part No.
with lever	JCVI 24 L	
with lever and plastic cover	JCVI 24 LP	
with levers		JCVI 24

panel cut-out for bulkhead mounting housings in mm

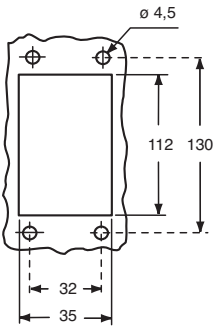

NB:
the enclosures ensure IP66 protection (or IP65 for cover versions) rating when mated and locked with the closing levers.

dimensions in mm

JCVI L

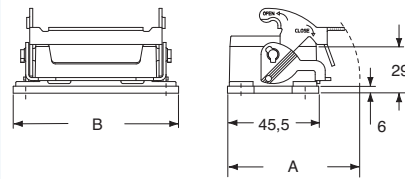

JCVI LP

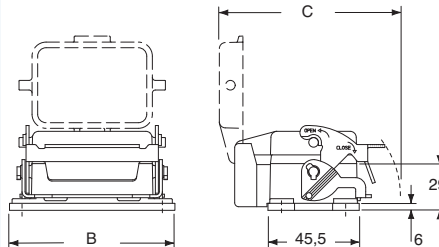

type	A	B	C
JCVI 24 L	70	142,5	-
JCVI 24 LP	-	142,5	94

dimensions in mm

JCVI

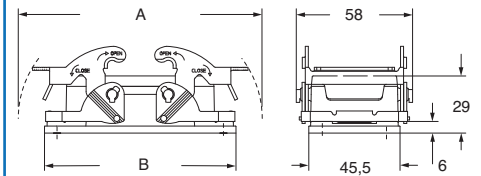

type	A	B
JCVI 24	169	142,5

CRUS® Type 4/4X/12
(excluding enclosures with plastic cover)

EAC



dimensions shown are not binding and may be changed without notice

inserts: page:

CD	64 poles + ⊕	36
CDD	108 poles + ⊕	44
JDS	42 poles + ⊕	57
JSH	24 poles + ⊕	65
JNE, JSE	24 poles + ⊕	71
CCE	24 poles + ⊕	77
CQE	46 poles + ⊕	84

 insert centre distance:
104 x 27 mm
surface mounting housings with 2 levers

 lever in
galvanized
steel

description	part No.	entry	part No.	entry
		Pg		M
with levers	JCVP 24	21	JMVP 24.25	25
with levers	JCVP 24.2	21 x 2	JMVP 24.225	25 x 2
with levers, high construction	JCVAP 24.29	29	JMVAP 24.32	32
with levers, high construction	JCVAP 24.229	29 x 2	JMVAP 24.232	32 x 2

dimensions in mm

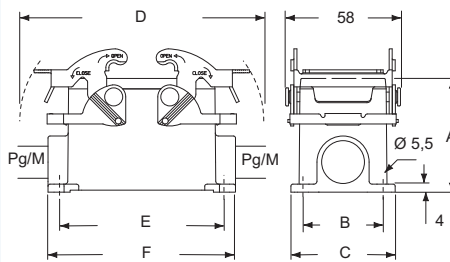
JCVP - JCVAP and JMVP - JMVAP

type	A	B	C	D	E	F
JCVP/JMVP 24	63	45	57	169	132	144
JCVAP/JMVAP 24	80	45	57	169	132	144

Type 4/4X/12

 dimensions shown are not binding
 and may be changed without notice

inserts:	page:
CD 64 poles + ⊕	36
CDD 108 poles + ⊕	44
JDS 42 poles + ⊕	57
JSH 24 poles + ⊕	65
JNE, JSE 24 poles + ⊕	71
CCE 24 poles + ⊕	77
CQE 46 poles + ⊕	84

insert centre distance:
104 x 27 mm

surface mounting housings with single lever

lever in galvanized steel

surface mounting housings with single lever

lever in galvanized steel

description	part No.		part No.		part No.		part No.	
		entry Pg		entry M		entry Pg		entry M
with lever and plastic cover	JCVP 24 LP	21	JMVP 24 LP25	25				
with lever and plastic cover	JCVP 24 LP2	21 x 2	JMVP 24LP225	25 x 2				
with lever and plastic cover, high construction	JCVAP 24LP29	29	JMVAP 24LP32	32				
with lever and plastic cover, high construction	JCVAP24LP229	29 x 2	JMVAP24LP232	32 x 2				
with lever					JCVP 24 L	21	JMVP 24 L25	25
with lever					JCVP 24 L2	21 x 2	JMVP 24 L225	25 x 2
with lever, high construction					JCVAP 24 L29	29	JMVAP 24 L32	32
with lever, high construction					JCVAP 24L229	29 x 2	JMVAP 24L232	32 x 2

NB:
the enclosures ensure IP66 protection (or IP65 for cover versions) rating when mated and locked with the closing levers.

dimensions in mm

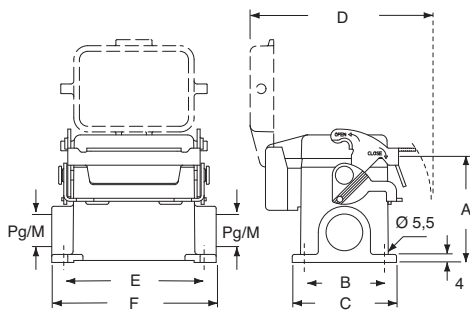
JCVP LP - JCVAP LP and JMVP LP - JMVAP LP

type	A	B	C	D	E	F
JCVP/JMVP 24 LP	63	45	57	94	132	144
JCVAP/JMVAP 24 LP	80	45	57	94	132	144

dimensions in mm

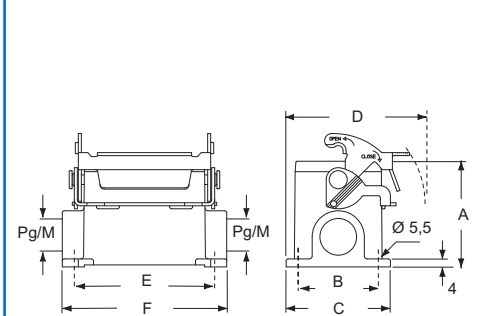
JCVP L - JCVAP L and JMVP L - JMVAP L

type	A	B	C	D	E	F
JCVP/JMVP 24 L	63	45	57	75,5	132	144
JCVAP/JMVAP 24 L	80	45	57	75,5	132	144

CRUS® Type 4/4X/12
(excluding enclosures with plastic cover)



dimensions shown are not binding and may be changed without notice

inserts: page:

CD	64 poles + ⊕	36
CDD	108 poles + ⊕	44
JDS	42 poles + ⊕	57
JSH	24 poles + ⊕	65
JNE, JSE	24 poles + ⊕	71
CCE	24 poles + ⊕	77
CQE	46 poles + ⊕	84

 insert centre distance:
104 x 27 mm
hoods with 4 pegs

hoods with 2 pegs



description	part No.		part No.		part No.		part No.	
		entry Pg		entry M		entry Pg		entry M
with pegs, side entry	CHO 24	21	MHO 24.25	25	CHO 24 L	21	MHO 24 L25	25
with pegs, side entry			MHO 24.32	32			MHO 24 L32	32
with pegs, side entry, high construction	CAO 24.21	21	MAO 24.32	32	CAO 24 L21	21	MAO 24 L32	32
with pegs, side entry, high construction	CAO 24.29	29	MAO 24.40	40	CAO 24 L29	29	MAO 24 L40	40
with pegs, top entry	CHV 24	21	MHV 24.25 *	25	CHV 24 L	21	MHV 24 L25	25
with pegs, top entry			MHV 24.32	32			MHV 24 L32	32
con piolini, uscita verticale	CHV 24.29	29	MHV 24.40	40	CHV 24 L29	29	MHV 24 L40	40
with pegs, top entry, high construction	CAV 24.21	21	MAV 24.32	32	CAV 24 L21	21	MAV 24 L32	32
with pegs, top entry, high construction	CAV 24.29	29	MAV 24.40	40	CAV 24 L29	29	MAV 24 L40	40

* can only be used with a complete cable gland (to be purchased separately).

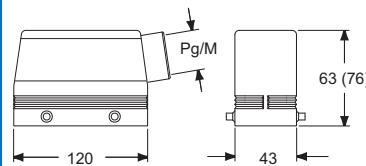
dimensions in mm

CHO (CAO) and MHO (MAO)

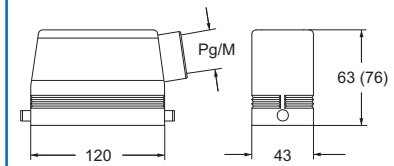
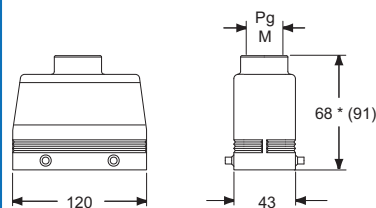
dimensions in mm

CHO L (CAO L) and MHO L (MAO L)

CHV (CAV) and MHV (MAV)

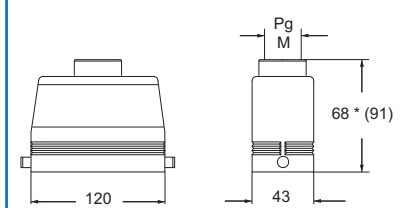
* 69,5 for Pg 29 - M 40 versions

CHV L (CAV L) and MHV L (MAV L)

* 69,5 for Pg 29 - M 40 versions

Type 4/4X/12

according to the type of lever

 dimensions shown are not binding
 and may be changed without notice

inserts:		page:
CD	64 poles + ⊕	36
CDD	108 poles + ⊕	44
JDS	42 poles + ⊕	57
JSH	24 poles + ⊕	65
JNE, JSE	24 poles + ⊕	71
CCE	24 poles + ⊕	77
CQE	46 poles + ⊕	84

insert centre distance:
104 x 27 mm

covers with 2 pegs



covers with 4 pegs



description

part No.

part No.

with 2 pegs (for enclosures with 1 lever and gasket)

CHC 24 L

with 4 pegs (for enclosures with 2 levers and gasket)

CHC 24

NB:
the enclosures ensure IP66 protection (or IP65 for cover versions) rating when mated and locked with the closing levers.

dimensions in mm

dimensions in mm

CHC L

CHC

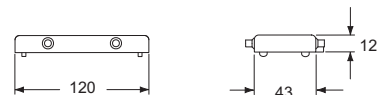
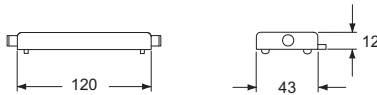

CE **US** Type 4/4X/12

EAC



dimensions shown are not binding
and may be changed without notice

inserts:	page:
CD 80 poles + ⊕	37
CDD 144 poles + ⊕	45
JDS 54 poles + ⊕	58
JSH 32 poles + ⊕	66
JNE, JSE 32 poles + ⊕	72
CCE 32 poles + ⊕	78
CQE 64 poles + ⊕	85

insert centre distance:
2 x (77,5 x 27) mm

bulkhead mounting housings with single lever



surface mounting housings with single lever



description	part No.	part No.	entry Pg	part No.	entry M
with lever	JCHI 32 L				
with lever and plastic cover	JCHI 32 LP				
with lever		JCHP 32 L29	29	JMHP 32 L40	40
with lever		JCHP 32 L229	29 x 2	JMHP 32 L240	40 x 2
with lever		JCHP 32 L36	36	JMHP 32 L50	50
with lever		JCHP 32 L236	36 x 2	JMHP 32 L250	50 x 2
with lever and plastic cover		JCHP 32 LP29	29	JMHP 32 LP40	40
with lever and plastic cover		JCHP 32LP229	29 x 2	JMHP 32LP240	40 x 2
with lever and plastic cover		JCHP 32 LP36	36	JMHP 32 LP50	50
with lever and plastic cover		JCHP 32 LP2	36 x 2	JMHP 32LP250	50 x 2

panel cut-out for bulkhead mounting housings in mm

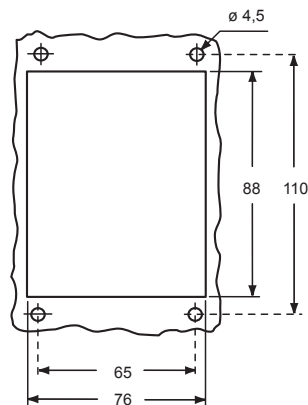

dimensions in mm

JCHI L and JCHI LP

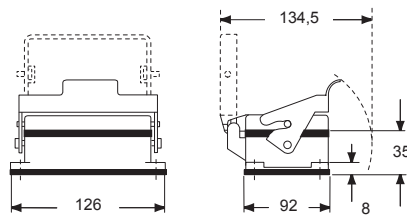

dimensions in mm

JCHP L - JMHP P and JCHP LP - JMHP LP

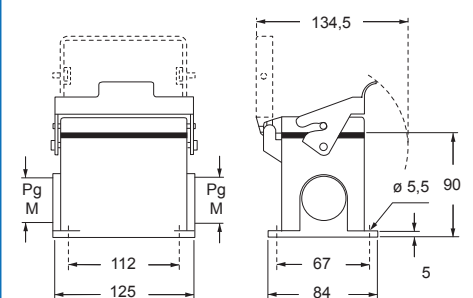

NB:
the enclosures ensure IP66 protection (or IP65 for cover versions) rating when mated and locked with the closing levers.

CE® **US** Type 4/4X/12
(excluding enclosures with plastic cover)

EAC



dimensions shown are not binding and may be changed without notice

inserts:	page:
CD 80 poles + ⊕	37
CDD 144 poles + ⊕	45
JDS 54 poles + ⊕	58
JSH 32 poles + ⊕	66
JNE, JSE 32 poles + ⊕	72
CCE 32 poles + ⊕	78
CQE 64 poles + ⊕	85

insert centre distance:
2 x (77,5 x 27) mm

hoods with 2 pegs



covers with 2 pegs



description	part No.		part No.		part No.
		entry Pg		entry M	
with pegs, side entry, without adaptor *	CFO 32 L	36	MFO 32 L40	40	
with pegs, top entry, without adaptor *	CFV 32 L	36	MFV 32 L40	40	
with 2 pegs (for enclosures with 1 lever and gasket)					CHC 32 L

* enclosure without adaptor, threaded on the body, to enclosure to be used only with a complete cable gland.

dimensions in mm

CFO L and MFO L

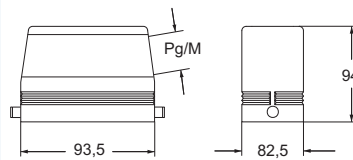

CFV L and MFV L

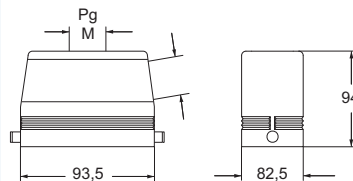

dimensions in mm

CHC L

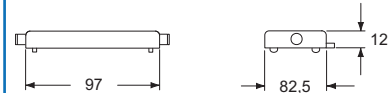

CE® **US** Type 4/4X/12

EAC



dimensions shown are not binding and may be changed without notice

inserts:	page:
CD 128 poles + ⊕	38
CDD 216 poles + ⊕	46
JDS 84 poles + ⊕	59
JSH 48 poles + ⊕	67
JNE, JSE 48 poles + ⊕	73
CCE 48 poles + ⊕	79
CQE 92 poles + ⊕	86

insert centre distance:
2 x (104 x 27) mm

bulkhead and surface mounting enclosures with single lever

hoods with 2 pegs



description	part No.		part No.		part No.		part No.	
	entry Pg	entry M	entry Pg	entry M	entry Pg	entry M	entry Pg	entry M
bulkhead mounting enclosures with lever	JCHI 48 L		---					
bulkhead mounting enclosures with lever and plastic cover	JCHI 48 LP		---					
custodie da parete con leva	JCHP 48 L29		29 x 1/2	JMHP 48 L40	40 x 1/2			
custodie da parete con leva	JCHP 48 L36		36 x 1/2	JMHP 48 L50	50 x 1/2			
surface mounting enclosures with lever and plastic cover	JCHP 48 LP29		29 x 1/2	JMHP 48 LP40	40 x 1/2			
surface mounting enclosures with lever and plastic cover	JCHP 48 LP36		36 x 1/2	JMHP 48 LP50	50 x 1/2			
with pegs, side entry, without adaptor *					CFO 48 L29	29	MFO 48 L32	32
with pegs, side entry, without adaptor *					CFO 48 L	36	MFO 48 L40	40
with pegs, side entry, without adaptor *					CFO 48 L42	42	MFO 48 L50	50
with pegs, top entry, without adaptor *					CFV 48 L29	29	MFV 48 L32	32
with pegs, top entry, without adaptor *					CFV 48 L	36	MFV 48 L40	40
with pegs, top entry, without adaptor *					CFV 48 L42	42	MFV 48 L50	50

* enclosure without adaptor, threaded on the body, to be used only with a complete cable gland.

dimensions in mm

dimensions in mm

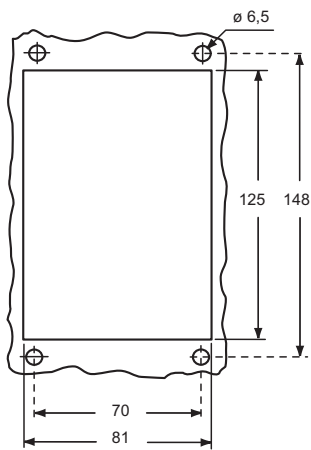
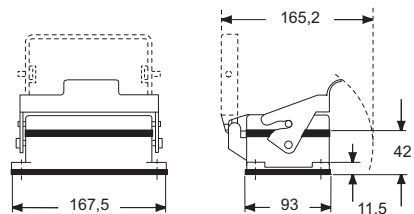
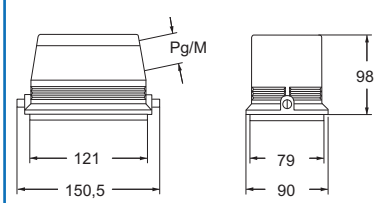
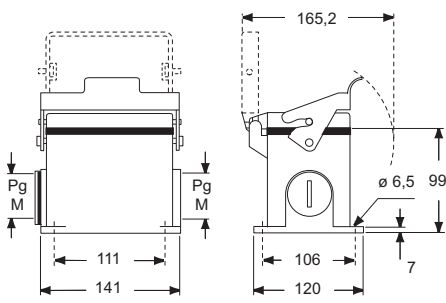
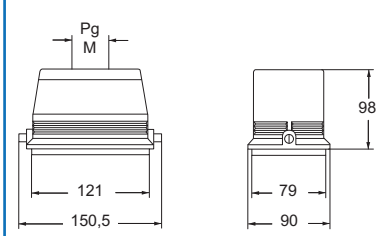
panel cut-out for bulkhead mounting housings in mm

JCVI L - LP

CFO L and MFO L

JCVP L - LP and JMVP L - LP

CFV L and MFV L

NB: the enclosures ensure IP66 protection (or IP65 for cover versions) rating when mated and locked with the closing levers.

CRUS® Type 4/4X/12
 (excluding enclosures with plastic cover)



dimensions shown are not binding and may be changed without notice

inserts:		page:
JK	3 poles + ⊕	27
JK	4 poles + ⊕	27
JKS	3 poles + ⊕	29
JKS	4 poles + ⊕	29
CD	7 poles + ⊕	31
CD	8 poles + ⊕	32

insert dimensions:
21 x 21 mm

bulkhead mounting housings

angled bulkhead mounting housings

description	part No.	part No. (entry - Pg 11)	part No. (entry - M 20)
with lever	CK 03 I (white)		
with lever	CK 03 IN (black)		
without cable entry, with lever		CK 03 IA (white)	
without cable entry, with lever		CK 03 IAN (black)	
with cable entry and lever		CK 03 IAPS (white)	MK IAP20 (white)
with cable entry and lever		CK 03 IAPNS (black)	MK IAPN20 (black)
gasket and screw kit for IP66/IP67 ¹⁾ for JK, JKS inserts	CKR 65	CKR 65	
gasket and screw kit for IP66/IP67 ¹⁾ for CD 07/08 inserts	CKR 65 D	CKR 65 D	

panel cut-out for enclosures, in mm

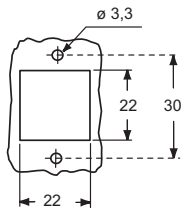

1) To obtain the protection rating IP66/IP67 a kit is provided that includes a gasket to fit under the insert fixing screws supplied with the kit (see illustrative example).

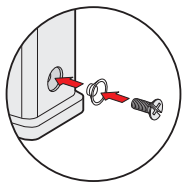

dimensions in mm

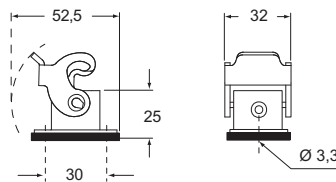
CK I(N)

dimensions in mm

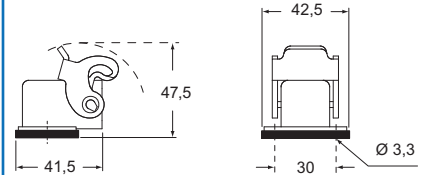
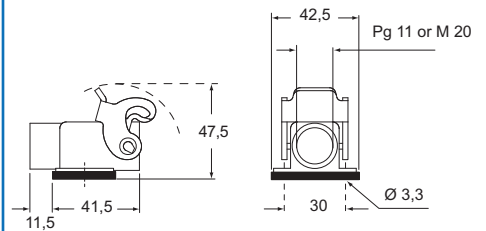
CK IA(N)

CK IAP(N)S and MK IAP(N)

Type 12
Type 4/4X only
with CKR 65 (D)



IP66/IP67 with CKR 65 (D) ¹⁾

dimensions shown are not binding
and may be changed without notice

inserts:		page:
JK	3 poles + ⊕	27
JK	4 poles + ⊕	27
JKS	3 poles + ⊕	29
JKS	4 poles + ⊕	29
CD	7 poles + ⊕	31
CD	8 poles + ⊕	32

insert dimensions:
21 x 21 mm

hoods

covers

description	part No. (entry - Pg 11)	part No. (entry - M 20)	part No.
with pegs, top entry	CK 03 VS (white)	MK V20 (white)	
with pegs, top entry	CK 03 VNS (black)	MK VN20 (black)	
with pegs, side entry	CK 03 VAS (white)	MK VA20 (white)	
with pegs, side entry	CK 03 VANS (black)	MK VAN20 (black)	
with lever, top entry	CK 03 VGS (white)	MK VG20 (white)	
with lever, top entry	CK 03 VGNS (black)	MK VGN20 (black)	
with pegs and gasket, for female inserts			CK 03 C (white)
with pegs and gasket, for female inserts			CK 03 CN (black)
with pegs, for male inserts			CK 03 CA (white)
with pegs, for male inserts			CK 03 CAN (black)
with lever and gasket, for female inserts			CK 03 CX (white)
with lever and gasket, for female inserts			CK 03 CXN (black)
with lever, for male inserts			CK 03 CXA (white)
with lever, for male inserts			CK 03 CXAN (black)
gasket and screw kit for IP66/IP67 ¹⁾ for JK, JKS inserts	CKR 65		
gasket and screw kit for IP66/IP67 ¹⁾ for CD 07/08 inserts	CKR 65 D		

1) To obtain the protection rating IP66/IP67 a kit is provided that includes a gasket to fit under the insert fixing screws supplied with the kit (see illustrative example).

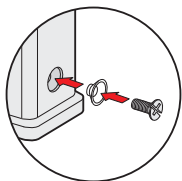

dimensions in mm

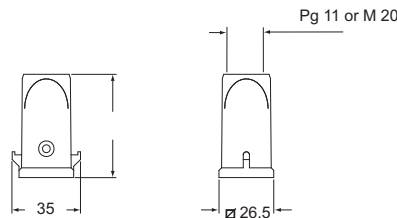
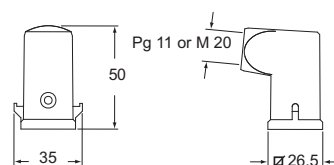
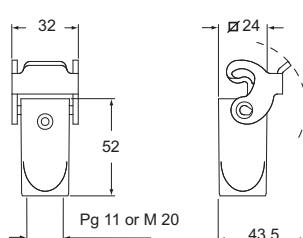
CK V(N)S and MK V(N)

CK VA(N)S and MK VA(N)

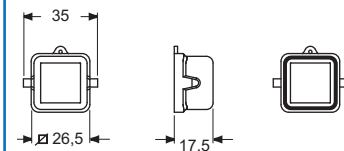
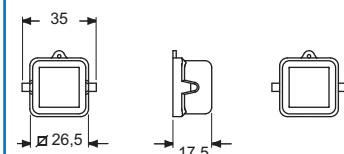
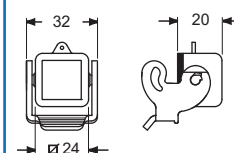
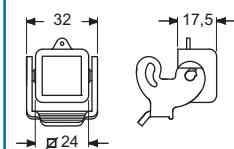
CK VG(N)S and MK VG(N)

dimensions in mm

CK C(N)

CK CA(N)

CK CX(N)

CK CXA(N)

Type 12
Type 4/4X only
with CKR 65 (D)



IP66/IP67 with CKR 65 (D) ¹⁾

dimensions shown are not binding
and may be changed without notice

inserts:	page:
JK 3 poles + ⊕	27
JK 4 poles + ⊕	27
JKS 3 poles + ⊕	29
JKS 4 poles + ⊕	29
CD 8 poles + ⊕	32

insert dimensions:
21 x 21 mm

bulkhead mounting housings

angled bulkhead mounting housings

description	part No.	part No. (entry - Pg 11)	part No. (entry - M 20)
with galvanised steel lever	CKA 03 I		
without cable entry, galvanized steel lever		CKA 03 IA	
with cable entry, galvanized steel lever		CKA 03 IAPS	MKA IAP20
with cable entry, galvanized steel lever, bulkhead hole closed		CKA 03 APS	MKA AP20
gasket and screw kit for IP66/IP67 ¹⁾ for JK, JKS inserts	CKR 65	CKR 65	
gasket and screw kit for IP66/IP67 ¹⁾ for CD 08 inserts	CKR 65 D	CKR 65 D	

panel cut-out for enclosures, in mm

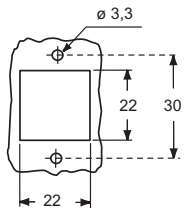

dimensions in mm

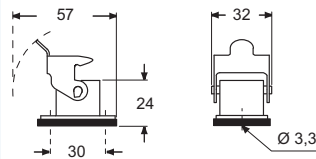
CKA I

dimensions in mm

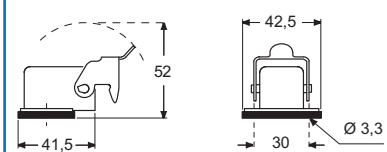
CKA IA

1) To obtain the protection rating IP66/IP67 a kit is provided that includes a gasket to fit under the insert fixing screws supplied with the kit (see illustrative example).

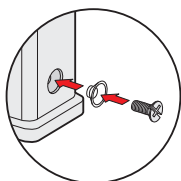
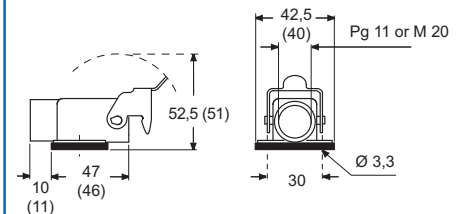
CKA IAPS (CKA APS) and MKA IAP (MKA AP)

Type 12
Type 4/4X only
with CKR 65 (D)



IP66/IP67 with CKR 65 (D) ¹⁾

dimensions shown are not binding
and may be changed without notice

inserts:	page:
JK 3 poles + ⊕	27
JK 4 poles + ⊕	27
JKS 3 poles + ⊕	29
JKS 4 poles + ⊕	29
CD 8 poles + ⊕	32

insert dimensions:
21 x 21 mm

angled bulkhead mounting housings

bulkhead mounting housings with cover



description	part No.	part No.
galvanized steel lever, M20 fixing thread ⁽¹⁾	MKA IAF20 ¹⁾	
galvanized steel lever, M25 fixing thread ⁽¹⁾	MKA IAF25 ¹⁾	
with galvanised steel lever, for female inserts with galvanised steel lever, for male inserts		CKA 03 ILS CKA 03 ILSA
gasket and screw kit for IP66/IP67 ¹⁾ for JK, JKS inserts	CKR 65	CKR 65
gasket and screw kit for IP66/IP67 ¹⁾ for CD 08 inserts	CKR 65 D	CKR 65 D

⁽¹⁾locknut supplied on request, see catalogue cable glands (articles AS M20N and AS M25N metallic, AS M20L and AS M25L insulating)

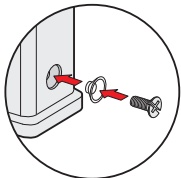
1) To obtain the protection rating IP66/IP67 a kit is provided that includes a gasket to fit under the insert fixing screws supplied with the kit (see illustrative example).

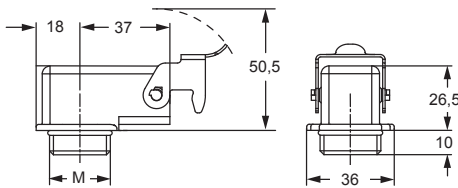

dimensions in mm

MKA IAF

panel cut-out

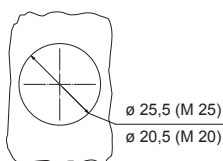

dimensions in mm

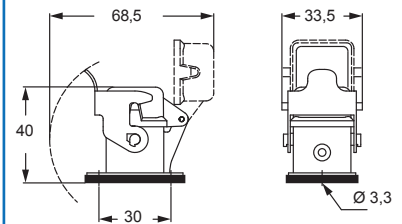
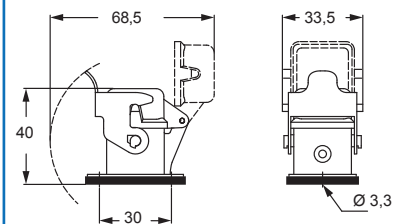
CKA ILS

CKA ILSA

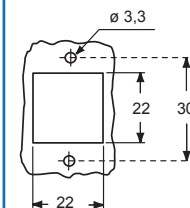
panel cut-out for bulkhead mounting housings in mm



Type 12
Type 4/4X only
with CKR 65 (D)



IP66/IP67 with CKR 65 (D) ¹⁾

le misure indicate non sono impegnative
e possono essere variate senza alcun preavviso

inserts:

page:

JK	3 poles + ⊕	27
JK	4 poles + ⊕	27
JKS	3 poles + ⊕	29
JKS	4 poles + ⊕	29
CD	8 poles + ⊕	32

 insert dimensions:
21 x 21 mm
hoods

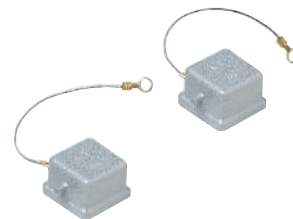
covers

description	part No. (entry - Pg 11)	part No. (entry - M 20)	part No.
with pegs, top entry	CKA 03 VS	MKA V20	
with pegs, side entry	CKA 03 VAS	MKA VA20	
with galvanised steel lever, top entry	CKA 03 VGS	MKA VG20	
with pegs and gasket, for female inserts			CKA 03 C
with pegs, for male inserts			CKA 03 CA
gasket and screw kit for IP66/IP67 ¹⁾ for JK, JKS inserts	CKR 65		
gasket and screw kit for IP66/IP67 ¹⁾ for CD 08 inserts	CKR 65 D		

1) To obtain the protection rating IP66/IP67 a kit is provided that includes a gasket to fit under the insert fixing screws supplied with the kit (see illustrative example).

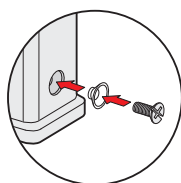

dimensions in mm

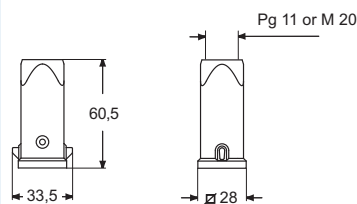
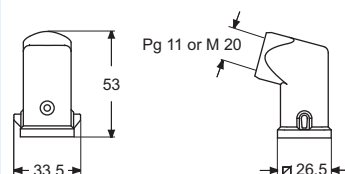
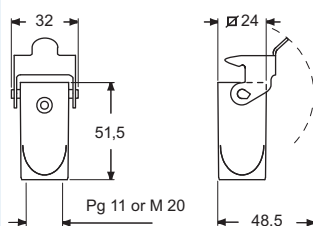
CKA VS and MKA V

CKA VAS and MKA VA

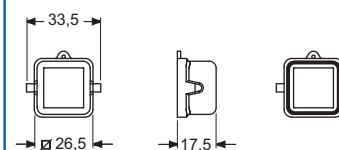
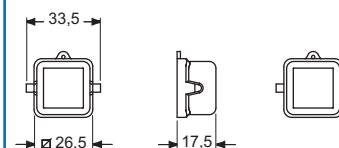
CKA VGS and MKA VG

dimensions in mm

CKA C

CKA CA

 Type 12
 Type 4/4X only
 with CKR 65 (D)

 IP44 IP66/IP67 with CKR 65 (D) ¹⁾

 dimensions shown are not binding
 and may be changed without notice



T-TYPE





“T-TYPE” series

Insulating enclosures



“T-TYPE” enclosures for standard and modular inserts



Alongside the wide range of traditional metallic enclosures for ILME multipole connectors, there is now available a **new series of enclosures in self-extinguishing thermoplastic material** in the most common sizes of “44.27”, “57.27”, “77.27” and “104.27”.

Quality and low cost are the main features of these enclosures, as an outcome of careful product studies.

Valuable characteristics of these new enclosures:

- **significant structural solidity** and mechanical robustness by virtue of **substantial thickness**;
- **resistance to the main chemical agents**, found in industrial environments;
- **external dimensions** of the bulkhead mounting housings are **similar to those of the corresponding metallic enclosures**; **hole fixing centres are unchanged**.

“T-TYPE” insulating enclosures

- **pre-fastened gaskets** for easier installation;
- **ample space inside enclosures** for cables, with mounted connectors, similar to the corresponding metal high construction versions;
- possibility of making **completely insulated** constructions (equivalent to Class II) □;
- **absence of powder paint** for environments in which these are not recommended;
- **non-electrostatic** thermoplastic material;



- the **surface mounting** high construction housings are supplied **with an open threaded entry** and diametrically opposite a closed threaded entry, which can be **opened** by the user, if required (with suitable tool);
- manufactured from insulating material, do not require **special reinforced insulation** as the metal versions do, for use with series **CME higher voltage** connector inserts (screw-type terminals);
- each enclosure carries its own part number and conformity markings.

For standard applications.

The standard version is characterized by:

- enclosures in RAL 7012 thermoplastic material with substantial thickness that provide structural solidity and robustness;
- gaskets pre-fastened;
- levers in thermoplastic material grey RAL 7001;
- threaded cable entries M25, M32 and M40;
- degree of protection IP65 (according to EN 60529);
- degree of protection UL TYPE 12 (according to ANSI/UL50);
- each enclosure carries the marks:
part number, thread and degree of protection UL.

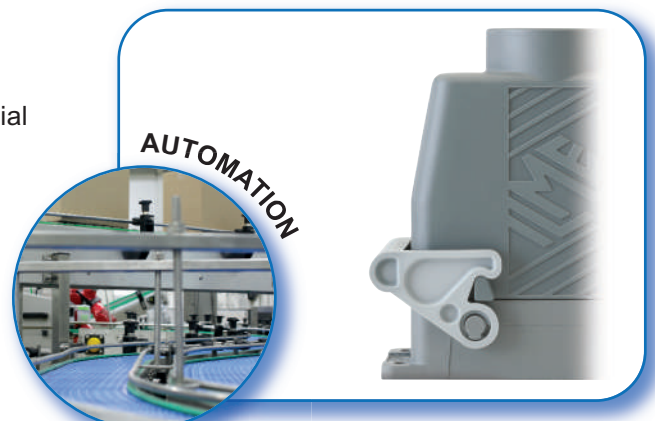

“T-TYPE” enclosures for completely insulated constructions

Featuring an original design, construction types available are:

bulkhead mounting housings



surface mounting housings
(with double entry of which one closed but threaded)



hoods
with levers



covers
with levers (for hoods)

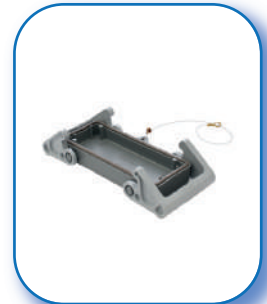

hoods
with side entry



hoods
with top entry



covers
(for housings)

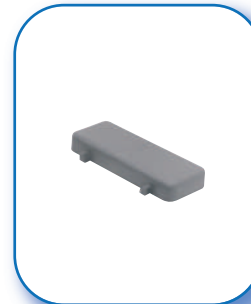

single lever, side and top entry,
for size “44.27”

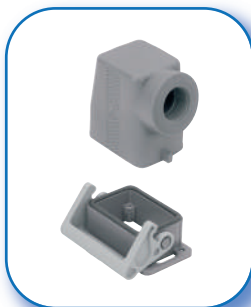

double lever, side and top entry,
for other sizes “57.27, 77.27, 104.27”



All used materials conform with the **RoHS II 2011/65/UE Directive** and subsequent modifications.

“T-TYPE” series insulating enclosures

1. Construction

Using the BC-MUL® moulding technique and use of MIL.BOX® material, these enclosures are structurally solid and mechanically robust, due to their increased thickness. They are particularly resistant to the main pollutants present in industrial environments. The lever enclosure pegs are built into the enclosures. The methods for fastening the connectors to the enclosures are made of M3 threaded metal inserts.

With reference to metal construction, which to comply with electrical installation safety norms, must be earthed via a metal connection to the grounding terminal of the inserts inside the enclosure, the new series of enclosures offers a solution for total insulation constructions (equivalent to class II) where necessary.

The thermoplastic material used is RAL 7012 dark grey colour and **UL 94V-2** grade self-extinguishing and has passed glow wire testing in accordance with the IEC (EN) 60695-2-11 at **650 °C** in compliance with intended uses.

2. Gaskets

Gaskets have been produced by means of the FIPFG technology (Formed-In-Place-Foam-Gasket).

They have therefore been incorporated in the base flange on bulkhead mounting housings for easier installation.

3. Levers

The locking levers have been produced in self-extinguishable thermoplastic material coloured grey RAL 7001.

4. Dimensions

The internal dimensions allow mounting of all connector inserts in their relevant sizes. The external dimensions of the bulkhead mounting housings are similar to those of the corresponding metallic enclosures; hole fixing centres are unchanged.

Hoods offer an inner cabling space similar to that of the “high” construction models of the corresponding metal enclosures. Other characteristics are in compliance with the applicable safety standard for electrical connectors, **IEC/EN 61984**.

5. Cable entries

The housing and hood cable entries are available with metric thread, respectively:

- **M25** or **M32** for smaller sizes “44.27” and “57.27”.
- **32** or **M40** for larger sizes “77.27” and “104.27”.

The surface mounting, high construction housings are supplied with an open threaded entry and diametrically opposite a closed threaded entry which can be opened by the user if required (with suitable tool).

The recent standard **IEC/EN 61076-7-100** regarding metric cable entries for multipole electrical connectors for heavy duty uses, which standardises some main dimensions for entries and their related accessories (gaskets, pressure nuts), have been carefully considered in the product design.

6. Markings

Each enclosure carries its own part number and conformity markings.

Interchangeability with other ILME series

TCH series housings can be coupled with metal hoods. Insulating hoods can be coupled with “V-Type” metal housings. Hoods “57.27”, “77.27” and “104.07” can be mounted on **COB TCQ** and **COB BC** frames simply by replacing the supplied levers with **COB L** levers (to be purchased separately).

Insulating enclosures are ideal for mounting of all ILME inserts with the exception of series models CT 40/ 64 and CTS 40/ 64 connector. Inserts with 45° terminals of the CTE series (screw-type terminals) and CTSE (spring terminals) are only insertable from the front (therefore not from the back) of the bulkhead mounting housings. Being made by insulating material, they do not require a special reinforced insulation as metal ones do, for use with series CME higher voltage connector inserts (screw-type terminals). With the exception of the limitations described below, it is generally possible to mount the MIXO series modular connectors and frames with the ground and screen anchors dedicated to this series.

Limitations

With respect to enclosures in metal alloy, ILME insulating enclosures have some limitations of use in combination with particular accessories:

- CRZ 06/ 10/ 16/ 24 reduction plates cannot be mounted with TCHI bulkhead mounting housings due to increased dimensions of the fastening flange of these insulating enclosures.
- The CYG 16 in-line joint cannot be mounted on the TCHI 16 bulkhead mounting housings because the gaskets of the latter do not fit together with the joint profile.
- The CYR 16.3 and CYR 24.4 round cable feed-throughs are difficult to position on their respective TCHI 16 and TCHI 24 bulkhead mounting housings.
- CPT 24 disposable protection cover cannot be mounted on insulating enclosures due to increased outer dimensions of these enclosures.
- MIXO series insert anchors cannot be mounted on TMAO 06/ 10 enclosures.
- MIXO series insert anchors cannot be mounted on TMAO 06/ 10 enclosures.
- When using both cable entries of surface mounting housings, the conduit shall be of insulating type



inserts: page:

CDD	24 poles + ⊕	40
JDS	9 poles + ⊕	54
JSH	6 poles + ⊕	62
JNE, JSE	6 poles + ⊕	68
CCE	6 poles + ⊕	74
CQE	10 poles + ⊕	81

insert centre distance:
44 x 27 mm

housings with single lever



hoods with 2 pegs



description	part No.	entry M	part No.	entry M
bulkhead mounting housing with thermoplastic lever	TCHI 06 L			
surface mounting housing with thermoplastic lever	TMAP 06 L25	25		
surface mounting housing with thermoplastic lever	TMAP 06 L32	32		
with pegs, side entry			TMAO 06 L25	25
with pegs, side entry			TMAO 06 L32	32
with pegs, top entry			TMAV 06 L25	25
with pegs, top entry			TMAV 06 L32	32

panel cut-out for bulkhead mounting housing in mm

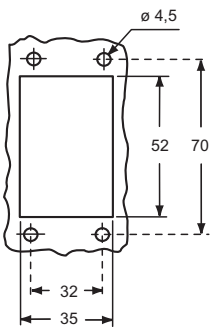

dimensions in mm

TCHI 06 L

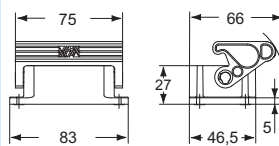

dimensions in mm

TMAO 06 L25 and TMAO 06 L32

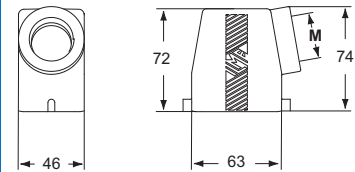

TMAP 06 L25 and TMAP 06 L32

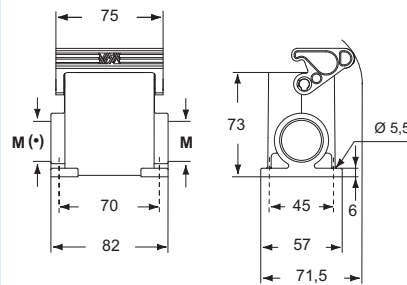

TMAV 06 L25 and TMAV 06 L32

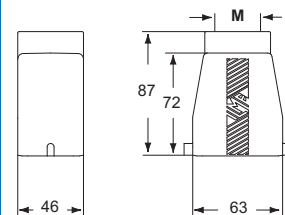

(*) The surface mounting, high construction housings are supplied with an open threaded entry (*) and diametrically opposite a closed threaded entry which can be opened by the user if required (with suitable tool).

CAIUS Type 12

EAC



- ambient temperature limits -40 °C / +90 °C.

dimensions shown are not binding
and may be changed without notice

inserts: page:

CDD	24 poles + ⊕	40
JDS	9 poles + ⊕	54
JSH	6 poles + ⊕	62
JNE, JSE	6 poles + ⊕	68
CCE	6 poles + ⊕	74
CQE	10 poles + ⊕	81

 insert centre distance:
44 x 27 mm
**hoods with single lever
top entry**

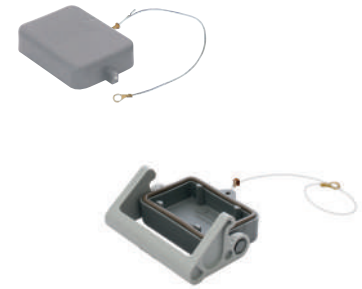
covers

description	part No.	entry M	part No.
with thermoplastic lever and gasket	TMAV 06 LG25	25	
with thermoplastic lever and gasket	TMAV 06 LG32	32	
with pegs			TCHC 06 L
with thermoplastic lever and gasket			TCHC 06 LG

dimensions in mm

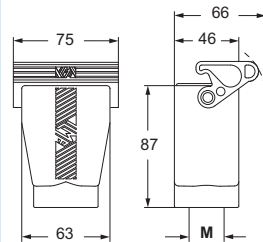
TMAV 06 LG25 and TMAV 06 LG32

dimensions in mm

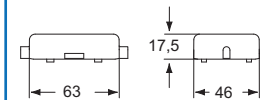
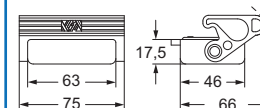
TCHC 06 L

TCHC 06 LG

Type 12



- ambient temperature limits -40 °C / +90 °C.

 dimensions shown are not binding
 and may be changed without notice

inserts: page:

CDD	42 poles + ⊕	42
JDS	18 poles + ⊕	55
JSH	10 poles + ⊕	63
JNE, JSE	10 poles + ⊕	69
CCE	10 poles + ⊕	75
CQE	18 poles + ⊕	82

insert centre distance:
57 x 27 mm

housings with double lever



hoods with 4 pegs



description	part No.	entry M	part No.	entry M
bulkhead mounting housing with thermoplastic levers	TCHI 10			
surface mounting housing with thermoplastic levers	TMAP 10.25	25		
surface mounting housing with thermoplastic levers	TMAP 10.32	32		
with pegs, side entry			TMAO 10.25	25
with pegs, side entry			TMAO 10.32	32
with pegs, top entry			TMAV 10.25	25
with pegs, top entry			TMAV 10.32	32

panel cut-out for bulkhead mounting housing in mm

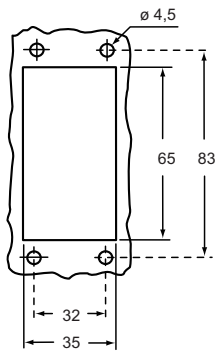

dimensions in mm

TCHI 10

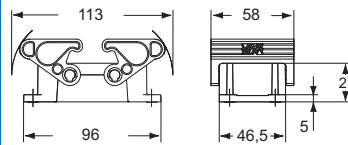

TMAP 10.25 and TMAP 10.32

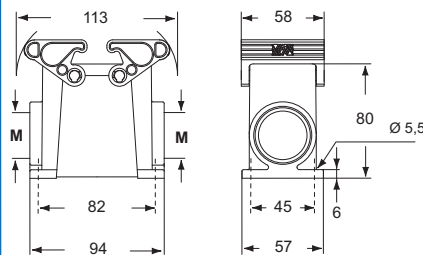

dimensions in mm

TMAO 10.25 and TMAO 10.32

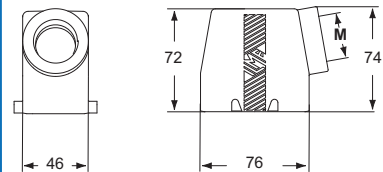

TMAV 10.25 and TMAV 10.32

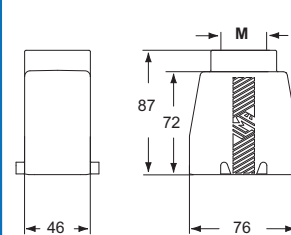

The surface mounting, high construction housings are supplied with an open threaded entry and diametrically opposite a closed threaded entry which can be opened by the user if required (with suitable tool).

CAI[®] US Type 12

EAC



- ambient temperature limits -40 °C / +90 °C.

dimensions shown are not binding
and may be changed without notice

inserts:	page:
CDD 42 poles + ⊕	42
JDS 18 poles + ⊕	55
JSH 10 poles + ⊕	63
JNE, JSE 10 poles + ⊕	69
CCE 10 poles + ⊕	75
CQE 18 poles + ⊕	82

insert centre distance:
57 x 27 mm

hoods with double lever top entry



covers

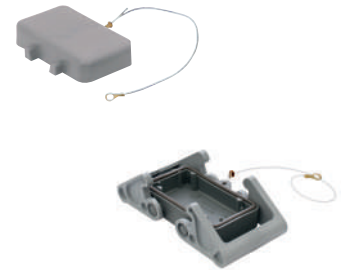

description	part No.	entry M	part No.
with thermoplastic levers and gasket	TMAV 10 G25	25	
with thermoplastic levers and gasket	TMAV 10 G32	32	
with 4 pegs			TCHC 10
with 2 thermoplastic levers and gasket			TCHC 10 G

dimensions in mm

TMAV 10 G25 and TMAV 10 G32

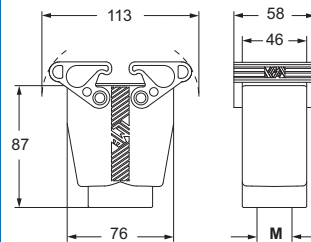

dimensions in mm

TCHC 10

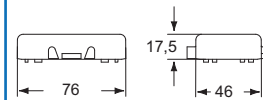

TCHC 10 G

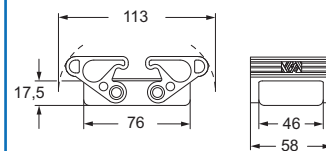

CE [®] **US** Type 12

EAC



- ambient temperature limits -40 °C / +90 °C.

dimensions shown are not binding
and may be changed without notice

inserts: page:

CD	40 poles + ⊕	35
CDD	72 poles + ⊕	43
JDS	27 poles + ⊕	56
JSH	16 poles + ⊕	64
JNE, JSE	16 poles + ⊕	70
CCE	16 poles + ⊕	76
CQE	32 poles + ⊕	83

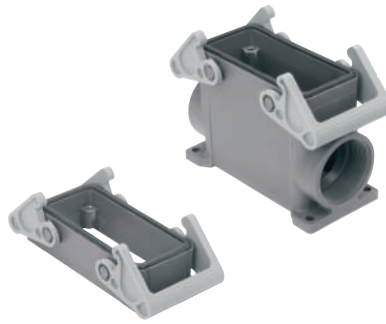
 insert centre distance:
77,5 x 27 mm
housings with double lever

hoods with 4 pegs

description	part No.	entry M	part No.	entry M
bulkhead mounting housing with thermoplastic levers	TCHI 16			
surface mounting housing with thermoplastic levers	TMAP 16.32	32		
surface mounting housing with thermoplastic levers	TMAP 16.40	40		
with pegs, side entry			TMAO 16.32	32
with pegs, side entry			TMAO 16.40	40
with pegs, top entry			TMAV 16.32	32
with pegs, top entry			TMAV 16.40	40

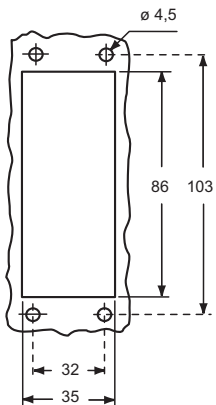
panel cut-out for bulkhead mounting housing in mm

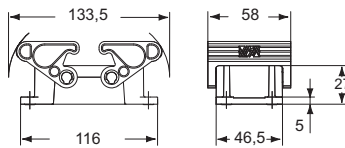
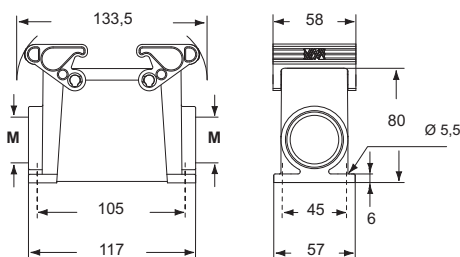

dimensions in mm

TCHI 16

TMAP 16.32 and TMAP 16.40

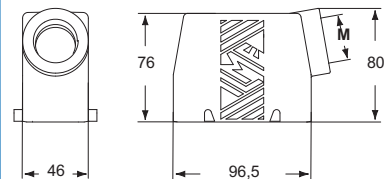
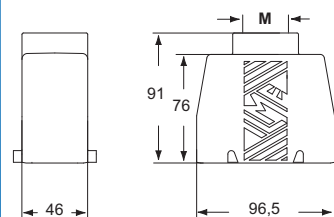
dimensions in mm

TMAO 16.32 and TMAO 16.40

TMAV 16.32 and TMAV 16.40

The surface mounting, high construction housings are supplied with an open threaded entry and diametrically opposite a closed threaded entry which can be opened by the user if required (with suitable tool).

CE **US** Type 12

EAC

- ambient temperature limits -40 °C / +90 °C.

 dimensions shown are not binding
 and may be changed without notice

inserts:	page:	
CD 40 poles + ⊕	35	
CDD 72 poles + ⊕	43	
JDS 27 poles + ⊕	56	
JSH 16 poles + ⊕	64	
JNE, JSE 16 poles + ⊕	70	
CCE 16 poles + ⊕	76	
CQE 32 poles + ⊕	83	

insert centre distance:
77,5 x 27 mm

hoods with double lever top entry



covers

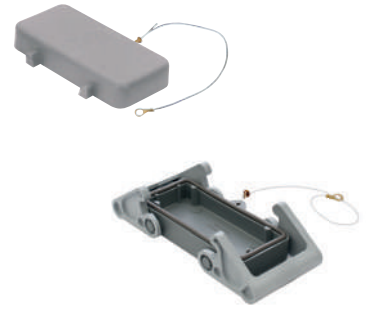

description	part No.	entry M	part No.
with thermoplastic levers and gasket	TMAV 16 G32	32	
with thermoplastic levers and gasket	TMAV 16 G40	40	
with 4 pegs			TCHC 16
with 2 thermoplastic levers and gasket			TCHC 16 G

dimensions in mm

TMAV 16 G32 and TMAV 16 G40

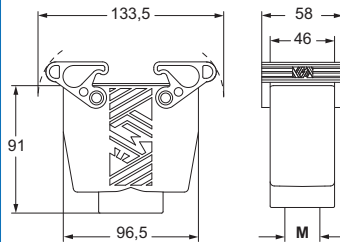

dimensions in mm

TCHC 16

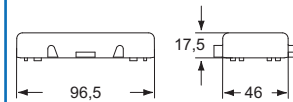

TCHC 16 G

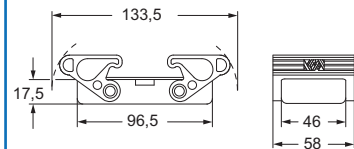

CE **US** Type 12

EAC



- ambient temperature limits -40 °C / +90 °C.

dimensions shown are not binding
and may be changed without notice

inserts: page:

CD	64 poles + ⊕	36
CDD	108 poles + ⊕	44
JDS	42 poles + ⊕	57
JSH	24 poles + ⊕	65
JNE, JSE	24 poles + ⊕	71
CCE	24 poles + ⊕	77
CQE	46 poles + ⊕	84

insert centre distance:
104 x 27 mm

housings with double lever

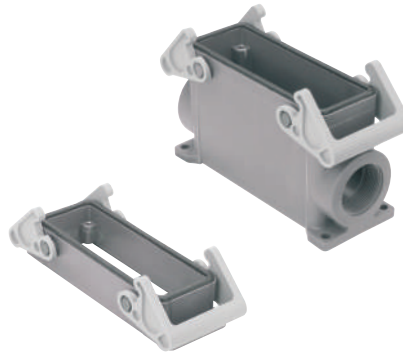

hoods with 4 pegs



description	part No.	entry M	part No.	entry M
bulkhead mounting housing with thermoplastic levers	TCHI 24			
surface mounting housing with thermoplastic levers	TMAP 24.32	32		
surface mounting housing with thermoplastic levers	TMAP 24.40	40		
with pegs, side entry			TMAO 24.32	32
with pegs, side entry			TMAO 24.40	40
with pegs, top entry			TMAV 24.32	32
with pegs, top entry			TMAV 24.40	40

panel cut-out for bulkhead mounting housing in mm

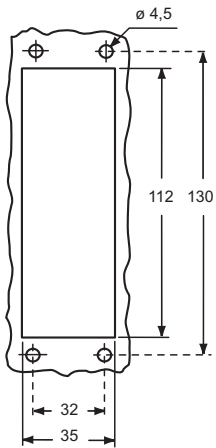

dimensions in mm

TCHI 24

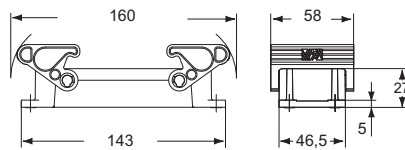

TMAP 24.32 and TMAP 24.40

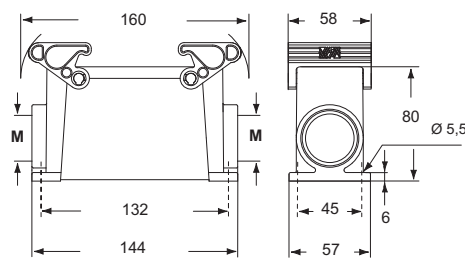

dimensions in mm

TMAO 24.32 and TMAO 24.40

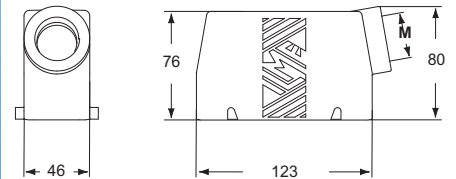

TMAV 24.32 and TMAV 24.40

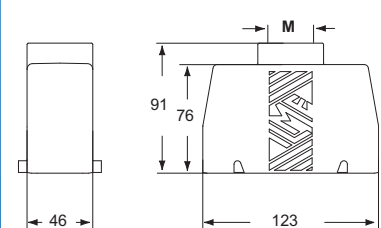

The surface mounting, high construction housings are supplied with an open threaded entry and diametrically opposite a closed threaded entry which can be opened by the user if required (with suitable tool).

CE **UL** **US** Type 12

EAC



- ambient temperature limits -40 °C / +90 °C.

dimensions shown are not binding and may be changed without notice

inserts:	page:	
CD 64 poles + ⊕	36	
CDD 108 poles + ⊕	44	
JDS 42 poles + ⊕	57	
JSH 24 poles + ⊕	65	
JNE, JSE 24 poles + ⊕	71	
CCE 24 poles + ⊕	77	
CQE 46 poles + ⊕	84	

insert centre distance:
104 x 27 mm

hoods with double lever top entry

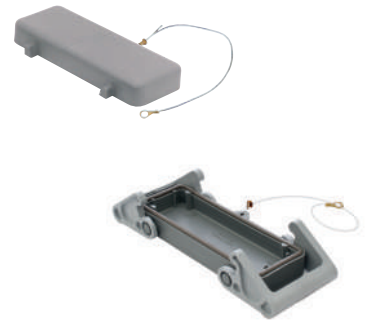
covers

description	part No.	entry M	part No.
with thermoplastic levers and gasket	TMAV 24 G32	32	
with thermoplastic levers and gasket	TMAV 24 G40	40	
with 4 pegs			TCHC 24
with 2 thermoplastic levers and gasket			TCHC 24 G

dimensions in mm

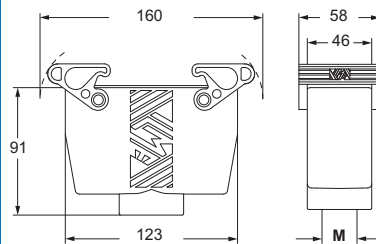
TMAV 24 G32 and TMAV 24 G40

dimensions in mm

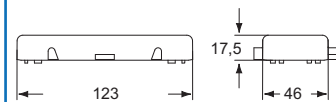
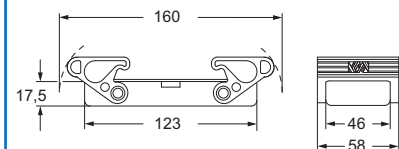
TCHC 24

TCHC 24 G

Type 12



- ambient temperature limits -40 °C / +90 °C.

dimensions shown are not binding
and may be changed without notice

Characteristics

- 1 COB, TSF or COB TSFS insert support blocks (with cable clamp) for mobile mounting, in self-extinguishing thermoplastic material.
- 2 passage for cable support bands (from 2.2 to 4.8 mm).
- 3 locations for insertion of identification tags (size 9 x 20 mm).
- 4 threaded metallic inserts for fixing the inserts with normal screws and possibility of coded connection with the use of specific pins when identical connectors are used.
- 5 COB TCQ insert carrier block for window mounting in self-extinguishing thermoplastic material, with spring snap fastening.
- 6 locking device with levers in self-extinguishing thermoplastic material for insert coupling.
- 7 sturdy cable clamp for clamping multipolar cables with a diameter of up to 25 mm or bundles of unipolar conductors.
- 8 COB...CMS enclosure for mobile mounting, in self-extinguishing thermoplastic material, IP20 protection rating.
- 9 free passage for mounting wired insert with conductor cables.
- 10 mobile blocks (in COB...BC kit) in self-extinguishing thermoplastic material, with quick release device for insert turnover, wiring operations, verifications and maintenance.
- 11 COB...BC panel support for bulkhead mounting in self-extinguishing thermoplastic material, sturdy block support structure, with broad passage for housing of conductor cables.
- 12 holes for fixed fastening with screws without DIN EN 60715 rails.
- 13 snap fastening on DIN EN 60715 rails, both lengthways and crossways to the support Figure 1.
- 14 turnover pins that can be released and allow the use of prewired inserts.

COB...BC + COB...CMS (COB TSF, alternative)

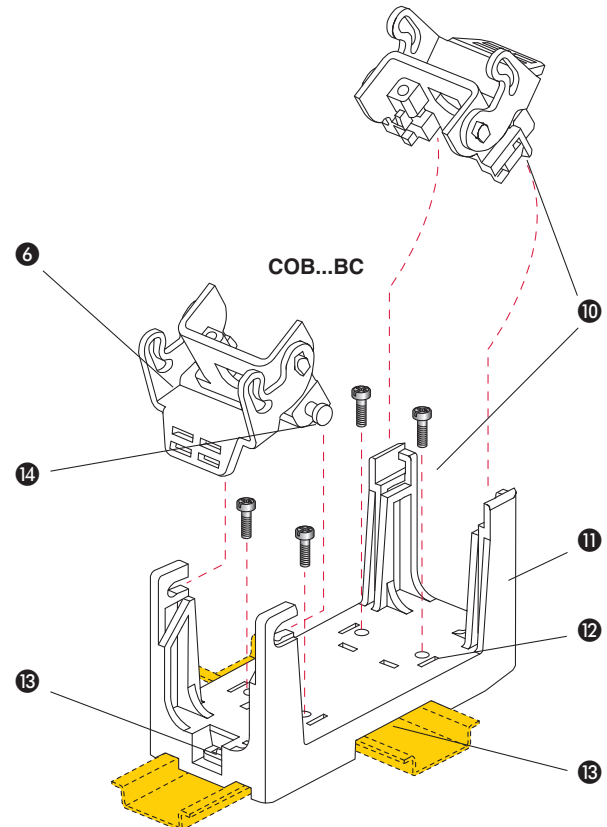
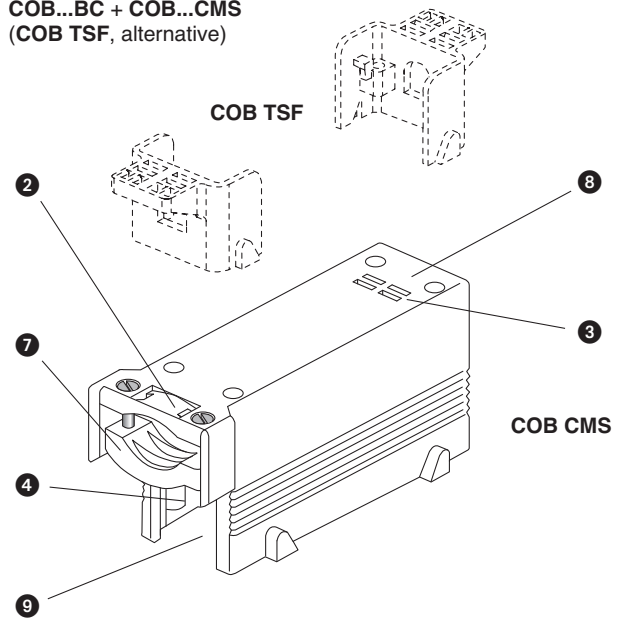

Figure 1:

- snap fastening on DIN EN 60715 rails both lengthways and crossways to the support
- installation in panels or control panels, with fixed fastening with screws

inserts:	page:
CD 40, 64 poles + ⊕	35-36
CDD 24, 42, 72, 108 poles + ⊕	40-44
JDS 9, 18, 27, 42 poles + ⊕	54-57
JSH 6, 10, 16, 24 poles + ⊕	62-65
JNE, JSE 6, 10, 16, 24 poles + ⊕	68-71
CCE 6, 10, 16, 24 poles + ⊕	74-77
CQE 10, 18, 32, 46 poles + ⊕	81-84

insert centre distance:
44 x 27 mm, 57 x 27 mm,
77,5 x 27 mm, 104 x 27 mm

connector carrier for faceplate mounting in window, snap fastening



connector carrier baseplate for mounting on DIN EN 60715 rail or fixed mounting using screws

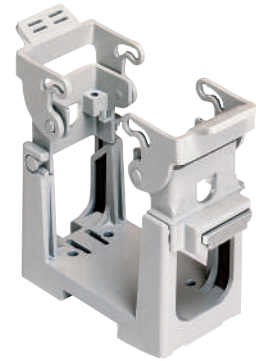

description	part No.	part No.
-------------	----------	----------

kit with 2 elements, for coupling of inserts with screw fixing centre distance (short side = 27 mm)

COB TCQ

kit comprising frame and mobile blocks, for insert coupling:
 - with screw fixing centre distance of 44 x 27 mm
 - with screw fixing centre distance of 57 x 27 mm
 - with screw fixing centre distance of 77,5 x 27 mm
 - with screw fixing centre distance of 104 x 27 mm

COB 06 BC
COB 10 BC
COB 16 BC
COB 24 BC

panel cut-out in mm

dimensions in mm

dimensions in mm

COB TCQ

window size on plate thickness 1,3-3 mm

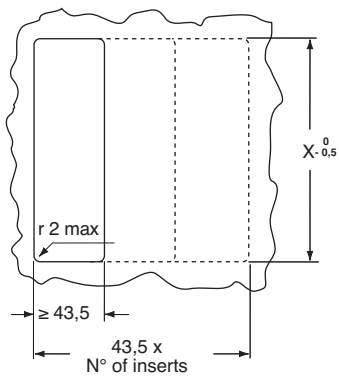

insert coupling:	X_{±0,5}
with centre distance 44 x 27 mm	65
with centre distance 57 x 27 mm	78
with centre distance 77,5 x 27 mm	98
with centre distance 104 x 27 mm	125

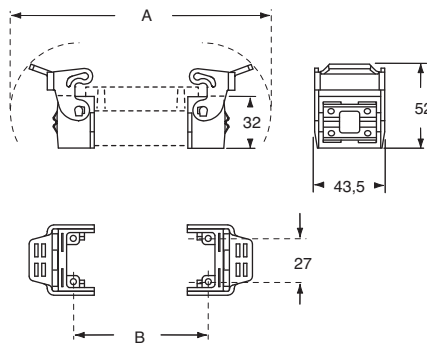

COB TCQ

for inserts	A	B
with centre distance 44 x 27 mm	120	44
with centre distance 57 x 27 mm	133	57
with centre distance 77,5 x 27 mm	153,5	77,5
with centre distance 104 x 27 mm	180	104

overall dimensions with longitudinal DIN rails

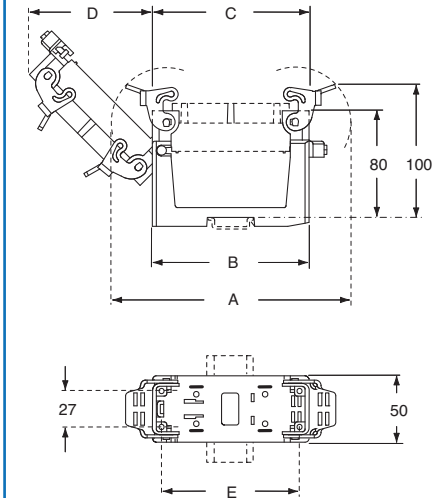

part No.	A	B	C	D	E
COB 06 BC	120	91,5	58	50	44
COB 10 BC	133	91,5	71	59,5	57
COB 16 BC	153,5	91,5	91,5	74	77,5
COB 24 BC	180	118	118	93	104

COB...BC

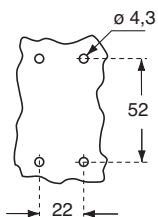

It is the responsibility of the installer to verify the continuity of the PE protective earth circuit ⊕ between the two halves of the connector.

dimensions shown are not binding and may be changed without notice

overall dimensions without DIN rails (values with "asterisk")
 overall dimensions with longitudinal DIN rails

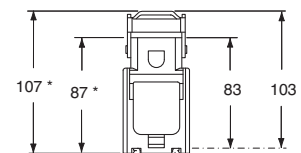

inserts:		page:
CD	40, 64 poles + ⊕	35-36
CDD	24, 42, 72, 108 poles + ⊕	40-44
JDS	9, 18, 27, 42 poles + ⊕	54-57
JSH	6, 10, 16, 24 poles + ⊕	62-65
JNE, JSE	6, 10, 16, 24 poles + ⊕	68-71
CCE	6, 10, 16, 24 poles + ⊕	74-77
CQE	10, 18, 32, 46 poles + ⊕	81-84

insert centre distance:
44 x 27 mm, 57 x 27 mm,
77,5 x 27 mm, 104 x 27 mm

insert carrier blocks for mobile mounting

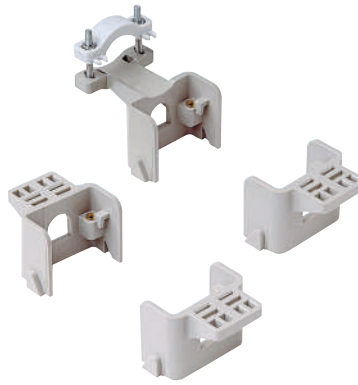

insert carrier insulated enclosures for mobile mounting



description	part No.	part No.
kit with 2 elements, for coupling of inserts with screw fixing centre distance (short side = 27 mm) - with handle for cable support bands - with handle for cable support or cable clamp bands	COB TSF COB TSFS	
side entry, with cable clamp for insert coupling: - with screw fixing centre distance 44 x 27 mm - with screw fixing centre distance 57 x 27 mm - with screw fixing centre distance 77,5 x 27 mm - with screw fixing centre distance 104 x 27 mm		COB 06 CMS COB 10 CMS COB 16 CMS COB 24 CMS

dimensions in mm

COB TSF

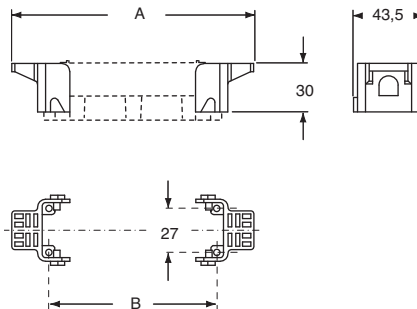

COB TSFS

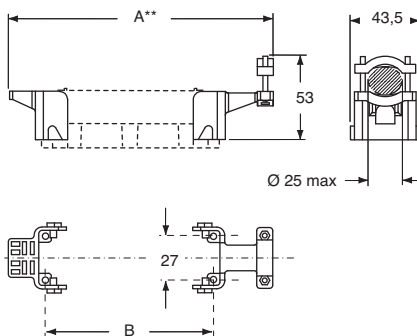

dimensions in mm

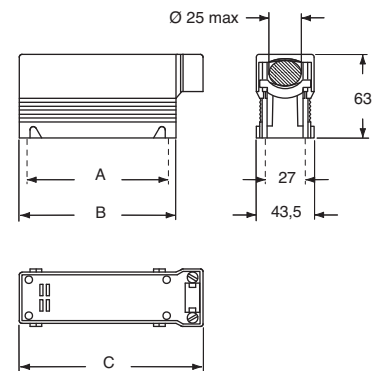

It is the responsibility of the installer to verify the continuity of the PE protective earth circuit ⊕ between the two halves of the connector.

dimensions shown are not binding and may be changed without notice

for inserts	A	A**	B
with centre distance 44 x 27 mm	90	104	44
with centre distance 57 x 27 mm	103	117	57
with centre distance 77,5 x 27 mm	123,5	137,5	77,5
with centre distance 104 x 27 mm	150	164	104

part No.	A	B	C
COB 06 CMS	44	58	74
COB 10 CMS	57	71	87
COB 16 CMS	77,5	91,5	107,5
COB 24 CMS	104	118	134

inserts:		page
CD	15, 25 poles + ⊕	33-34
CDD	38 poles + ⊕	41
JDA	10, 16 poles + ⊕	48-49

insert centre distance:
49,5 x 16 mm
66 x 16 mm

adaptor plates for insert mounting



levers for coupling with metallic enclosures



description	part No.	part No.
mounting on COB series articles (see below) for 1 insert with centre distance of 49,5 x 16 mm	CR 15/16	
mounting on COB series articles (see below) for 1 insert with centre distance of 66 x 16 mm	CR 25/16	
kit with 2 elements, to be mounted instead of the standard levers to be coupled with: COB TCQ and COB...BC ¹⁾		COB L

¹⁾ They allow the mounting of aluminium hoods with 4 pegs, size 55.27, 77.27 and 104.27

dimensions in mm

CR 15/16

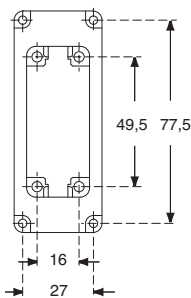

CR 25/16

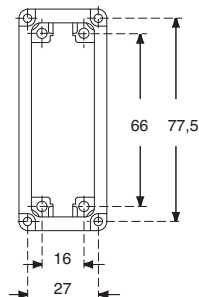

Adaptor plates

- They allow the inserting of inserts of "49.16" and "66.16" on the following COB series articles: COB TCQ, COB 16 BC, COB TSF, COB TSFS, COB 16 CMS

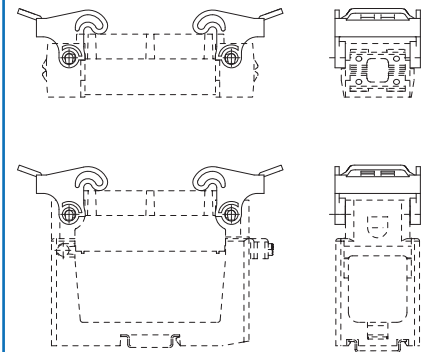

It is the responsibility of the installer to verify the continuity of the PE protective earth circuit ⊕ between the two halves of the connector.

dimensions shown are not binding
and may be changed without notice

single code pins
for 6 codings



selectivity using single code pins

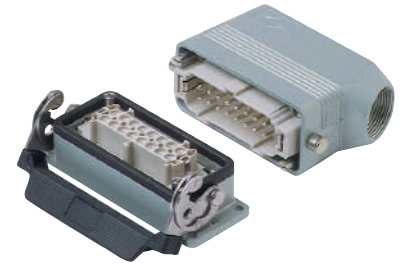

description	part No.
single code pin	zinc plated iron CR 20 D

CR 20 D code pins

Each series of connector inserts is made in such a way as to make incorrect coupling between inserts of different series impossible. When a number of identical connectors with different functions are mounted closely together these must be selected in such a way as to prevent the coupling of a mobile part on a non-corresponding fixed part and consequent damage and breakdown.

Code pins are supplied to apply in place of the normal insert fastening screws (see example below). In this way the coupling of identical connectors is assured. The combination of code pins makes it possible to obtain a high number of selective couplings.

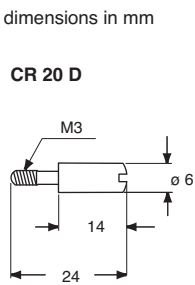

application with single insert

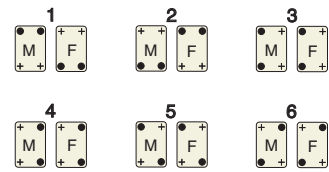

application with double inserts

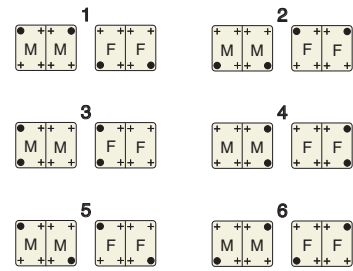

- code pin (CR 20 D)
- + normal fixing screw
- M = male insert
- F = female insert

dimensions shown are not binding and may be changed without notice

double coding and guide pins, for 16 codes



selection is made by using double coding and guide pins

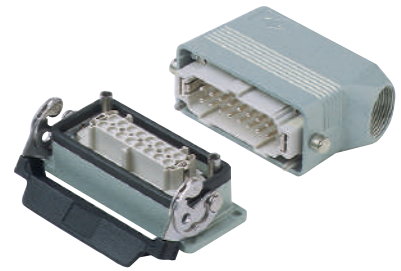

description	part No.
double code pins - male pin - female pin	zinc plated iron CRM D CRF D

Code pins
- CRM D and CRF D

Each series of connector inserts is made in such a way as to make incorrect coupling between inserts of different series impossible. When a number of identical connectors with different functions are mounted closely together these must be selected in such a way as to prevent the coupling of a mobile part on a non-corresponding fixed part and consequent damage and breakdown.

Code pins are supplied to apply in place of the normal insert fastening screws (see example below). In this way the coupling of identical connectors is assured. The combination of code pins makes it possible to obtain a high number of selective couplings.

dimensions in mm

CRM D

CRF D

application with single insert

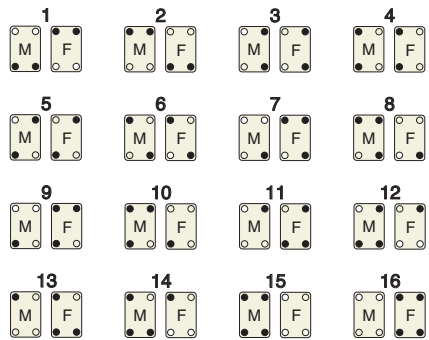

application with double inserts

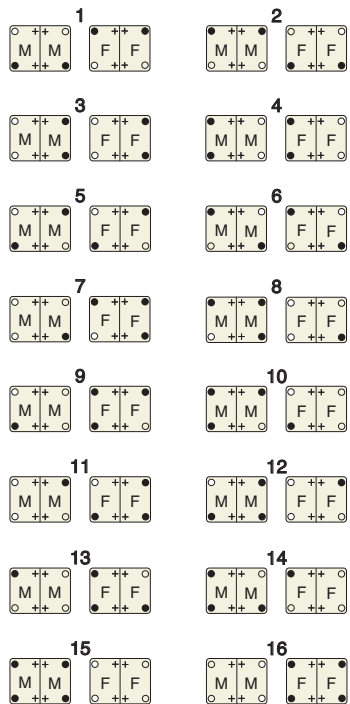

- female code pin (CRF D)
- male code pin (CRM D)
- + normal fixing screw
- M = male insert
- F = female insert

dimensions shown are not binding and may be changed without notice

inserts:		page
CD	40, 64 poles + ⊕	35-36
CDD	24, 42, 72, 108 poles + ⊕	40-44
JSH	6, 10, 16, 24 poles + ⊕	62-65
JNE, JSE	6, 10, 16, 24 poles + ⊕	68-71
CCE	6, 10, 16, 24 poles + ⊕	74-77
CQE	10, 18, 32, 46 poles + ⊕	81-84

screw fixing centre distance:
44 x 27 mm, 57 x 27 mm,
77,5 x 27 mm, 104 x 27 mm

N.B.:
 size 44.27 and 57.27 cannot be used with
T-TYPE series

ground terminals for shielded cables and for several earth connections clamps for cables Ø 5 mm and Ø 10 mm



description	part No.
in zinc plated iron, to be fitted on connectors in bulkhead housings, high hoods and COB series enclosures - "44.27" enclosures and inserts - "57.27" enclosures and inserts * - "77.27", "77.62" enclosures and inserts - "104.27", "104.62" enclosures and inserts - CSS "104.27" enclosures and inserts **	CR 06 SC CR 10 SC CR 16 SC CR 24 SC CR 24 SCA
to be fitted on CR..SC anchors U-bolt for Ø 5 mm cable screening U-bolt for Ø 10 mm cable screening	CR 05 CA CR 10 CA

* the high construction hoods with side entry cannot be used

** can be used only in bulkhead housings

The CR... SC anchors are fitted on connectors for connecting to earth multiple cables and screened cables braids

With the CR..SC anchorages, we advise you to use high construction hoods top entry.

dimensions in mm

CR...SC

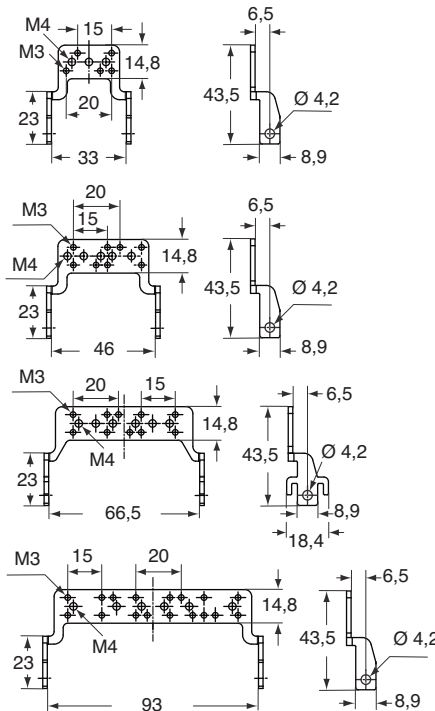

CR...CA

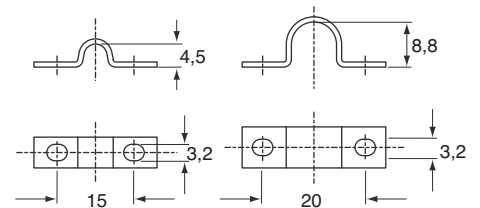

CR SCA

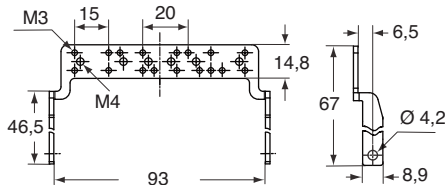

dimensions shown are not binding
 and may be changed without notice

enclosures:

size "44.27", "57.27", "77.27", "104.27"

for versions:

- JEI®-P

- JEI®-V

dust protection cover

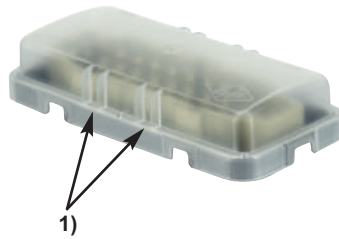

1)

description	part No.
for housings and hoods with 1 or 2 levers, with 2 or 4 pegs - size "44.27" - size "57.27" - size "77.27" - size "104.27"	CHCP 06 CHCP 10 CHCP 16 CHCP 24

1) possibility of using cable ties to increase the retention of the insulating cover on the hood

dimensions in mm

CHCP

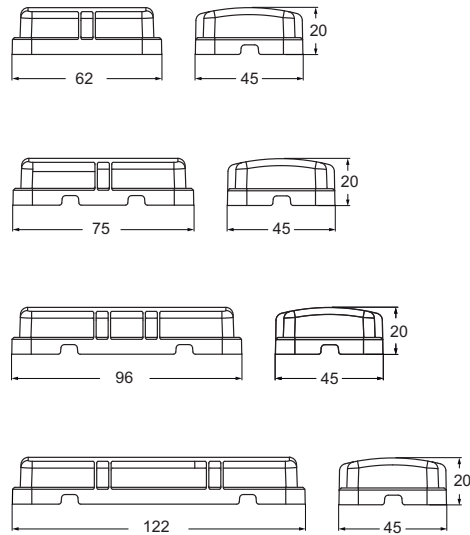

dimensions shown are not binding and may be changed without notice

The crimping concept

The crimp connection is an irreversible connection between one or two conductors and a crimp contact. The crimp connection is obtained by pinching or pressing the contact metal - or shaft - firmly with the crimping tool.

A good crimp connection is provided by a suitable combination between the crimping base, the crimping part of the contact metal, i.e. the crimp contact, firmly with and the section of the conductor.

These comments refer to crimped connections carried out with copper flexible conductors in class 5 (flexible) or 6 (extra flexible) according to standards IEC 60228 and IEC 60228-A (Italian standard CEI 20-29).

Solid copper conductors (class 1) or in other materials (aluminium, iron, etc) often require special precautions for contacts and for crimping tools, to be agreed with the manufacturer.

The main technical advantages provided by crimping connections over soldered connections are:

- The process does not use heat and does not require materials.
- Perfect connection is acquired that is intrinsic with cold soldering.
- No degradation of the elastic characteristics of the female contacts (a problem that arises with soldering temperatures).
- No health risks connected with the use of heavy metals or fumes generated from the soldering process.
- Preservation of the conductor's flexibility immediately upon connection.
- No conductors with burned, discoloured or overheated insulating material.
- Excellent reproducibility of the performances of the electrical and mechanical connections.
- Facilitated production controls.

Other advantages obtained by crimping connections over screw terminal connections are:

- Less drop of currency in the connector contacts.
- High stability in time even in the presence of vibrations.
- High duration in presence of corrosion (gastight).
- Individual insertion of the contacts in the connector (it is possible to eliminate unnecessary contacts).
- Less time required for connection.
- Possibility of pre-production of the terminated conductors with crimp contacts.
- Easy substitution of individual contacts during maintenance.
- Possibility of selectively isolating the circuits during maintenance via the extraction of the contacts from the connector.

The crimped connections for wire sections up to 10 mm² are covered by the EN 60352-2:2006 European standard equivalent to the IEC 60352-2 Issue 2 (2006-02) international standard.

The **EN 60352-2** standard also includes a practical guide, which lists the following main points.

The quality of a crimped connection is mainly affected by the quality of materials used and by the condition of the crimp contact (in particular the crimp shaft) and wire surfaces.

To ensure a good quality crimped connection, an essential parameter is the wire mechanical retention in the contact.

The standard makes a distinction between the closed crimp shaft, inherently stronger, and the open crimp shaft. ILME crimp contacts are closed crimp shaft contacts, with inspection hole which ensures a higher mechanical performance compared to the open shaft crimp contacts, such as better mechanical sturdiness and stability during operation.

They have been machine turned, thus ensuring a better electrical performance (better conductivity).

2002 Amendment 2 of the previous IEC standard issue controversially unified the minimum resistance to tensile stress values established for open shaft contacts (curve B of old Figure 5) and closed shaft contacts (curve A of old Figure 5) by lowering them to the values (shown in curve B), which can be achieved by open shaft crimp contacts.

This has controversially relaxed the suitability requirements both for closed crimp shaft, typically large, machine turned and for crimp tools specially made for these contacts.

Several industries continue to prefer the higher performance ensured by closed shaft crimp contacts, the only ones to ensure the higher resistance to tensile stress values believed to be essential for the most demanding industrial applications.

Therefore, ILME continues to refer to curve A of Figure 5 illustrated in the

EN 60352-2 (1994) standard: ILME closed shaft crimp contacts, used with flexible copper wires, featuring a section included in the ranges shown and correctly crimped with the recommended tools, ensure breakage resistant connections at least equal to the values shown in the table shown below (for reference, the corresponding R_f/S unified tensile stress load value is also shown [N/mm²]).

Section S		Resistance to traction R _t (N)	R _f /S (N/mm ²)
AWG	mm ²		
26	0,12	18	150
-	0,14	21	150
24	0,22	33	150
-	0,25	37,5	150
22	0,32	48	150
-	0,37	55,5	150
20	(0,6)	75	150
-	0,75	112,5	150
18	(0,82)	125	150
-	1	150	150
16	(1,3)	195	150
-	1,5	220	147
14	(2,1)	300	143
-	2,5	325	130
12	(3,3)	430	130
-	4	500	125
10	(5,3)	635	120
-	6	650	108
7	10	1000 <i>(1300)</i>	100 <i>(130)</i>
-	16	<i>1650</i>	<i>103</i>
-	25	<i>2300</i>	<i>92</i>
-	35	<i>2800</i>	<i>80</i>
-	50	<i>3300</i>	<i>66</i>
-	70	<i>3900</i>	<i>56</i>

NOTE - For 10 mm² wire sections, the resistance to tensile stress shown in *italics* are those specified in the NF F 61-030 standard (for 10 mm², the value in brackets)

The basic criteria used for the resistance to tensile stress values required by EN 60352-2 standard is that such resistance is at least equal to 60% of the breakage unified load of the same annealed copper wire.

This applies to wire sections up to about 1.5 mm²; above this section, the ratio is slightly lower as retention is also affected by friction, which increases linearly with the housing diameter, whilst the section increases by the square. IEC/EN 60352-2 standard, which targets the electronics industry, restricts its requirements to crimp connections for wires with a maximum section of 10 mm². For sections higher than 10 mm², up to 70 mm², the standard to refer to is the NF F 61-030 (1989) French standard which relates to electrical connectors to be used on board of railway rolling stock, in particular for large crimp contacts, such as those manufactured by ILME.

NOTE

Alternatively, for wire sections between 35 mm² and 300 mm², EN 61238-1:2003 standard can be referred to.

This standard requires constant R_f/S values equal to 60 N/mm², lower than those established by the above mentioned French standard.

Selecting the crimping tool and relevant controls

When you have selected quality crimp contacts and conductors, the next step and most important step is to select the correct work tool.

The practical guide of standard EN 60352-2 provides the following recommendations on the subject.

They list some of the ideal requirements for crimping tools, some optional characteristics, but, above all, they provide a preview of the indispensable controls:

- a) The crimping tools and the contacts used must be supplied by the same manufacturer, otherwise the user must assume all responsibility for the quality and reliability of the crimp connections.
- b) The crimping tools must function correctly and provide a correct crimp without damage to the pin or the component to crimp.
- c) In order to obtain a reliable crimp connection, a crimping device with a mechanism that controls the entire crimping cycle must be used.
At the end of the crimping cycle the handles and the ratchet must return to the open position.
- d) In all cases the crimping operation must be made in one single phase, with no further interventions.
- e) The removable parts of the tool such as the crimping dies and the locators must be designed in such a way as to make it possible to be inserted within the tool only in the correct manner.
- f) The tools must be supplied with the appropriate means for a correct positioning of the pins to be crimped and of the conductors during crimping.
- g) The tools must be designed in such a way so that only the necessary adjustments may be made.
- h) The action of the tool must be such that both the pin to be crimped and the fixture of the isolation (when present) are respectively crimped or compressed with a single action.
- i) The design of the tool must ensure that the dies for a particular tool may be interchangeable within tools of the same type.
If they are not interchangeable, the identification of tools for which they are suitable must be marked on the dies.
- j) The tools may be designed so as to produce a marking or coding of the die on the pin to be crimped so that the crimping may be checked for verification of the correct die.
- k) The design of the tool must allow the verification of the dies with gauges to measure wear.
The gauge verification method must be that specified by the manufacturer of the tools.

The manual and automatic crimping tools selected by ILME are carefully designed to ensure symmetrical deformation of the crimping area of the contact and wire, by means of their own, internal high pressure forming parts.

The positioner ensures that the wire and crimp contact meet in the appropriate part of the tool.

Sprung mechanisms built into the tools ensure that the contacts are not inserted in the tool before the indenters are fully open, and that the tool does not open before the crimping process has been completed.

The crimping operation

The practical guide in standard EN 60352-2 supplies further general information regarding crimp contacts for multipole connectors.

1. Insertion of the conductor in the crimp contacts

The conductor must be correctly positioned in the pin to be crimped. The crimping indentations must be correctly positioned on the foot to be crimped.

There must be sufficient space, in conformity with the manufacturer's instructions, between the end of the insulating material of the conductor and the pin to be crimped ("d").

As a general rule, the stripping length is equal to the pin insertion depth + 1 mm (for sections up to 1 mm²) and + 2 mm (for sections from 1 to 10 mm²).

When using closed crimp pins with an inspection hole, the crimp conductor must be visible through the inspection holes.

* Keeping the conductor strands visible above the contact collar enables you to check correct stripping, i.e. make sure no strands have been cut. This also ensures a certain flexibility for the connection, by not transmitting to the contact any flexure stresses caused by installation. However, in practice, some operators give priority to insulation, by reducing to zero the gap between cable insulation and the contact collar.

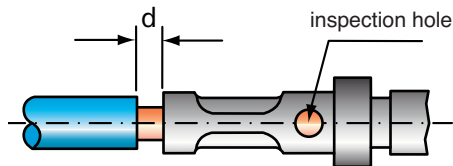

2. Insertion of crimped contacts in the connector insert

It is recommended that the crimped contacts be perfectly straight and inserted within the contact slots in a single operation and without excessive force until a clicking sound is heard.

The correct retention of the contact should be verified with a light pulling of the wire. Non alignment of the crimped contacts must be avoided because this could cause possible loosening of the retention springs and consequently jeopardise the retention of the contact in the insert.

For small section conductors ($\leq 0.35 \text{ mm}^2$) or for specific application, the use of the insertion tool specified by the manufacturer is recommended.

3. Removal of inserted contacts

In the case of incorrect insertion or wiring substitution, inserted contacts may only be removed using the removal tools specified by the manufacturer.

4. Mounting and flexure of multiwired bundles or multipolar cables with crimp contacts

Bundles of conductors or multipolar cables with crimp contacts for multipole connectors must not cause stress to the inserted contacts with their weight as this would cause the contacts to bend over to the coupling area of the connectors and consequently damage them.

The connectors must therefore be provided with cable clamps or the conductor bundles or multipolar cables must be mounted as described in the figures herebelow.

Multipolar cable

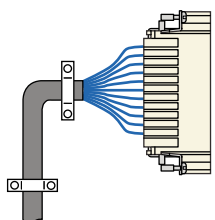

Conductor cables

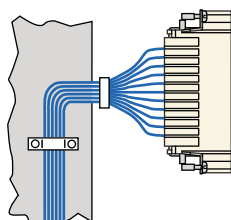

If the conductor bundles or the multipolar cables have to be immediately folded over on the back of the connector insert, it is recommended not to use any mechanical force in the axial direction with respect to the coupled contacts.

The figure herebelow shows a correct bending and clamping of the multiwire bundles using the crimp contacts.

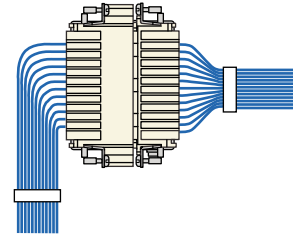

5. Coupling and uncoupling of multipolar connectors with crimp contacts

In order to prevent stress on the crimp contacts, the connectors must be coupled and uncoupled in the axial direction with respect to the contacts, without touching the conductor bundles or cables.

Standard DIN 43652 (incorporated into specification EN 175301-801) that applies to the ILME inserts of the CD series (this recommendation is also valid for the CDD series) prescribes a maximum deflection from the axis of $\pm 5^\circ$ on the greater side and $\pm 2^\circ$ on the smaller side.

correct

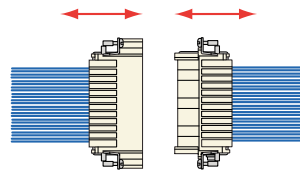

incorrect

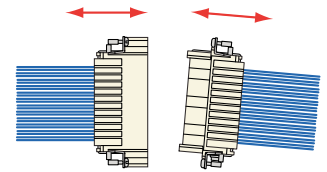

To keep the play within this limit, especially during the uncoupling phase, guide pins CRM and CRF may be used.

for contacts of insert series:	page:
CD (10A)	31-38
CDD (10A)	40-46
CCE (16A)	74-79
CQE (16A)	81-86

manual crimping tool



**insertion tool
removal tools - tip**



description	part No.	part No.
crimping tool for 10A and 16A contacts RENNSTEIG model (turret included)	CCPZ TP	
insertion tool for insertion of the contacts into the inserts for crimped contacts up to 0.75 mm ²		CCINA
removal tools for the extraction of contacts from the inserts - for 10A contacts ¹⁾ - for 16A contacts ²⁾		CCES CQES
replacement tip for CCES removal tool		CCPR RN

Notes:

- ¹⁾ for CD, CDD inserts
- ²⁾ for CQE, CCE inserts

CCPZ TP crimping tool is a simple manual square section crimping tool.
Crimping tools CCPZ RN and CCPZ MIL are recommended for precision crimping.

CCPZ TP

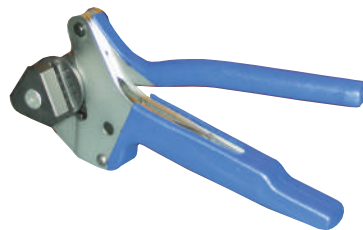

General

Load curves

The permitted current carrying capacity for connectors is variable: it becomes lower with the increase of the number of poles and of the ambient temperature in which the connector is installed and it depends upon the thermal properties of the material used for the contacts and the insulating parts including those of the type of conductor used.

The current carrying capacity is obtained from the load curves which are constructed according to standard IEC 60512-5-2 for currents circulating simultaneously in all poles.

The limit current curves express current values that determine the achievement of the upper limit temperature of the materials. The choice of the permanent load applicable on the contacts must be made within the field of operation possible delimited by the above mentioned curves.

Since use of connectors at the limit values of their characteristics is not recommended, **the base curve** is de-rated. The reduction of the load currents to 80% defines the correction curve where both the maximum permissible contact resistances and the inaccuracy of the temperature measurements are sufficiently taken into consideration.

The correction curve represents the final **limit current curve (load curve)** as defined by standard IEC 60512-5-2. It therefore bears in consideration the differences between the various connector inserts, as well as errors in the temperature measurements.

All the load curves presented here below include the correction.

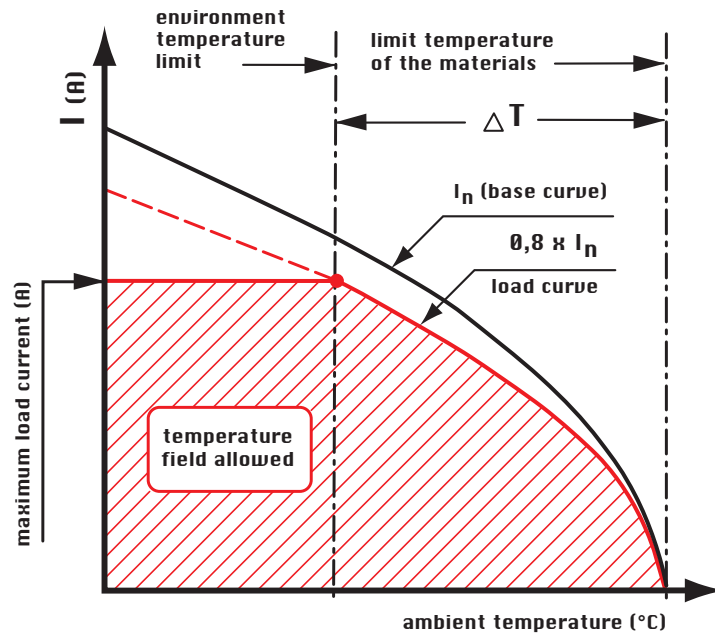

Legend:

Maximum load current (A): value for which the connector reaches the upper limit temperature of the material at the corresponding ambient temperature intersected on the load curve.

Upper limit temperature of the materials: value determined by the characteristics of the material used. The sum of the environmental temperature and the increase of the ΔT (temperature rise) caused by the current flow must not exceed the limit temperature of the materials.

Environment temperature limit: the environmental conditions must not exceed this value. It may be known and determines the maximum load current, or it may be directly obtained from the load curve.

Base curve: set of current and temperature values obtained from laboratory tests and influenced by the connector's characteristics (number of poles, construction shape, thermal conductivity of the materials, etc.) and the cross-section of the conductor used.

Load curve (limit current curve): obtained from the base curve via the safety coefficient.

ΔT (temperature rise): temperature rise produced by a permanent current circulating through all the poles of a connector coupling; difference between the upper limit temperature of the material and the ambient temperature obtained on the limit current curve.

Part No.	page	Part No.	page	Part No.	page
CAO 10.21	95-108	CDDF 108	44-46	CFV 24.21	99
CAO 10.29	95-108	CDDF 108 N	46	CFV 24.29	99
CAO 10 L21	108	CDDF 24	40	CFV 32.29	101
CAO 10 L29	108	CDDF 38	41	CFV 32.36	101
CAO 16.21	97-113	CDDF 42	42	CFV 32 L	121
CAO 16.29	97-113	CDDF 72	43-45	CFV 48 L	122
CAO 16 L21	113	CDDF 72 N	45	CFV 48 L29	122
CAO 16 L29	113	CDDM 108	44-46	CFV 48 L42	122
CAO 24.21	99-118	CDDM 108 N	46	CHC 06 L	93-104
CAO 24.29	99-118	CDDM 24	40	CHC 10	95-109
CAO 24 L21	118	CDDM 38	41	CHC 10 L	109
CAO 24 L29	118	CDDM 42	42	CHC 16	97-114
CAV 10.21	95-108	CDDM 72	43-45	CHC 16 L	114
CAV 10.29	95-108	CDDM 72 N	45	CHC 24	99-119
CAV 10 L21	108	CDF 07	31	CHC 24 L	119
CAV 10 L29	108	CDF 07 N	31	CHC 32	101
CAV 16.21	97-113	CDF 08	32	CHC 32 L	121
CAV 16.29	97-113	CDF 15	33	CHCP 06	149
CAV 16 L21	113	CDF 25	34	CHCP 10	149
CAV 16 L29	113	CDF 40	35-37	CHCP 16	149
CAV 24.21	99-118	CDF 64	36-38	CHCP 24	149
CAV 24.29	99-118	CDFJD 0.3	31*	CHO 06 L13	93-104
CAV 24 L21	118	CDFJD 0.5	31*	CHO 06 L16	93-104
CAV 24 L29	118	CDFJD 0.7	31*	CHO 10	95-108
CCEF 06	74	CDFJD 1.0	31*	CHO 10 L	108
CCEF 10	75	CDFJD 1.5	31*	CHO 16	97-113
CCEF 16	76-78	CDFJD 2.5	31*	CHO 16 L	113
CCEF 16 N	78	CDFS 0.3	31*	CHO 24	99-118
CCEF 24	77-79	CDFS 0.5	31*	CHO 24 L	118
CCEF 24 N	79	CDFS 0.7	31*	CHV 06 L13	93-104
CCEM 06	74	CDFS 1.0	31*	CHV 06 L16	93-104
CCEM 10	75	CDFS 1.5	31*	CHV 10	95-108
CCEM 16	76-78	CDFS 2.5	31*	CHV 10 L	108
CCEM 16 N	78	CDM 07	31	CHV 16	97-113
CCEM 24	77-79	CDM 07 N	31	CHV 16 L	113
CCEM 24 N	79	CDM 08	32	CHV 24	99-118
CCES	153	CDM 15	33	CHV 24.29	99-118
CCFJD 0.3	74*	CDM 25	34	CHV 24 L	118
CCFJD 0.5	74*	CDM 40	35-37	CHV 24 L29	118
CCFJD 0.7	74*	CDM 64	36-38	CK 03 C	124
CCFJD 1.0	74*	CDMJJD 0.3	31*	CK 03 CA	124
CCFJD 1.5	74*	CDMJJD 0.5	31*	CK 03 CAN	124
CCFJD 2.5	74*	CDMJJD 0.7	31*	CK 03 CN	124
CCFJD 3.0	74*	CDMJJD 1.0	31*	CK 03 CX	124
CCFJD 4.0	74*	CDMJJD 1.5	31*	CK 03 CXA	124
CCFS 0.3	74*	CDMJJD 2.5	31*	CK 03 CXAN	124
CCFS 0.5	74*	CDMS 0.3	31*	CK 03 CXN	124
CCFS 0.7	74*	CDMS 0.5	31*	CK 03 I	123
CCFS 1.0	74*	CDMS 0.7	31*	CK 03 IA	123
CCFS 1.5	74*	CDMS 1.0	31*	CK 03 IAN	123
CCFS 2.5	74*	CDMS 1.5	31*	CK 03 IAPNS	123
CCFS 3.0	74*	CDMS 2.5	31*	CK 03 IAPS	123
CCFS 4.0	74*	CFO 06 L21	93-104	CK 03 IN	123
CCINA	153	CFO 06 L29	93-104	CK 03 VAS	124
CCMJD 0.3	74*	CFO 10.21	95	CK 03 VANS	124
CCMJD 0.5	74*	CFO 10.29	95	CK 03 VGS	124
CCMJD 0.7	74*	CFO 16.21	97	CK 03 VGNS	124
CCMJD 1.0	74*	CFO 16.29	97	CK 03 VNS	124
CCMJD 1.5	74*	CFO 24.21	99	CK 03 VS	124
CCMJD 2.5	74*	CFO 24.29	99	CKA 03 APS	125
CCMJD 3.0	74*	CFO 32.29	101	CKA 03 C	127
CCMJD 4.0	74*	CFO 32.36	101	CKA 03 CA	127
CCMS 0.3	74*	CFO 32 L	121	CKA 03 I	125
CCMS 0.5	74*	CFO 48 L	122	CKA 03 IA	125
CCMS 0.7	74*	CFO 48 L29	122	CKA 03 IAPS	125
CCMS 1.0	74*	CFO 48 L42	122	CKA 03 ILS	126
CCMS 1.5	74*	CFV 06 L21	93-104	CKA 03 ILSA	126
CCMS 2.5	74*	CFV 06 L29	93-104	CKA 03 VAS	127
CCMS 3.0	74*	CFV 10.21	95	CKA 03 VGS	127
CCMS 4.0	74*	CFV 10.29	95	CKA 03 VS	127
CCPR RN	153	CFV 16.21	97	CKR 65	123-124-125-126-127
CCPZ TP	153	CFV 16.29	97	CKR 65 D	123-124-125-126-127

* These items are also shown in various sections throughout the catalogue.



Part No.	page	Part No.	page	Part No.	page
COB 06 BC	143	JCVAP 06 LP	103	JKM 04	27
COB 06 CMS	144	JCVAP 06 LP2	103	JKSF 03	29
COB 10 BC	143	JCVAP 10.21	106	JKSF 04	29
COB 10 CMS	144	JCVAP 10.221	106	JKSM 03	29
COB 16 BC	143	JCVAP 10 L21	107	JKSM 04	29
COB 16 CMS	144	JCVAP 10L221	107	JNEF 06	68
COB 24 BC	143	JCVAP 10LP21	107	JNEF 10	69
COB 24 CMS	144	JCVAP10LP221	107	JNEF 16	70-72
COB L	145	JCVAP 16.29	111	JNEF 16 N	72
COB TCQ	143	JCVAP 16.229	111	JNEF 24	71-73
COB TSF	144	JCVAP 16 L29	112	JNEF 24 N	73
COB TSFS	144	JCVAP 16L229	112	JNEM 06	68
CQEF 10	81	JCVAP 16LP29	112	JNEM 10	69
CQEF 18	82	JCVAP16LP229	112	JNEM 16	70-72
CQEF 32	83-85	JCVAP 24.29	116	JNEM 16 N	72
CQEF 32 N	85	JCVAP 24.229	116	JNEM 24	71-73
CQEF 46	84-86	JCVAP 24 L29	117	JNEM 24 N	73
CQEF 46 N	86	JCVAP 24L229	117	JMHP 32 L240	120
CQEM 10	81	JCVAP 24LP29	117	JMHP 32 L250	120
CQEM 18	82	JCVAP24LP229	117	JMHP 32 L40	120
CQEM 32	83-85	JCVI 06 L	102	JMHP 32 L50	120
CQEM 32 N	85	JCVI 06 LP	102	JMHP 32 LP40	120
CQEM 46	84-86	JCVI 10	105	JMHP 32 LP50	120
CQEM 46 N	86	JCVI 10 L	105	JMHP 32LP240	120
CQES	153	JCVI 10 LP	105	JMHP 32LP250	120
CR 05 CA	148	JCVI 16	110	JMHP 48 L40	122
CR 06 SC	148	JCVI 16 L	110	JMHP 48 L50	122
CR 10 CA	148	JCVI 16 LP	110	JMHP 48 LP40	122
CR 10 SC	148	JCVI 24	115	JMHP 48 LP50	122
CR 15/16	145	JCVI 24 L	115	JMPAP 06 L32	92
CR 16 SC	148	JCVI 24 LP	115	JMPAP 06L232	92
CR 20 D	146	JCVI 24 L2	115	JMPAP 10.232	94
CR 24 SC	148	JCVI 24 L2	103	JMPAP 10.32	94
CR 24 SCA	148	JCVI 24 LP	103	JMPAP 16.232	96
CR 25/16	145	JCVI 24 LP2	103	JMPAP 16.32	96
CR K03	26	JCVI 10	106	JMPAP 24.232	98
CR K04G	26	JCVI 10.2	106	JMPAP 24.32	98
CR K04R	26	JCVI 10 L	107	JMPAP 24.32	98
CRF D	147	JCVI 10 L2	107	JMPFV 32 G40	101
CRM D	147	JCVI 10 LP	107	JMPP 06 L20	92
CZC 15 L	89	JCVI 10 LP2	107	JMPP 06 L220	92
CZC 25 L	91	JCVI 16	111	JMPP 10.20	94
CZFO 15 L16	89	JCVI 16.2	111	JMPP 10.220	94
CZFO 15 L21	89	JCVI 16 L	112	JMPP 15 L25	88
CZFO 25 L16	91	JCVI 16 L2	112	JMPP 15 L225	88
CZFO 25 L21	91	JCVI 16 LP	112	JMPP 16.225	96
CZFO 25 L21	91	JCVI 16 LP2	112	JMPP 16.25	96
CZFO 25 L21	91	JCVI 16 LP2	112	JMPP 24.225	98
CZFO 25 L21	91	JCVI 24	116	JMPP 24.25	98
CZFO 25 L21	91	JCVI 24.2	116	JMPP 25 L225	90
CZO 15 L	89	JCVI 24 L	117	JMPP 25 L25	90
CZO 25 L	91	JCVI 24 L2	117	JMPP 32.240	100
CZV 15 L	89	JCVI 24 LP	117	JMPP 32.40	100
CZV 25 L	91	JCVI 24 LP2	117	JMPV 06 LG25	93
JCHI 32 L	120	JDAF 10	48	JMPV 10 G25	95
JCHI 32 LP	120	JDAM 10	48	JMPV 15 LG20	89
JCHI 48 L	122	JDAF 16	49	JMPV 16 G32	97
JCHI 48 LP	122	JDAM 16	49	JMPV 24 G32	99
JCHP 32 L229	120	JDSF 09	54	JMPV 25 LG20	91
JCHP 32 L236	120	JDSF 18	55	JMVAP 06L232	103
JCHP 32 L29	120	JDSF 27	56-58	JMVAP 06 L32	103
JCHP 32 L36	120	JDSF 27 N	58	JMVAP06LP232	103
JCHP 32 LP2	120	JDSF 42	57-59	JMVAP 06 LP32	103
JCHP 32LP229	120	JDSF 42 N	59	JMVAP 10.232	106
JCHP 32 LP29	120	JDSM 09	54	JMVAP 10.32	106
JCHP 32 LP36	120	JDSM 18	55	JMVAP 10L232	107
JCHP 48 L29	122	JDSM 27	56-58	JMVAP 10 L32	107
JCHP 48 L36	122	JDSM 27 N	58	JMVAP10LP232	107
JCHP 48 LP29	122	JDSM 42	57-59	JMVAP 10LP32	107
JCHP 48 LP36	122	JDSM 42 N	59	JMVAP 16.232	111
JCVAP 06 L	103	JKF 03	27	JMVAP 16.32	111
JCVAP 06 L2	103	JKF 04	27	JMVAP 16L232	112
		JKM 03	27	JMVAP 16 L32	112

Part No.	page	Part No.	page	Part No.	page
JMVAP16LP232.....	112	JPV 06 LG16.....	93	MFV 16.40.....	97
JMVAP 16LP32.....	112	JPV 10 G16.....	95	MFV 24.32.....	99
JMVAP 24.232.....	116	JPV 16 G21.....	97	MFV 24.40.....	99
JMVAP 24.32.....	116	JPV 24 G21.....	99	MFV 32.32.....	101
JMVAP 24L232.....	117	JPV 25 LG16.....	91	MFV 32.40.....	101
JMVAP 24 L32.....	117	JSEF 06.....	68	MFV 32 L40.....	121
JMVAP24LP232.....	117	JSEF 10.....	69	MFV 48 L32.....	122
JMVAP 24LP32.....	117	JSEF 16.....	70-72	MFV 48 L40.....	122
JMVP 06 L20.....	103	JSEF 16 N.....	72	MFV 48 L50.....	122
JMVP 06 L220.....	103	JSEF 24.....	71-73	MHO 06 L20.....	93-104
JMVP 06 LP20.....	103	JSEF 24 N.....	73	MHO 06 L25.....	93-104
JMVP 06LP220.....	103	JSEM 06.....	68	MHO 10.20.....	95-108
JMVP 10.20.....	106	JSEM 10.....	69	MHO 10.25.....	95-108
JMVP 10.220.....	106	JSEM 16.....	70-72	MHO 10 L20.....	108
JMVP 10 L20.....	107	JSEM 16 N.....	72	MHO 10 L25.....	108
JMVP 10 L220.....	107	JSEM 24.....	71-73	MHO 16.25.....	97-113
JMVP 10 LP20.....	107	JSEM 24 N.....	73	MHO 16.32.....	97-113
JMVP 10LP220.....	107	JSHF 06.....	62	MHO 16 L25.....	113
JMVP 16.25.....	111	JSHF 10.....	63	MHO 16 L32.....	113
JMVP 16.225.....	111	JSHF 16.....	64-66	MHO 24.25.....	99-118
JMVP 16 L25.....	112	JSHF 16 N.....	66	MHO 24.32.....	99-118
JMVP 16 L225.....	112	JSHF 24.....	65-67	MHO 24 L25.....	118
JMVP 16 LP25.....	112	JSHF 24 N.....	67	MHO 24 L32.....	118
JMVP 16LP225.....	112	JSHM 06.....	62	MHV 06 L20.....	93-104
JMVP 24.25.....	116	JSHM 10.....	63	MHV 06 L25.....	93-104
JMVP 24.225.....	116	JSHM 16.....	64-66	MHV 10.20.....	95-108
JMVP 24 L25.....	117	JSHM 16 N.....	66	MHV 10.25.....	95-108
JMVP 24 L225.....	117	JSHM 24.....	65-67	MHV 10 L20.....	108
JMVP 24 LP25.....	117	JSHM 24 N.....	67	MHV 10 L25.....	108
JMVP 24LP225.....	117	MAO 10.32.....	95-108	MHV 16.25.....	97-113
JPAP 06 L21.....	92	MAO 10.40.....	95-108	MHV 16.32.....	97-113
JPAP 06 L221.....	92	MAO 10 L32.....	108	MHV 16 L25.....	113
JPAP 10.21.....	94	MAO 10 L40.....	108	MHV 16 L32.....	113
JPAP 10.221.....	94	MAO 16.32.....	97-113	MHV 24.25.....	99-118
JPAP 16.229.....	96	MAO 16.40.....	97-113	MHV 24.32.....	99-118
JPAP 16.29.....	96	MAO 16 L32.....	113	MHV 24.40.....	99-118
JPAP 24.229.....	98	MAO 16 L40.....	113	MHV 24 L25.....	118
JPAP 24.29.....	98	MAO 24.32.....	99-118	MHV 24 L32.....	118
JPC 06 LG.....	93	MAO 24.40.....	99-118	MHV 24 L40.....	118
JPC 10 G.....	95	MAO 24 L32.....	118	MK IAP20.....	123
JPC 15 LG.....	89	MAO 24 L40.....	118	MK IAPN20.....	123
JPC 16 G.....	97	MAV 10.32.....	95-108	MK V20.....	124
JPC 24 G.....	99	MAV 10.40.....	95-108	MK VA20.....	124
JPC 25 LG.....	91	MAV 10 L32.....	108	MK VAN20.....	124
JPC 32 G.....	101	MAV 10 L40.....	108	MK VG20.....	124
JPFV 32 G36.....	101	MAV 16.32.....	97-113	MK VGN20.....	124
JPI 06 L.....	92	MAV 16.40.....	97-113	MK VN20.....	124
JPI 10.....	94	MAV 16 L32.....	113	MKA AP20.....	125
JPI 15 L.....	88	MAV 16 L40.....	113	MKA IAF20.....	126
JPI 16.....	96	MAV 24.32.....	99-118	MKA IAF25.....	126
JPI 24.....	98	MAV 24.40.....	99-118	MKA IAP20.....	125
JPI 25 L.....	90	MAV 24 L32.....	118	MKA V20.....	127
JPI 32.....	100	MAV 24 L40.....	118	MKA VA20.....	127
JPP 06 L16.....	92	MFO 06 L25.....	93-104	MKA VG20.....	127
JPP 06 L216.....	92	MFO 06 L32.....	93-104	MZFO 15 L20.....	89
JPP 10.16.....	94	MFO 10.32.....	95	MZFO 15 L25.....	89
JPP 10.216.....	94	MFO 10.40.....	95	MZFO 25 L20.....	91
JPP 15 L16.....	88	MFO 16.32.....	97	MZFO 25 L25.....	91
JPP 15 L21.....	88	MFO 16.40.....	97	MZFO 25 L25.....	91
JPP 15 L216.....	88	MFO 24.32.....	99	MZFO 25 L25.....	91
JPV 15 LG13.....	89	MFO 24.40.....	99	MZFV 15 L20.....	89
JPP 16.21.....	96	MFO 32.32.....	101	MZFV 15 L25.....	89
JPP 16.221.....	96	MFO 32.40.....	101	MZFV 25 L20.....	91
JPP 24.21.....	98	MFO 32 L40.....	121	MZFV 25 L25.....	91
JPP 24.221.....	98	MFO 48 L32.....	122	MZO 15 L20.....	89
JPP 25 L16.....	90	MFO 48 L40.....	122	MZO 15 L25.....	89
JPP 25 L21.....	90	MFO 48 L50.....	122	MZO 25 L20.....	91
JPP 25 L216.....	90	MFV 06 L25.....	93-104	MZO 25 L25.....	91
JPP 32.236.....	100	MFV 06 L32.....	93-104	MZV 15 L20.....	89
JPP 32.229.....	100	MFV 10.32.....	95	MZV 25 L20.....	91
JPP 32.29.....	100	MFV 10.40.....	95	TCHC 06 L.....	135
JPP 32.36.....	100	MFV 16.32.....	97	TCHC 06 LG.....	135
				TCHC 10.....	137
				TCHC 10 G.....	137



Part No.	page	Part No.	page	Part No.	page
TCHC 16	139				
TCHC 16 G	139				
TCHC 24	141				
TCHC 24 G	141				
TCHI 06 L	134				
TCHI 10	136				
TCHI 16	138				
TCHI 24	140				
TMAO 06 L25	134				
TMAO 06 L32	134				
TMAO 10.25	136				
TMAO 10.32	136				
TMAO 16.32	138				
TMAO 16.40	138				
TMAO 24.32	140				
TMAO 24.40	140				
TMAP 06 L25.....	134				
TMAP 06 L32.....	134				
TMAP 10.25.....	136				
TMAP 10.32.....	136				
TMAP 16.32.....	138				
TMAP 16.40.....	138				
TMAP 24.32.....	140				
TMAP 24.40.....	140				
TMAV 06 L25.....	134				
TMAV 06 L32.....	134				
TMAV 06 LG25	135				
TMAV 06 LG32	135				
TMAV 10.25.....	136				
TMAV 10.32.....	136				
TMAV 10 G25	137				
TMAV 10 G32	137				
TMAV 16.32.....	138				
TMAV 16.40.....	138				
TMAV 16 G32	139				
TMAV 16 G40	139				
TMAV 24.32.....	140				
TMAV 24.40.....	140				
TMAV 24 G32	141				
TMAV 24 G40	141				

www.ilme.com



catalogues

XDG JEI 415 - issue 822